

---

GEORGIA  
STORMWATER MANAGEMENT MANUAL  
2016 EDITION

VOLUMES 1 & 2

The revision of this Manual was facilitated by the Atlanta Regional Commission and was a collaborative effort led by the following agencies:

American Rivers  
Atlanta Regional Commission  
Chatham County – Savannah Metropolitan Planning Commission  
City of Atlanta  
City of Cornelia  
City of Garden City  
City of Johns Creek  
City of Roswell  
City of Savannah  
City of Statesboro  
City of Valdosta  
Council for Quality Growth  
Douglasville/Douglas Co. Water & Sewer Authority  
Georgia Department of Transportation  
Georgia Environmental Finance Authority  
Georgia Environmental Protection Division  
Georgia Industry Environmental Coalition  
Gwinnett County  
Mercer University  
The Conservation Fund  
United States Environmental Protection Agency  
University of Georgia

*This project was financed in part through a grant from the U.S. Environmental Protection Agency under the Provisions of Section 319(h) of the Federal Water Pollution Control Act, as amended.*

PREPARED BY:

AECOM Atlanta Regional Commission Center for Watershed Protection Center Forward Georgia Environmental Protection Division Mandel Design



# Forward

## Preface

Stormwater management has entered a new phase in the state of Georgia that recognizes the need for more innovative policies and practices. The requirements for National Pollutant Discharge Elimination System (NPDES) municipal and industrial permits, Total Maximum Daily Loads (TMDLs), watershed assessments and the desire to protect and increase the quality of human life, property, and aquatic habitats has brought home the pressing need to manage both stormwater quantity and quality from our developed and developing areas.

This Manual will continue to help Georgia move forward with a comprehensive approach to stormwater management that integrates drainage design, stormwater quantity, and water quality considerations and views stormwater as an important resource and opportunity for our communities. Building on the previous version, the goal of this Manual continues to be to refine and promote a consistent and effective approach of stormwater management throughout Georgia.

## Acknowledgements

This Manual is the culmination of a collaborative effort between the Atlanta Regional Commission (ARC), the Georgia Environmental Protection Division, Georgia Environmental Finance Authority, cities, counties, and other organizations throughout the state of Georgia. These documents reflect the hard work, time and contributions of many individuals.

The cities, counties, and other organizations involved in this Manual update that helped guide this effort via the Technical Advisory Group (TAG), include:

American Rivers  
Chatham County – Savannah Metropolitan Planning Commission  
City of Atlanta  
City of Cornelia  
City of Garden City  
City of Johns Creek  
City of Roswell  
City of Savannah  
City of Statesboro  
City of Valdosta  
Council for Quality Growth  
Douglasville/Douglas Co. Water & Sewer Authority  
Georgia Department of Transportation  
Georgia Environmental Finance Authority  
Georgia Environmental Protection Division  
Georgia Industry Environmental Coalition  
Gwinnett County  
Mercer University  
The Conservation Fund  
United States Environmental Protection Agency  
University of Georgia

This project was also made possible in part through a U.S. EPA 319(h) grant administered through the Georgia Environmental Protection Division as well as funding provided by the Georgia Environmental Finance Authority.

The Manual management team, production team leads, and principle contributors for Volumes 1 and 2 include:

- **Chris Faulkner** (Atlanta Regional Commission), Project Manager
- **Charles Crowell** (AECOM), Contractor Project Manager
- **Greg Hoffman** (Center for Watershed Protection), Volume 1 Team Lead
- **John Ricketts** (AECOM), Volume 2 Team Lead
- **Principle Contributors:**
  - Adam Borsch (AECOM)
  - Ari Daniels (CWP)
  - Ashley Folmar (AECOM)
  - Aynsley O'Brien (AECOM)
  - Carly Queen (AECOM)
  - Chris Swann (CWP)
  - Daniel Sturdevant (AECOM)
  - David Hirschman (CWP)
  - Heather Alhadeff (Center Forward)
  - Jennifer Kowal (Center Forward)
  - Laurel Williamson (CWP)
  - Rachel Sills (AECOM)
  - Roger Cox (AECOM)
  - Stephanie Smith (ARC)
  - Tanya Mandel (Mandel Design)

## Forward (con't)

Thanks to the members of the TAG which met regularly over the course of a year to review the progress of the Manual and provide invaluable technical and policy feedback to the production team:

Alan Neal  
Alfie Vick  
Andrew Walter  
Angela Bray  
Barbara Seal  
Ben Emanuel  
Bill Hodgins  
Brad McManus  
Christine McKay  
Connie Fish  
Cory Rayburn  
Dan Skalsky  
Danelle Alloway  
David Chastant  
David Hendrix  
Emily Davenport  
Frances Carpenter  
Glen Behrend  
Jackie Jackson  
Jason Bodwell  
Jeff Linzer  
Jeremy Diner  
Jian Fien  
Joy Hinkle  
Katherine Gurd  
Katherine Zitsch  
Kathy Macias

Mark Lawrence  
Michael Roberts  
Michael Williamson  
Mona Painter  
Patrick Winnubst  
Phil Hutchins  
Phil McCreanor  
Ron Feldner  
Stacy Funderburke  
Steve Leo  
Travis Burke  
Willie Jones

These individuals gave well over 1200 hours of in-kind services to provide review, comments, feedback, and content. Without this group, the revision of the Georgia Stormwater Management Manual would not have been possible.

Finally, thank you to all those throughout the state who took the time and effort to provide review comments and constructive suggestions on the draft versions of the Manual. These individuals represent an even larger segment of stakeholders beyond the TAG and include large and small cities, trade organizations, product manufacturers, federal agencies, and others.



[Click here for Volume 1: Local Government Guide](#)

[Click here for Volume 2: Technical Handbook](#)

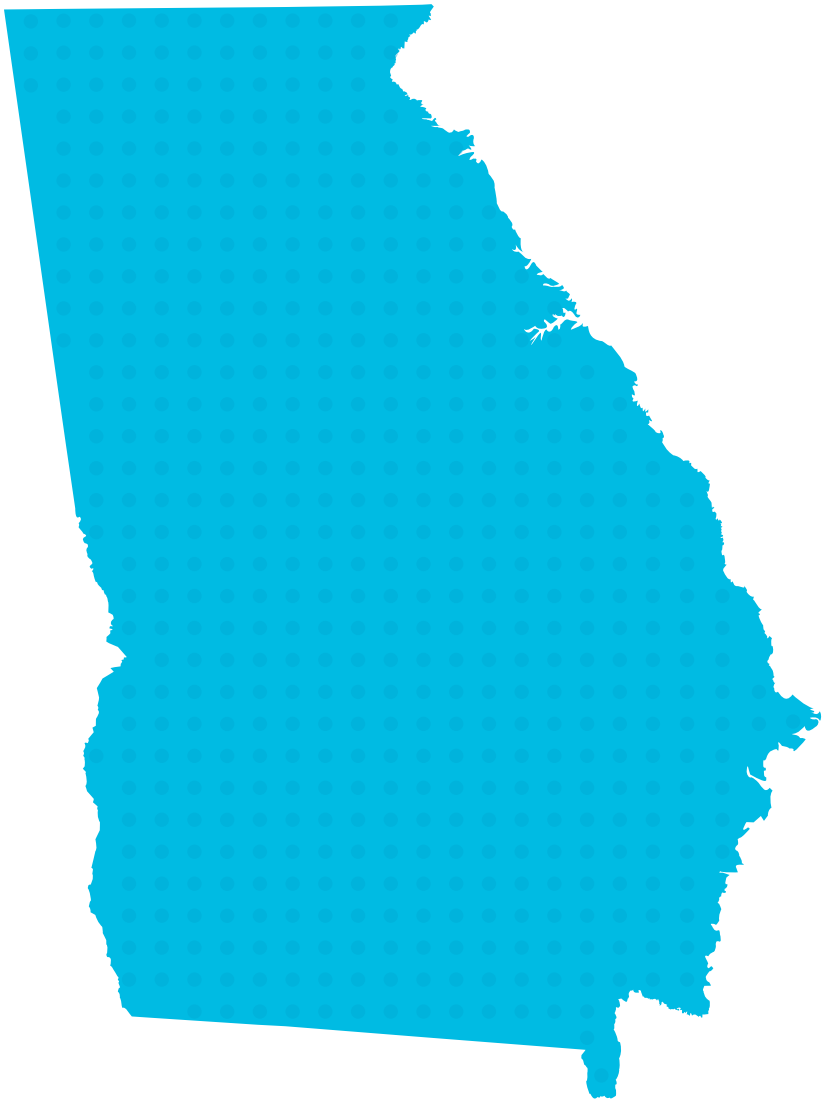

GEORGIA

STORMWATER MANAGEMENT MANUAL

2016 EDITION

**VOLUME 1: LOCAL GOVERNMENT GUIDE**

# Volume 1: Local Government Guide

Click on any of the items in the Table of Contents to go directly to that section.

<b>1. Introduction</b>	<b>1</b>
1.1 Objective of the Manual	1
1.2 Organization of the Manual	1
1.3 Users of This Volume	1
1.4 How to Use This Volume	2
1.5 Low Impact Development	2
1.6 Regulatory Status of the Manual	5
1.7 How to Find the Manual on the Internet	5
1.8 Contact Information	5
<b>2. Background on Post-Construction Stormwater Management</b>	<b>7</b>
2.1 Introduction to Stormwater Pollution	7
2.1.1 Impacts of Development Changes on Stormwater Runoff	8
2.1.2 Changes to Stream Flow	10
2.1.3 Changes to Stream Geometry	12
2.1.4 Impacts to Aquatic Habitat	13
2.1.5 Water Quality Impacts	14
2.1.6 Effects on Lakes, Reservoirs, and Estuaries	17
2.2 Stormwater Impacts on Georgia Communities	18
2.3 Benefits of Addressing Stormwater Impacts for Georgia Communities	23
2.4 Integrating Post-Construction Stormwater Management	25
2.5 National Pollutant Discharge Elimination System (NPDES) Municipal Separate Storm Sewer System (MS4) Program Requirements	29
2.5.1 MS4 Phase I Permits	30
2.5.2 MS4 Phase II Permits	31
2.6 Other Related Regulatory Requirements	34
2.6.1 Industrial NPDES Stormwater Permit Program	35
2.6.2 NPDES Stormwater Permits for Construction Areas	35
2.6.3 NPDES Municipal Wastewater Discharge Permit Program and Watershed Assessments	35
2.6.4 Erosion and Sedimentation Control Act	35
2.6.5 Total Maximum Daily Load (TMDL) Program	36
2.6.6 Georgia Planning Act	36
2.6.6.1 River Corridor Protection	36
2.6.6.2 Water Supply Watersheds	36
2.6.6.3 Groundwater Recharge Areas	37
2.6.7 Safe Drinking Water Act – Wellhead Protection Program	37
2.6.8 Source Water Assessment Program (SWAP)	37
2.6.9 Metropolitan River Protection Act (Atlanta metro area only)	38
2.6.10 Wetlands – Federal 404 Permits and the Georgia Planning Act	38
2.6.11 Coastal Management Program	38
2.6.12 Coastal Marshlands Protection Act	38
2.7 Unregulated Communities	39
<b>3. Better Site Design</b>	<b>41</b>
3.1 Introduction to Better Site Design	41
3.2 How to Make Your Local Development Codes Consistent with BSD Principles	44

3.3 Better Site Design Principles	52
3.3.1 Community Planning	54
3.3.1.1 Community Planning, Infill, and Redevelopment	54
3.3.2 Site Planning and Design	60
3.3.2.1 Natural Resources Inventory	61
3.3.2.2 Conservation of Natural Features	64
3.3.2.3 Development Design	68
3.3.2.4 Tree Conservation and Tree Canopy	72
3.3.2.5 Management of Open Space, Sustainable Landscaping	75
3.3.3 Reducing Impervious Cover and the Development Footprint	79
3.3.3.1 Reducing Roadway and Right-of-Way Width and Length	80
3.3.3.2 Alternative Roadway Components	86
3.3.3.3 Reducing Paved Parking and Walking Areas	92
3.3.3.4 Reducing Building Footprints	97
<b>4. Implementing Stormwater Management Requirements for Development</b>	<b>102</b>
4.1 Overview	102
4.2 Standards for Development	106
4.2.1 Introduction	107
4.2.2 Applicability	107
4.2.3 Stormwater Management Standards	109
4.3 Stormwater Management Site Plans	114
4.3.1 Introduction	115
4.3.2 Contents of a Stormwater Management Site Plan	115
4.3.3 Procedure for Reviewing Stormwater Site Plans	117
4.4 Different Development Types	121
4.4.1 Subdivision	122
4.4.2 Linear Projects	124
4.4.3 Redevelopment	125
4.4.4 Single Family Homes	126
4.4.5 Planned Unit Development	127
<b>5. Elements of Stormwater Management Programs</b>	<b>130</b>
5.1 Site Plan Review and Enforcement	130
5.1.1 Introduction	131
5.1.2 Roles of the Local Program, the Local Plan Reviewer, and the Design Engineer	131
5.1.3 Site Plan Review Process	133
5.1.4 Multidisciplinary Approach to Stormwater Management	135
5.1.5 Enforcement	136
5.2 Operation and Maintenance	138
5.2.1 Introduction	139
5.2.2 Low Impact Development Maintenance	140
5.2.3 Components of an Inspection and Maintenance Program	141
5.2.3.1 Stormwater System Level of Service	142
5.2.3.2 Inspections	142
5.2.3.3 Maintenance	143

5.2.4 Maintenance Program Responsibility	143
5.2.4.1 Assigning Inspection and Maintenance Responsibility	144
5.2.4.2 Communicating Program Responsibilities to the Public	145
5.2.4.3 Inspection and Maintenance Staff Resources	146
5.2.5 Legal Authority	146
5.2.5.1 Local Ordinance Provisions	146
5.2.5.2 Inspection and Maintenance Agreements	148
5.2.6 Inspection and Maintenance by Design	148
5.3 Geographic Information Systems (GIS)	152
5.3.1 Introduction	153
5.3.2 GIS Components	154
5.3.3 GIS Functions	154
5.3.4 Use of GIS in Stormwater Management	155
5.3.5 Other Related Technologies	156
5.4 Asset Management	157
5.4.1 Introduction	158
5.4.2 Stormwater Infrastructure Tracking System	158
5.4.3 Land Use and Land Cover Tracking	159
5.4.4 Reporting	160
5.5 Funding	161
5.5.1 Introduction	162
5.5.2 General Fund	162
5.5.3 Stormwater Utilities	162
5.5.4 Grant and Loan Programs	165
5.5.5 Other Funding Sources	166
5.5.5.1 General Obligations Bonds	166
5.5.5.2 Development Impact Fees	167
5.5.5.3 Special Assessments/Tax Districts	167
5.6 Adapting the Program to Meet Local Needs and Challenges	168
5.6.1 Introduction	169
5.6.2 Environmental Factors	169
5.6.3 Regional Factors	173
5.6.4 Past Growth Conditions and Patterns	176
5.6.5 Future Growth Conditions and Patterns	176
5.7 Watershed-Based Stormwater Planning	178
5.7.1 Introduction	179
5.7.2 Advantages and Disadvantages of Alternative Approaches	179
5.7.3 Off-Site Mitigation	180
5.7.4 Fee-In-Lieu	182
5.7.5 Offsets, Banking, and Trading	182
5.7.6 Conclusions	184
Appendix A: Contact Agencies for Stormwater Management Regulations and Programs	190
Appendix B: Stormwater Management Site Plan Review Checklists	195
Appendix C: Stormwater Construction Inspection Checklists	198
Appendix D: Example Stormwater Facility Maintenance Agreement	212

# 1. Introduction

## 1.1 Objective of the Manual

The objective of the Georgia Stormwater Management Manual is to provide guidance on the latest and best post-construction stormwater management practices available to Georgia communities to minimize the negative impacts of increasing stormwater runoff and its associated pollutants. Building on the previous version, this updated Manual will help Georgia communities take a comprehensive approach to stormwater management that integrates drainage design, stormwater quantity, and water quality considerations. The goal is to provide an effective tool for local governments and the development community to reduce both stormwater quality and quantity impacts and protect downstream areas and receiving waters.

Stormwater management has entered a new phase in the state of Georgia that recognizes the need for more innovative policies and practices. The requirements for NPDES municipal and industrial permits, TMDLs, watershed assessments and the desire to protect human life, property, aquatic habitats and the quality of life in our communities has brought home the pressing need to manage both stormwater quantity and quality from our developed and developing areas.

## 1.2 Organization of the Manual

The Georgia Stormwater Management Manual is organized as a three volume set, with each volume published as a separate document. You are currently reading Volume 1 of the Manual.

Volume 1 of the Manual, the *Local Government Guide to Stormwater Management*, is designed to provide guidance for local jurisdictions on the basic principles of effective urban stormwater management. Volume 1 covers the environmental, economic and social problems resulting from urban stormwater runoff and the need for local communities to address urban stormwater quantity and quality through recommended stormwater management standards and local stormwater programs. It also provides an overview of integrated stormwater management and technologies and tools for implementing stormwater management programs.

*Volume 2 of the Manual, the Technical Handbook*, provides guidance on the techniques and measures that can be implemented to meet a set of recommended stormwater management standards for new development and redevelopment. Volume 2 is designed to provide the site designer or engineer, as well as the local plan reviewer or inspector, with all of the information on best management practices (BMPs) required to effectively address and control both water quality and quantity on a development site. This includes guidance on site planning, better site design practices, hydrologic techniques, criteria for the selection and design of stormwater BMPs, and drainage system design, as well as construction and maintenance information.

Volume 3, the *Pollution Prevention Guidebook*, is a separate compendium of stormwater pollution

prevention practices for use by local jurisdictions, businesses and industry, and local citizens. Volume 3, the *Pollution Prevention Guidebook* can be found at the following website: [www.gastormwater.com](http://www.gastormwater.com)

## 1.3 Users of This Volume

Volume 1 of the Manual is primarily intended to provide guidance for local government officials and staff on implementing stormwater management programs. The audience for Volume 1 also includes public agencies, such as Regional Commissions, and other organizations concerned with land use, development, and stormwater runoff management.

Other interested parties and the general public may also find Volume 1 helpful because it describes how managing stormwater improves water quality and quantity, helps protect the State's valuable natural resources and contributes to other social and economic benefits. Traditional urban stormwater management had unintended negative environmental, economic, and social consequences, including deteriorating water quality, reduced stream base flows, unstable stream banks, lakes filling with sediment, and flooding. Adoption of new comprehensive management strategies using low impact development (LID) concepts will reduce these negative impacts of stormwater runoff. These LID concepts help reduce runoff from new and re-development sites by using BMPs that encourage infiltration, evapotranspiration, and or harvest and use of stormwater runoff onsite.

## 1.4 How to Use This Volume

The following provides a guide to the various chapters of Volume 1 of the Manual.

- **Chapter 1 – Introduction.** This chapter identifies the objective of the manual and the target audience, provides a brief overview of the rest of Volume 1, and introduces and defines the concept of LID. Much of the guidance in Volume 1 is intended to encourage the adoption of LID practices, as they can be very effective at addressing the negative stormwater impacts of development, impervious cover, and runoff.
- **Chapter 2 – Background on Post-Construction Stormwater Management.** This chapter begins with a discussion of the negative impacts of stormwater pollution, followed by explanations and summaries of the regulatory framework for local stormwater management in Georgia, including the state and federal laws, regulations, and programs, which are required of local communities in Georgia or may impact local stormwater management activities.
- **Chapter 3 – Better Site Design.** This chapter provides a detailed description of better site planning and design principles, discusses how those principles affect stormwater management, and provides guidance on how a local government can (and should) implement better site planning and design practices.
- **Chapter 4 – Instituting Local Stormwater Management Programs.** This chapter presents a set of recommended stormwater management standards for new development and redevelopment that communities can adopt as part of their local development code, and it identifies the components of a stormwater management plan. A range of development types, including subdivisions, linear projects, and redevelopment projects, are also discussed.
- **Chapter 5 – Elements of Stormwater Management Programs.** This chapter covers many of the key aspects of a local stormwater management program, including sections on site plan review and enforcement procedures and operation and maintenance requirements. In addition, Chapter 5 provides a toolbox to address development activities, which includes:
  - » Geographical Information Systems (GIS)
  - » Asset Management
  - » Funding
  - » Adapting the Program to Meet Local Needs and Challenges
  - » Watershed-Based Stormwater Planning
- **Appendix A – Contact Agencies for Stormwater Management Regulations and Programs.** This appendix includes contact information for the various regulatory and other programs covered in Chapter 2.
- **Appendix B – Stormwater Site Plan Review Checklists.** This appendix provides example checklists outlining the necessary steps to prepare preliminary and final stormwater management site plans.

- **Appendix C – Stormwater Construction Inspection Checklists.** This appendix includes construction forms for each type or group of best management practices (BMPs) included in Volume 2.
- **Appendix D – Example Stormwater Maintenance Agreement.** This appendix contains an example maintenance agreement for stormwater management facilities between a local government and a private party.

## 1.5 Low Impact Development

Much of the guidance in Volume 1 is focused on the concept of LID, and the idea that implementation of LID can help communities achieve social and economic goals while they improve water quality and quantity and protect their natural resources. Low Impact Development is an approach to land development or redevelopment that seeks to emulate the natural water cycle as much as possible and reduce the negative impacts of development and impervious cover. This is done by minimizing the production of runoff through the application of better site design techniques (see [Chapter 3](#)) that direct development to appropriate areas, preserve natural features that aid in water management, and minimize impervious cover. These better site design techniques are combined with BMPs (see [Volume 2, Chapter 4](#)) that manage stormwater at the source as much as possible through processes that include infiltration, evapotranspiration, rainwater harvesting, and extended filtration.

The terms Low Impact Development, or LID, and Green Infrastructure (GI) are often used interchangeably, as their meanings are very similar, especially when considered at the individual property or development level. However, the meaning of GI can vary depending on the site scale. According to the Environmental Protection Agency (EPA), “At the scale of a city or county, green infrastructure refers to the patchwork of natural areas that provides habitat, flood protection, cleaner air, and cleaner water. At the scale of a neighborhood or site, green infrastructure refers to stormwater management systems that mimic nature by soaking up and storing water” (US EPA). Given the variability in the meaning of “green infrastructure,” and this manual’s emphasis on the neighborhood and site scale, Low Impact Development and LID are used instead throughout this manual.

While this manual concentrates mainly on the neighborhood and site scale, application of regional or landscape-scale GI is an important complement, and is necessary to help communities reduce the serious and costly problems that can be created by traditional stormwater management practices. Regional and landscape-scale GI approaches to identify and conserve natural areas may include:

- Create a community-wide natural resources inventory that prioritizes conservation of forests, floodplains, stream buffers and wetlands in order to establish a community network of landscape scale green infrastructure to provide essential ecosystem services.

- Identify flood prone areas in the community and address them by acquiring floodplain properties, restricting development in these watersheds, or requiring runoff volume reduction or greater stormwater detention in those areas.
- Prepare comprehensive plans and zoning that allow the community to choose where and how densely development should (and should not) occur, or where redevelopment will be encouraged/incentivized.
- Establish legal mechanisms and incentives to encourage preferable types of development, for example, cluster developments, conservation subdivisions, city centers and conservation easements, which will allow more of the land area to be left in a natural state and reduce the stormwater impacts of the developed area.

See [Section 3.3.1](#) and [Section 3.3.2](#) for more information on community- and site-level conservation approaches.

### Key Principles for LID

Low Impact Development is more than an alternative set of stormwater BMPs. LID can best be achieved if viewed in the context of the larger design process. The Low Impact Development Manual for Michigan highlights the following principles and key components of an LID design approach:

- **Plan first.** To minimize stormwater impacts, stormwater management and LID should be integrated into the community planning and zoning process.

- **Prevent.** Then mitigate. A primary goal of LID is preventing stormwater runoff by incorporating nonstructural practices into the site development process. This can include preserving natural features, clustering development, and minimizing impervious surfaces. Once prevention as a design strategy is maximized, then the site design — using structural BMPs — can be prepared.
- **Minimize disturbance.** Limiting the disturbance of a site reduces the amount of stormwater runoff control needed to maintain the natural hydrology.
- **Manage stormwater as a resource — not a waste.** Approaching LID as part of a larger design process enables us to move away from the conventional concept of runoff as a disposal problem (and disposed of as rapidly as possible) to understanding that stormwater is a resource for groundwater recharge, stream base flow, lake and wetland health, water supply, and recreation.
- **Mimic the natural water cycle.** Stormwater management using LID includes mimicking the water cycle through careful control of peak rates as well as the volume of runoff and groundwater recharge, while protecting water quality. LID reflects an appreciation for management of both the largest storms, as well as the much more frequent, smaller storms.
- **Disconnect. Decentralize. Distribute.** An important element of LID is directing runoff to BMPs as close to the generation point as possible, in patterns that are decentralized and broadly distributed across the site.



- **Integrate natural systems.** LID includes careful inventorying and protection of a site's natural resources that can be integrated into the stormwater management design. The result is a natural system that not only provides water quality benefits, but greatly improves appearance and minimizes infrastructure.
- **Maximize the multiple benefits of LID.** LID provides numerous stormwater management benefits, but also contributes to other environmental, social, and economic benefits. In considering the extent of application of LID, communities should consider these other benefits.
- **Use LID everywhere.** LID can work on redevelopment, as well as new development, sites. In fact, LID can be used on sites that might not traditionally be considered for LID techniques, such as in combined sewer systems, along transportation corridors, and on brownfield sites. Broad application of LID techniques improves the likelihood that the desired outcome of water resource protection and restoration will be achieved.
- **Make maintenance a priority.** The best LID designs lose value without a commitment to maintenance. An important component of selecting a LID technique is understanding the maintenance needs and institutionalizing a maintenance program. Selection of optimal LID BMPs should be aligned with both the nature of the proposed land use/building program and the owners/operators of the site, for implementation of effective future maintenance activities.

### **Other Environmental, Economic, and Social Benefits of Implementing LID**

In addition to the significant stormwater and water quality benefits (reduced stormwater pollutant levels, improved aquatic biodiversity, increased stream base flows, groundwater recharge, reduced flooding, etc), implementation of LID strategies can provide many additional direct and indirect benefits for homeowners, developers, and communities.

#### **HOMEOWNERS**

- Preserved mature trees can shade homes, which can reduce air conditioning needs and energy costs.
- Directing stormwater runoff to vegetated areas and utilizing native plants reduces irrigation needs.
- Treating stormwater runoff close to its source with a distributed system may reduce nuisance flooding problems.

#### **DEVELOPERS**

- Preserving natural features and vegetation reduces the cost of land clearing and grading.
- Minimizing impervious cover reduces the cost of infrastructure (sidewalks, curbs, streets, etc.).
- As described in several of the studies highlighted below, incorporating LID into a site design can decrease overall stormwater management costs.
- Mature trees and other vegetative amenities can increase property values.

#### **COMMUNITIES**

- Reduced irrigation demands improve water supply reliability.

- Infiltrating LID BMPs contribute to groundwater recharge.
- Reduced impervious cover and increased evaporative cooling decreases the urban heat island effect.
- Runoff reduction decreases the magnitude and frequency of combined sewer overflow events.

### **Cost Effectiveness of LID**

Cost issues are among the main objections to implementing LID. However, many studies have shown that properly applied LID approaches and BMPs can be more cost effective than more conventional stormwater management approaches. The list below includes case studies, research, recommendations, and site specific costs for implementing LID:

- "Case Studies Analyzing the Economic Benefits of Low Impact Development and Green Infrastructure Programs" (US EPA, 2013) — This report seeks to educate stormwater professionals on the potential benefits of LID and Green Infrastructure (GI) programs using thirteen (13) case studies from a variety of communities around the country. [http://water.epa.gov/polwaste/green/upload/lid-gi-programs\\_report\\_8-6-13\\_combined.pdf](http://water.epa.gov/polwaste/green/upload/lid-gi-programs_report_8-6-13_combined.pdf)
- "Reducing Stormwater Costs through Low Impact Development (LID) Strategies and Practices" (US EPA, 2007) — This document summarizes seventeen (17) case studies comparing the costs of LID methods to the costs of conventional development methods. In many cases, the LID methods proved to be both less costly and more

environmentally beneficial than the traditional methods: [http://water.epa.gov/polwaste/green/costs07\\_index.cfm](http://water.epa.gov/polwaste/green/costs07_index.cfm)

- “The Economics of Low-Impact Development: A Literature Review (ECONorthwest, 2007) — This paper discusses the costs and benefits of LID practices as well as their proper application. <http://www.econw.com/our-work/publications/the-economics-of-low-impact-development-a-literature-review>
- “Low Impact Development Versus Conventional Development” (Shaver, 2009) — This report discusses LID practices applied in New Zealand and the USA. Nine (9) case studies were analyzed (3 in New Zealand and 6 in the USA) and LID costs were compared to conventional measures. In every case, LID was shown to be more cost effective than using conventional measures.
- “Forging the Link, Linking the Economic Benefits of Low Impact Development and Community Decisions” - Chapter 3 from the Economics of LID (UNH, 2011) — Chapter 3 of this document discusses the costs associated with LID practices and how incorporating LID/GI into a project can reduce the cost of stormwater management. <http://www.unh.edu/unhsc/recent-projects/forging-link-linking-economic-benefits-low-impact-development-and-community-decision>

## 1.6 Regulatory Status of the Manual

The Georgia Stormwater Management Manual is designed to provide Georgia communities with comprehensive guidance on a Low Impact Development (LID)-based approach to natural resource protection, stormwater management and site design that they can use to better protect the state’s valuable natural resources from the negative impacts of land development and nonpoint source pollution. Although communities may choose to use the information presented in this manual to regulate new development and redevelopment activities, the document itself has no independent regulatory authority. The approach to natural resource protection, stormwater management and site design detailed in the Georgia Stormwater Management Manual can only become required through:

- (1) Codes and ordinances established by local governments
- (2) Rules, regulations, and permits established by local, state and federal agencies

It is recommended that all Georgia communities use the information presented in this manual, or an equivalent post-construction stormwater management manual, to regulate new development and redevelopment activities. For those communities that are covered under the National

Pollutant Discharge Elimination System (NPDES) Municipal Stormwater Program, adoption of portions of this manual, specifically Volume 2 (or an equivalent), is required.

Communities are encouraged to review and modify the contents of this manual, as necessary, to meet local watershed and stormwater management goals and objectives while still maintaining the essence of a Low Impact Development (LID)-based approach for stormwater management.

## 1.7 How to Find the Manual on the Internet

All three volumes of the Georgia Stormwater Management Manual are also available in Adobe Acrobat PDF document format for download at the following Internet address:

<http://www.georgiastormwater.com>

## 1.8 Contact Information

If you have any technical questions or comments on the Manual, please send an email to:

[info@georgiastormwater.com](mailto:info@georgiastormwater.com)

## References

- ECONorthwest. 2007. *The Economist of Lost Impact Development: A Literature Review*. ECONorthwest, Portland, Oregon.
- Shaver, Earl. 2009. *Low Impact Design Versus Conventional Development: Literature Review of Developer-related Costs and Profit Margins*. Auckland Regional Council, Auckland New Zealand.
- Southeast Michigan Council of Governments. 2008. *Low Impact Development Manual for Michigan: A Design Guide for Implementors and Reviewers*. SEMCOG, Detroit, Michigan.
- University New Hampshire Stormwater Center. 2011. *Forging the Link: Linking the Economic Benefits of Low Impact Development and Community Decisions*. UNH Stormwater Center, Durham, New Hampshire.
- U.S. Environmental Protection Agency 2013. *Case Studies Analyzing the Economic Benefits of Low Impact Development and Green Infrastructure Programs*. U.S. Environmental Protection Agency, Washington D.C.
- U.S. Environmental Protection Agency 2007. *Reducing Stormwater Costs through Low Impact Development (LID) Strategies and Practices*. U.S. Environmental Protection Agency, Washington D.C.
- U.S. Environmental Protection Agency. "What is Green Infrastructure?". U.S. Environmental Protection Agency, Washington D.C.

## 2. Background on Post-Construction Stormwater Management

### 2.1 Introduction to Stormwater Pollution

**Description:** Development often has negative effects on both the quality and quantity of stormwater runoff. The additional impervious surfaces cause increases in peak flows and total runoff volume. Further, the additional runoff picks up greater concentrations of many pollutants, degrading water quality in receiving waters.



#### KEY CONSIDERATIONS

When not properly managed, the land development's negative impacts on stormwater runoff quantity and quality leads to:

- Increased Peak Flows and Decreased Base Flows in Streams
- Erosion and/or Sedimentation of Streams
- Loss of Riparian Trees
- Increased Floodplain Elevations
- Degraded Fish Habitat
- Increased Pollution from Nutrients, Hydrocarbons, Toxic Substances, Trash, etc.



The growth and development of Georgia's towns, cities, and suburbs have profoundly altered natural drainage systems and water resources in our state. Urbanization changes not only the physical, but also the chemical and biological, conditions of our waterways. This chapter describes the impacts of development and urban stormwater runoff.

### 2.1.1 Impacts of Development Changes on Stormwater Runoff

When land is developed, the hydrology, or the natural cycle of water is disrupted and altered. Streams and waterways are so sensitive to development that significant impacts to stream water quality become evident with as little as 10% impervious cover in a watershed. Land clearing removes vegetation that would otherwise intercept and slow runoff, allowing it to return to the air through evaporation and transpiration. Grading flattens hilly terrain and fills in natural depressions that slow and provide temporary storage for rainfall. The topsoil is scraped and removed, and the remaining subsoil is compacted. Rainfall that once seeped into the ground now runs off the surface. The addition of buildings, roadways, parking lots and other surfaces that are impervious to rainfall further reduces infiltration and increases runoff. Figure 2.1-1 is an example of the changes that take place as an area is developed.

This type of development is not limited to a few urban areas. Population growth has been increasing throughout much of Georgia, and development density has increased along with it. Figure 2.1-2 illustrates the significant increase in housing density from 1970 to 2000 and predictions for 2030.



Figure 2.1-1 Typical Changes in Land Surface for a Commercial Site  
(City of Roswell, Georgia – 1958 and 2015)



Depending on the magnitude of changes to the land surface, the total runoff volume can increase dramatically, as illustrated in Figure 2.1-3. Development can not only increase the total volume of runoff, but also accelerate the rate at which runoff flows across the land. This effect is further exacerbated by drainage systems such as gutters, storm sewers, and lined channels that are designed to quickly carry runoff to rivers and streams.

Development and impervious surfaces also reduce the amount of water that is infiltrated into the soil and groundwater, thus reducing the amount of water that can recharge aquifers and increase stream base flows.

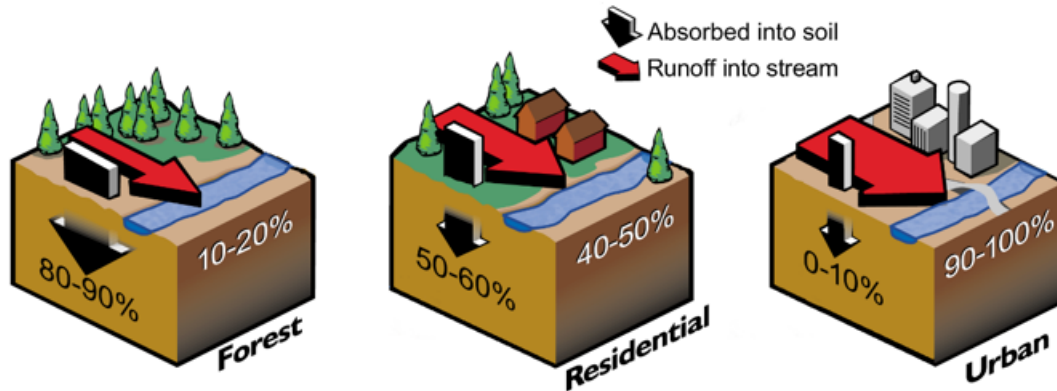
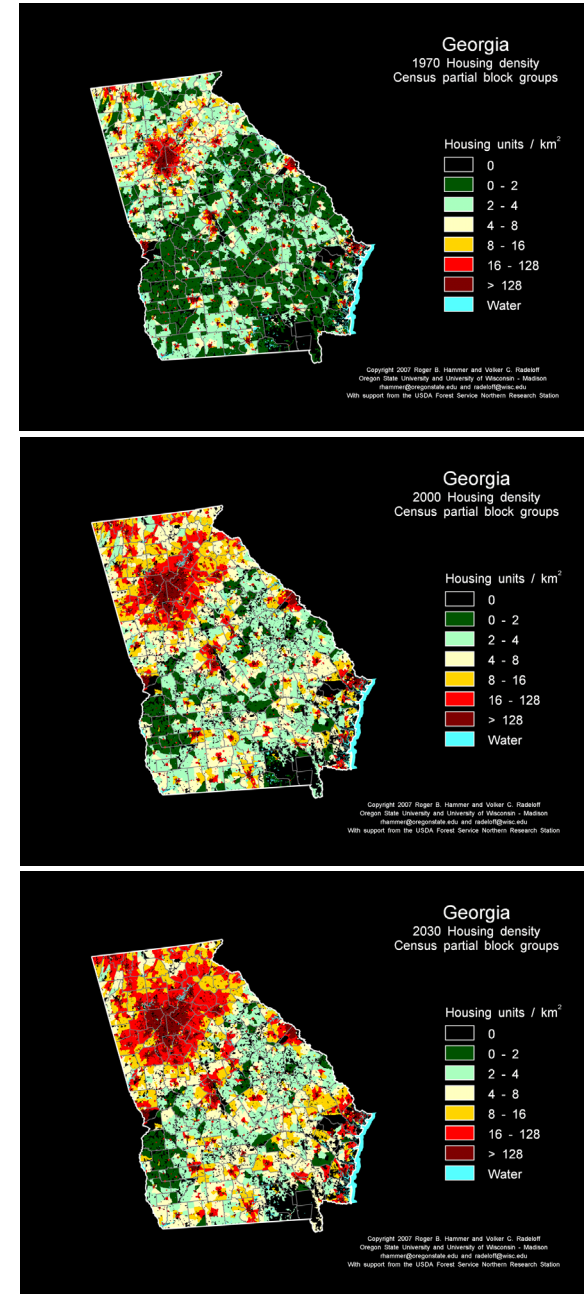

Figure 2.1-3 Changes in Hydrology and Runoff Due to Development Based on Marsh, 1983. Graphic courtesy of Atlanta Journal-Constitution

Figure 2.1-2 Changes in Housing Density in Georgia from 1970 – 2030 (Source: Radeloff, et al)



Finally, development and urbanization affect not only the quantity of stormwater runoff, but also its quality. Development increases the concentration and number of different pollutants carried by runoff. As it runs over rooftops, lawns, parking lots, and industrial sites, stormwater picks up and transports a variety of pollutants to downstream waterbodies. The loss of the original topsoil and vegetation removes a valuable filtering mechanism for stormwater runoff.

The cumulative impact of development and urban activities, and the resultant changes to stormwater quantity and quality in the land area that drains to a stream, river, lake or estuary determines the conditions of the waterbody. This land area that drains to the waterbody is known as its watershed. Urban development within a watershed has a direct impact on downstream waters. The impacts of development on watersheds can be placed into four interrelated categories, which are discussed over the next several pages:

- Changes to stream flow
- Changes to stream geometry
- Impacts to aquatic habitat
- Water quality impacts

### 2.1.2 Changes to Stream Flow

Urban development alters the hydrology of watersheds and streams by disrupting the natural water cycle, which typically results in:

- Increased Runoff Volumes – Land surface changes can dramatically increase the total volume of runoff generated in a developed watershed, as shown in Figure 2.1-4.
- Increased Peak Runoff Discharges – Increased peak discharges for a developed watershed can be two to five times higher than those for an undeveloped watershed.
- Greater Runoff Velocities – Impervious surfaces and compacted soils, as well as improvements to the drainage system, such as storm drains, pipes, and ditches, increase the speed at which rainfall runs off land surfaces within a watershed.
- Timing – As runoff velocities increase, it takes less time for water to run off the land and reach a stream or other waterbody.
- Increased Frequency of Bankfull and Near Bankfull Events – Increased runoff volumes and peak flows increase the frequency and duration of smaller bankfull and near bankfull events which are the primary channel forming events.
- Increased Flooding – Increased runoff volumes and peaks also increase the frequency, duration and severity of out-of-bank flooding as shown in Figure 2.1-5.
- Lower Base Flows (Dry Weather Flows) – Reduced infiltration of stormwater runoff causes streams to have less baseflow during dry weather periods and reduces the amount of rainfall recharging groundwater aquifers.

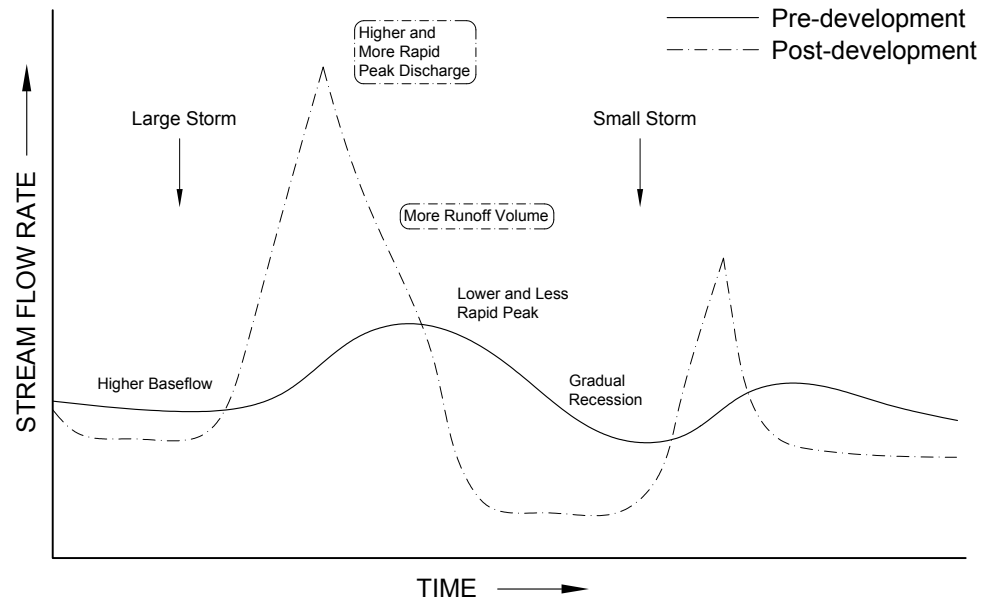

Figure 2.1-4 Impervious Cover Increases Stormwater Runoff and Pollutants

Streams in developed areas are often characterized as very “flashy” or “spiky” because of the increased volume of stormwater runoff, greater peak flows, and quicker hydrologic response to storms. This characterization translates into the sharp peak and increased size of the post-development hydrograph, as shown in Figure 2.1-6. This diagram shows the hydrograph for a typical 30-acre residential site during a 10-year storm event.



Figure 2.1-5 Increased Runoff Peaks and Volumes Increase Stream Flows and Flooding  
 (Right Photo Source: Augusta Chronicle / Photo by Cindy Blanchard)



Changes in stream hydrology as a result of urbanization (Schueler, 1992)

Figure 2.1-6 Hydrograph under Pre- and Post-Development Conditions  
 (Source: Schueler, 1992)



### 2.1.3 Changes to Stream Geometry

Changes in the rates and amounts of runoff generated from developed watersheds directly affect the morphology, or physical shape and character, of Georgia's streams and rivers. Some of the common impacts of urban development include:

- **Stream Widening and Bank Erosion** – Stream channels widen to accommodate and convey the increased runoff and higher stream flows from developed areas. More frequent small and moderate runoff events undercut and scour the lower parts of the stream bank, causing the steeper banks to erode and collapse during larger storms. Higher flow velocities further increase stream bank erosion rates. A stream can widen to many times its original size due to post-development runoff, as illustrated in Figure 2.1-7.
- **Stream Downcutting** – Another way that streams accommodate higher flows is by downcutting their streambed, as shown in Figure 2.1-8. This causes instability in the stream profile, or elevation along a stream's flow path, which increases velocity and triggers further channel erosion both upstream and downstream.
- **Loss of Riparian Tree Canopy** – As stream banks are gradually undercut and slump into the channel, trees that had protected the banks are exposed at the roots. This leaves trees less stable and more likely to be uprooted during major storms, which further weakens bank structure.

- **Changes in Channel Bed Due to Sedimentation** – Due to channel erosion and other sources upstream, sediments are deposited in the stream as sandbars and other features, covering the channel bed, or substrate, with shifting deposits of mud, silt, and sand.
- **Increase in Floodplain Elevation** – To accommodate the higher peak flow rate, a stream's floodplain elevation typically increases following development in a watershed. This problem is compounded by development in floodplains, which causes flood heights to rise even further. Property and structures that had not previously been subject to flooding may now be at risk.



Figure 2.1-7 Example of Stream Bank Erosion

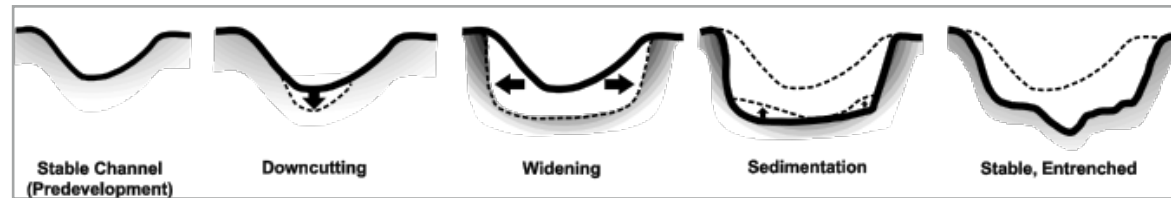

Figure 2.1-8 Changes to a Stream's Physical Character Due to Watershed Development

### 2.1.4 Impacts to Aquatic Habitat

Along with changes in stream hydrology and morphology, the habitat value of streams diminishes due to development in a watershed. Impacts on habitat include:

- Degradation of Habitat Structure – Higher and faster flows due to development can scour channels and wash away entire biological communities. Stream bank erosion and the loss of riparian vegetation reduce habitat for many fish species and other aquatic life, while sediment deposits can smother bottom-dwelling organisms and aquatic habitat.
- Loss of Pool-Riffle Structure – Streams draining undeveloped watersheds often contain pools of deeper, more slowly flowing water that alternate with “riffles” or shoals of shallower, faster flowing water. These pools and riffles provide valuable habitat for fish and aquatic insects. As a result of the increased flows and sediment loads from urban watersheds, these pools and riffles can disappear and be replaced with more uniform (and often shallower) streambeds that provide less varied aquatic habitats.
- Reduced Baseflows – Reduced baseflows due to increased impervious cover in a watershed and the loss of rainfall infiltration into the soil and water table adversely affect in-stream habitats, especially during periods of drought.
- Increased Stream Temperature – Runoff from warm impervious areas, storage in impoundments, loss of riparian vegetation,

and shallow channels can all cause an increase in temperature in urban streams. Increased temperatures can reduce DO levels and disrupt the food chain. Certain aquatic species can only survive within a narrow temperature range. Thermal problems are especially critical for many Piedmont streams, which straddle the borderline between cold water and warm water stream conditions.

- Decline in Wildlife Abundance and Biodiversity – When there is a reduction in various habitats and habitat quality, both the number and the variety, or diversity, of organisms (wetland plants, fish, macro invertebrates, etc.) are also reduced. Sensitive fish species and other life forms disappear and are replaced by those organisms that are better adapted to the poorer conditions. The diversity and composition of benthic (or streambed) habitats have frequently been used to evaluate the health of urban streams. Aquatic insects are also a useful environmental indicator as they are sensitive to changes in water quality.

Fish and other aquatic organisms are impacted by habitat changes brought on by increased storm-water runoff, as well as by water quality changes, due to development and resultant land use activities in a watershed. These impacts are discussed over the next several pages.



Figure 2.1-9 Impacts to Aquatic Habitat Can Eliminate Sensitive Fish Species and Other Aquatic Organisms

### 2.1.5 Water Quality Impacts

A water body is considered “impaired” when it fails to meet the water quality criteria associated with its designated uses. In Georgia, these uses may include: (1) fishing, (2) drinking water supply, (3) recreation, (4) coastal fishing, (5) wild river and (6) scenic river (GEPD d). Nonpoint source pollution, which is the primary cause of polluted stormwater runoff and water quality impairment, comes from scattered sources — many of which are associated with human activities within a watershed. Development concentrates and increases the amount of nonpoint source pollutants. As stormwater runoff moves across the land, it picks up and carries away both natural and human-made pollutants, depositing them into Georgia’s streams, rivers, lakes, wetlands, coastal waters and marshes, and underground aquifers. Nonpoint source pollution is the leading source of water quality degradation in Georgia, as shown in Figure 2.1-10.

Water quality degradation in urbanizing watersheds starts when development begins. Erosion from construction sites and other disturbed areas contributes large amounts of sediment to streams. As construction and development proceed, impervious surfaces replace the natural land cover, and pollutants from human activities begin to accumulate on these surfaces. During storm events, these pollutants are washed off into streams. Stormwater can also cause discharges

from sewer overflows and leaching from septic tanks. There are many other causes of nonpoint source pollution in urban areas, including leaking sewer pipes, sanitary sewage spills, and illicit discharges of wastewater and wash waters to storm drains. Table 2.1-1 provides a summary of major stormwater pollutants and their potential effects.

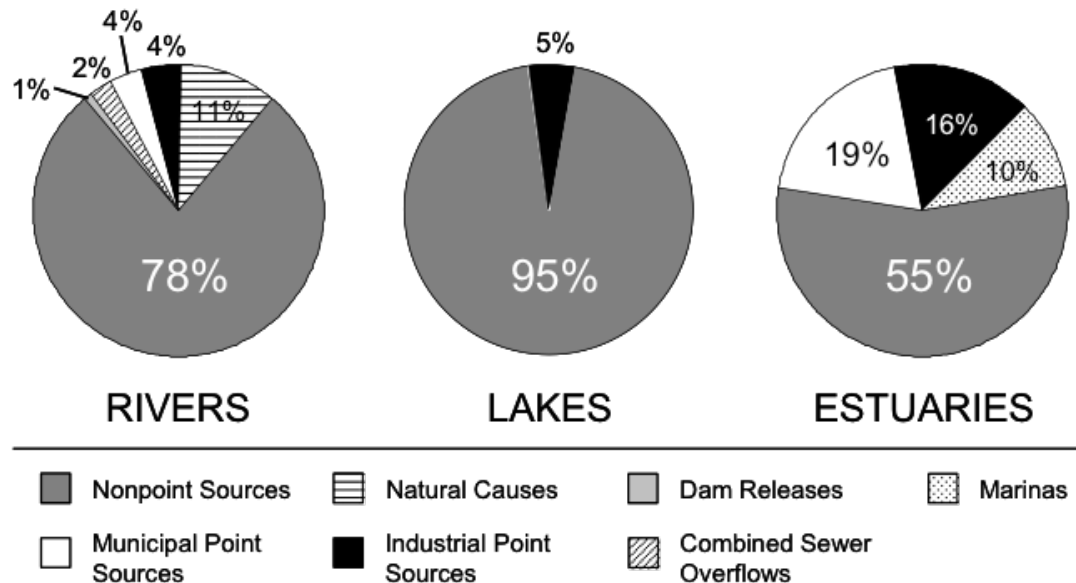

Figure 2.1-10 Causes of Water Quality Impairment in Georgia. In rivers, lakes, and estuaries, nonpoint sources (polluted stormwater runoff) are the major contributor to water quality impairments.

Source: State of Georgia 303(d) List of Impaired Waters, 2001

- Sediments – Eroded soils are a common component of urban stormwater and are a pollutant in their own right. Excessive sediment can be detrimental to aquatic life by interfering with photosynthesis, respiration, growth, and reproduction. Sediment particles transport other pollutants that are attached to their surfaces, such as nutrients, metals, and hydrocarbons. High turbidity due to sediment increases the cost of treating drinking water and reduces the value of surface waters for industrial and recreational uses. Sediment may also fill ditches, streams, storm sewers, and pipes, which can restrict flow and lead to flooding and property damage. Sedimentation can reduce the capacity of reservoirs and lakes, block navigation channels, and fill harbors and silt estuaries. Erosion from construction sites, exposed soils, street runoff, and stream bank erosion are the primary sources of sediment in urban runoff.

Constituents	Potential Effects
Sediments — Suspended Solids, Dissolved Solids, Turbidity	<ul style="list-style-type: none"> <li>• Stream turbidity</li> <li>• Habitat changes</li> <li>• Recreation and aesthetic losses</li> <li>• Contaminant transport</li> <li>• Filling of lakes and reservoirs</li> </ul>
Nutrients — Nitrogen and Phosphorus Compounds	<ul style="list-style-type: none"> <li>• Algae blooms</li> <li>• Eutrophication</li> <li>• Ammonia and nitrate toxicity</li> <li>• Recreation and aesthetic losses</li> </ul>
Pathogens — Total and Fecal Coliforms, Fecal Streptococci, Viruses, E. Coli, Enterococci	<ul style="list-style-type: none"> <li>• Ear and intestinal infections</li> <li>• Shellfish bed closure</li> <li>• Recreation and aesthetic losses</li> </ul>
Reduced Oxygen in Streams — Vegetation, Sewage, Other oxygen demanding substances	<ul style="list-style-type: none"> <li>• Dissolved oxygen depletion</li> <li>• Odors</li> <li>• Fish kills</li> </ul>
Hydrocarbons — Oil, Greases, Gasoline, Leaking vehicles, Improper disposal of motor oil	<ul style="list-style-type: none"> <li>• Danger to aquatic species</li> <li>• Recreational loss</li> <li>• Unsafe drinking water</li> </ul>
Toxic Materials — Heavy metals (cadmium, copper, iron, lead, magnesium, nickel, zinc), Organics, Pesticides/Herbicides	<ul style="list-style-type: none"> <li>• Human and aquatic toxicity</li> <li>• Bio-accumulation in the food chain</li> </ul>
Thermal Pollution — Changes in water temperature	<ul style="list-style-type: none"> <li>• Dissolved oxygen depletion</li> <li>• Habitat changes</li> <li>• Growth of harmful substances in water</li> <li>• Fish kills</li> </ul>
Trash and Debris — Floatables	<ul style="list-style-type: none"> <li>• Recreation and aesthetic losses</li> <li>• Human and aquatic toxicity</li> </ul>

Source: State of Georgia 303(d) List of Impaired Waters, 2001

- **Nutrients** – Runoff from urban and rural watersheds can contain increased nutrients, such as nitrogen or phosphorus compounds. Increased nutrient levels can be a problem as they promote weed and algae growth in lakes, streams, estuaries, and bays. Algae blooms can block sunlight from reaching underwater grasses, deplete oxygen when the organic matter decomposes (eutrophication), and cause public service water drinking systems to be contaminated. Further, nitrification of ammonia by microorganisms can consume dissolved oxygen (DO), while nitrates can contaminate water supplies. Sources of nutrients in the environment include fertilizers and vegetative litter; animal waste; sewer overflows and leaks from public, commercial, and residential systems; septic tank seepage; and detergents. Deposition from atmospheric nitrogen into surface waters is also an important source.
- **Pathogens** – Pathogens are harmful to human health and in natural waters may consist of bacteria, protozoa, viruses, and other microscopic organisms. The sources of pathogens in urban stormwater and streams may be leaking private or public sewer lines, combined sewer overflows, malfunctioning septic tanks, animals, pets, and birds. Agricultural runoff from livestock management areas, manure spreading, and concentrated animal feeding operations (CAFOs) can also contribute to pathogenic contamination. Pathogens can also contaminate shellfish beds, preventing their harvesting and human

consumption. Historically the fecal coliform group of bacteria has been used as indicator that pathogens may be present. However correlation between the presence of fecal coliforms and occurrence of illness is not strong; other pathogen indicators such as the e. coli group in freshwater and enterococci group in saltwater correlate better with human illness from swimming at bathing beaches.

- **Reduced Oxygen in Streams** – The decomposition process of organic matter uses up DO in the water, which is vital for fish and other aquatic life. As organic matter in the watershed is taken up by stormwater and conveyed to receiving waters, and as weed and algae growth occurs due to increased nutrient loading, DO levels can be rapidly depleted. If the DO deficit is severe enough, fish kills may occur and stream life can weaken and die. In addition, oxygen depletion can affect the release of toxic chemicals and nutrients from sediments deposited in a waterway. All forms of organic matter in urban stormwater runoff like leaves, grass clippings, and pet waste contribute to this problem. Additionally, there are non-stormwater discharges of organic matter to surface waters, such as sanitary sewer leakage and septic tanks leaching. While organic material is necessary for aquatic life, an overabundance of organic matter can contribute to these challenges.
- **Hydrocarbons** – Oils, greases, and gasoline contain a wide array of hydrocarbon compounds, some of which have been

shown to be carcinogenic, tumorigenic, and mutagenic in various species of fish and other lifeforms. In large quantities, oil can impact drinking water supplies and affect recreational use of waters. Oils and other hydrocarbons wash off roads and parking lots, primarily due to vehicle leaks. Other sources include improper disposal of motor oil in storm drains and streams, spills at fueling stations, and restaurant grease traps.

- **Toxic Materials** – Besides oils and greases, urban stormwater runoff can contain a wide variety of other toxicants and compounds, including heavy metals like lead, zinc, copper, and cadmium, as well as organic pollutants that include pesticides, PCBs, and phenols. These contaminants are of concern because they are toxic to aquatic organisms and can bio-accumulate in the food chain. They also impair drinking water sources and human health. Many toxicants accumulate in the sediments of streams and lakes. Sources of these contaminants include industrial and commercial sites, urban surfaces like rooftops and roadways, vehicles and other machinery, improperly disposed of household chemicals, landfills, hazardous waste sites, and atmospheric deposition.



- **Thermal Pollution** – As runoff flows over impervious surfaces, such as asphalt and concrete, it increases in temperature before reaching a stream or pond. Water temperatures are also increased due to shallow ponds and impoundments along a watercourse and fewer trees along streams to shade the water. Since warm water holds less DO than cold water, this “thermal pollution” further reduces oxygen levels in urban streams. Temperature changes can severely impact certain aquatic species, such as trout and stoneflies, which can survive only within a narrow temperature range.
- **Trash and Debris** – Considerable quantities of trash and other debris are washed through storm drain systems and into streams, lakes and bays, as shown in Figure 2.1-11. The presence of trash is an indicator of other anthropomorphic effects on water quality, stream structure, and aquatic habitat. The primary impacts are aesthetic “eyesores” in waterways, reduction in recreational value, and harm to aquatic life. Terrestrial and aquatic animals can be harmed when they consume or become entangled/engulfed in solid waste. Debris can also cause blockages of the stream channels and stormwater infrastructure, which can result in localized flooding and erosion. Stormwater infrastructure is directly affected by trash and debris-caused blockages resulting in reduction in capacity; increased maintenance is thus needed to restore to proper condition.

### 2.1.6 Effects on Lakes, Reservoirs, and Estuaries

Stormwater runoff into lakes and reservoirs can have some unique negative effects. A notable impact of urban runoff is the filling in of waterbodies with sediment. Another significant water quality impact on lakes related to stormwater runoff is nutrient enrichment, which can result in the undesirable growth of algae and aquatic plants. Lakes do not flush contaminants out as quickly as streams, so they act as sinks for nutrients, metals and sediments. This means that lakes can take longer to recover if contaminated.

Stormwater runoff can also impact estuaries, especially if runoff events occur in pulses, disrupting the natural salinity of an area and providing large loads of sediment, nutrients, and oxygen-demanding materials. These rapid pulses or influxes of fresh water into the watershed may be two to ten times greater than normal and may lead to a decrease in the number of aquatic organisms living in the unique estuarine environment. Tidal flow patterns can also effectively trap and concentrate runoff pollutants.



Figure 2.1-11 Trash and Debris Impact the Visual and Recreational Value of Waterbodies

## 2.2 Stormwater Impacts on Georgia Communities

**Description:** Stormwater runoff can have significant impacts on the health of our water resources; this can be due to changes in both water quality and water quantity. Yet stormwater runoff does not only lead to environmental issues. Improperly managed stormwater runoff often has physical and economic impacts on communities in Georgia and downstream.

### KEY CONSIDERATIONS

Improperly managed stormwater can create many negative impacts on a community, including:

- Increased Flooding
- Endangerment of Human Life from Floodwaters
- Property and Structural Damage Due to Flooding
- Impairment of Drinking Water Supplies (Surface and Groundwater)
- Increased Cost of Treating Drinking Water
- Loss of Recreational Opportunities
- Declining Property Values of Waterfront Homes and Businesses
- Loss of Sport and Commercial Fisheries
- Closure of Shellfish Harvesting Areas
- Reduced Drought Resiliency
- Increased Litigation
- Reduction in Quality of Life



As discussed in [Section 2.1](#), stormwater runoff can have significant impacts on the health of our water resources, due to changes in both water quantity and water quality. Yet stormwater runoff does not only lead to environmental issues. Improperly managed stormwater runoff often has real physical and economic impacts on communities in Georgia. For example:

- **Increased Flooding** – The increased stormwater runoff rates and volumes resulting from the land development process also cause an increase in the frequency, duration and severity of overbank and extreme flooding events (Figure 2.2-1). In other words, as more development occurs without proper stormwater management, our natural and man-made infrastructure becomes more vulnerable to flooding.
- **Endangerment of Human Life from Floodwaters** – A primary concern of many local governments is that of public safety. Development changes the hydrology of a watershed such that increased runoff peak flows and volumes can potentially overwhelm under-designed stormwater drainage facilities, structural controls, and downstream conveyances, putting human life at risk. Floodwaters can cause driving hazards by overtopping roadways and washing out bridges, as well as by carrying sediment and debris onto streets and highways.

- **Property and Structural Damage Due to Flooding** – Due to upstream development, properties that were previously outside the 100-year floodplain may now find themselves subject to flood damage. Areas that previously flooded only once every 10 years may now flood far more frequently and with more severity. Increased property and infrastructure damage can also result from stream channel widening, undersized runoff storage and conveyance facilities, and development in the floodplain.
- **Impairment of Drinking Water Supplies (Surface and Groundwater)** – Water quality degradation from polluted stormwater runoff can contaminate surface and groundwater drinking water supplies, making them potentially unfit for community use.
- **Increased Cost of Treating Drinking Water** – Even if a drinking water supply remains viable, heavy concentrations of contaminants, such as sediment and bacteria, can increase the cost of water treatment.



Figure 2.2-1 Flooding and Pollution from Stormwater Runoff



Figure 2.2-2 Flooding Endangers Human Life and Property  
(Left Photo Source: Augusta Chronicle / Photo by Jeff Janowski)



- Loss of Recreational Opportunities – Turbidity from sediment, trash, toxic pollutants, and microbial contamination in stormwater runoff all reduce the viability of receiving waterbodies for recreational activities, such as swimming, boating and fishing. Additionally, aesthetic losses along these waterways also reduce the experience for many noncontact recreational activities, including picnicking, jogging, biking, camping, and hunting.
- Declining Property Values of Waterfront Homes and Businesses – Stormwater pollution affects the appearance and quality of downstream waterbodies, influencing the desirability of working, living, traveling, or owning property near the water.
- Loss of Sport and Commercial Fisheries – Commercial fisheries are a significant part of Georgia's economy, generating over \$20 million annually. Only 22% of all Georgia lakes are safe for fish consumption. A significant part of the problem is attributable to polluted stormwater runoff.
- Closure of Shellfish Harvesting Areas – Only 35% of Georgia's estuaries are safe for shellfish consumption. Again, a major source of impairment is stormwater runoff.



Figure 2.2-3 Water Quality Problems Due to Runoff Impact Drinking Water Supplies and Recreational Use of Streams, Rivers, Lakes, and Beaches



Figure 2.2-4 Waterfronts are an Important Resource to Georgia Communities that Should Be Protected from the Effects of Polluted Stormwater

(Columbus Riverwalk (left) and Savannah Waterfront (right). Photos by Ed Jackson)

- Reduced Drought Resiliency – Increased stormwater runoff volumes resulting from land development reduces the amount of rainfall available to recharge shallow groundwater aquifers and feed freshwater rivers and streams during dry weather. Thus, streams have lower base flow, and are less able to withstand extended periods of drought.
- Increased Litigation – Legal action can be brought against local governments that have not adequately addressed stormwater runoff drainage and water quality problems.
- Reduction in Quality of Life – Stormwater quantity and quality impacts can reduce the quality of life in a community, making it a less desirable place to live, work, and play.



Figure 2.2-5 Polluted Stormwater Runoff Impacts Sport and Commercial Fisheries and Shellfish Harvesting



## CASE STUDY

### Impacts of Development on the Chattahoochee River National Recreation Area

In 1978, the Atlanta region benefited from the acquisition by the United States Department of Interior, National Park Service of 48-miles of Chattahoochee River buffer and open space for the creation of the Chattahoochee River National Recreation Area (CRNRA). Crossing four counties, nine municipalities, and three congressional districts, it is located in the North Georgia Metropolitan Planning District. The CRNRA's 6,700 acres is an excellent example of the community benefits that result when land is purchased to conserve nature. Treasured by local residents and visitors to Georgia alike, the CRNRA land and water resources are worthy of protection.

However, the CRNRA, like many of Georgia's water resources, has seen significant impacts from development. Water quality data provided by the State of Georgia for the Upper Chattahoochee watershed shows that the watershed is not meeting Georgia's water quality standards for many pollutants. Watersheds along the Chattahoochee are polluted for bacteria and sediment with reduced biodiversity in fish and macro-invertebrates. In addition, Georgia's water quality standards are not being met for other pollutants, including lead, PCBs in fish tissue, tetrachloroethylene, chlorophyll-A (nutrients), copper, and zinc. The probable sources contributing to the pollution are listed as primarily non-point source and unspecified urban stormwater. Data and information about Georgia streams and rivers can be found in the United States Environmental

Protection Agency's ATTAINS database at [http://iaspub.epa.gov/tmdl\\_waters10/attains\\_state\\_control?p\\_state=GA](http://iaspub.epa.gov/tmdl_waters10/attains_state_control?p_state=GA).

Often, the most visible sign of an impaired river system can be seen on the banks itself. Stream bank erosion caused by high volumes and rates of stormwater runoff is a common site in developed watersheds.

Improving water quality along the Chattahoochee and protecting the CRNRA will require action by all local governments with contributing watersheds. Application of LID at the site scale – conserving natural landscapes, reducing impervious cover, and implementing sound best management practices – through the principles put forth in the Georgia Stormwater Management Manual is one of several important steps in achieving this goal. However, application of LID and green infrastructure at the regional and neighborhood scale will be essential as well. Identification and preservation of natural resources and open spaces that naturally retain and cleanse stormwater should be undertaken at the regional scale, while construction of water quality and quantity retrofits, such as stormwater wetlands and bioretention should be done at the neighborhood scale, in key locations where they can be most beneficial for both communities and the CRNRA. With these efforts, the National Park Service should be better able to meet its mission, to leave the Chattahoochee River National Recreation Area "unimpaired for the enjoyment of future generations."



Figure 2.2-6 Crooked Creek, Norcross, GA: Creek Entrenchment and Stream Bank Instability  
(Photo: Bob Howard, 8/27/15)



Figure 2.2-7 Chatahoochee River bank erosion caused by fallen tree undermined by scouring in high flows  
Photo: CRNRA, National Park Service, 9/5/15)



## 2.3 Benefits of Addressing Stormwater Impacts for Georgia Communities

**Description:** Stormwater management can have many positive impacts beyond improvements to water quantity and water quality management.

### KEY CONSIDERATIONS

The following benefits of stormwater management are discussed in this section:

#### Community Development

- Public Health
- Beautification
- Public Space

#### Water Quantity

- Disaster Preparedness, Resiliency, and Flood Control
- Combined Sewer Overflow (CSO) Reductions
- Community Rating System (CRS) Credits

#### Water Quality

- Resiliency of Water Supply / Source Water Protection
- Healthy Receiving Waters
- Public Health
- Recreation

#### Regulatory Benefits

- Municipal Separate Storm Sewer Systems (MS4s)
- Total Maximum Daily Loads (TMDLs)
- Off-Site Compliance



Section 2.2 discusses the many negative impacts that can be caused by development and insufficient, improper, or non-existent stormwater management. Proper stormwater management and the implementation of sound stormwater management practices, especially LID, can eliminate or alleviate many of those impacts. In addition, there are many other benefits that can be realized by Georgia communities when a proactive approach to stormwater management and the implementation of LID practices is taken. Communities should consider these benefits along with their stormwater management goals when selecting a stormwater management approach.

### COMMUNITY DEVELOPMENT BENEFITS

- Public Health – Provision of greenspace and pedestrian connectivity allows for more opportunities to recreate and exercise, which can encourage community members to be more physically active. Improved access to nature also contributes to improved overall health and wellness.
- Beautification – Installation of LID and green infrastructure creates additional greenspace in communities, which can improve the aesthetic qualities of urban areas.
- Public Space – Stormwater facilities can be designed to incorporate community gathering spaces. Smart design of stormwater facilities allows them to provide multiple benefits.
- Community Rating System (CRS) Credits – The Federal Emergency Management Agency (FEMA) offers reductions in flood insurance premiums for private property owners in

communities that have earned credit for flood resiliency activities, including stormwater projects. Through the CRS, these premium reductions can be up to 45%. See Section 5.5.3.

### WATER QUANTITY BENEFITS

- Disaster Preparedness, Resiliency, and Flood Control – Communities that plan and implement projects to meet their stormwater management needs are generally better able to convey stormwater runoff from flood events to detention facilities or receiving water bodies, and away from sensitive properties and infrastructure.
- Combined Sewer Overflow (CSO) Reductions – Implementation of sound stormwater management practices, especially low impact development (LID) practices within CSO areas, can lead to a reduction in overflow events. Many communities have found that implementing LID stormwater management practices is a more cost effective technique to address CSOs than constructing large storage facilities or sewer separation projects.
- Waterway Resiliency – Utilization of Better Site Design and LID stormwater management practices that reduce runoff and increase infiltration can reduce the intensity of flooding events while at the same time increasing base flows between storm events, leading to healthier, more resilient waterways.

### WATER QUALITY BENEFITS

- Resiliency of Water Supply / Source Water Protection – Conservation of land, open space, and forest resources reduces the threat of contaminants being introduced to drinking water supplies.

- Healthy Receiving Waters – Effective stormwater management practices will lead to reduced erosion and sedimentation in our waterways, as well as a reduction in nutrient loads that contribute to algae blooms and fish kills.
- Public Health – Preserving water quality and reducing pollution, through implementation of stormwater projects and best practices, allow for safe recreation in receiving waters.
- Recreation – Rivers, lakes, streams, and oceans have long been major destinations for recreation and enjoyment for many of Georgia's residents and visitors. Removal of debris and prevention of contamination improves recreational experiences for all water-goers.

### REGULATORY BENEFITS

- Municipal Separate Storm Sewer Systems (MS4s) – Stormwater management and the implementation of best practices help municipalities comply with their MS4 permit.
- Total Maximum Daily Loads (TMDLs) – Completion of stormwater projects leads to nutrient and other pollutant reductions, which is vital to the implementation of TMDL plans that have been developed for certain impaired waters.
- Off-site Compliance – Regional facilities can create economies of scale that reduce the financial resources and land required to manage stormwater in a community. See Section 5.7 for more information on off-site compliance.



Figure 2.3-1 Sewer Overflow in the Chatahoochee River National Recreation Area  
(Photo: National Parks Service)

## 2.4 Integrating Post-Construction Stormwater Management

**Description:** Post-Construction Stormwater Management is only one of several important ways to address the effects of stormwater runoff. Additional programs and approaches are needed to achieve a comprehensive watershed and stormwater management program.



### KEY CONSIDERATIONS

The following six areas should be addressed at a minimum, which form the “umbrella” of comprehensive watershed and stormwater management:

- Watershed Planning
- Development Requirements
- Erosion and Sediment Control
- Floodplain Management
- Operations and Maintenance
- Pollution Prevention

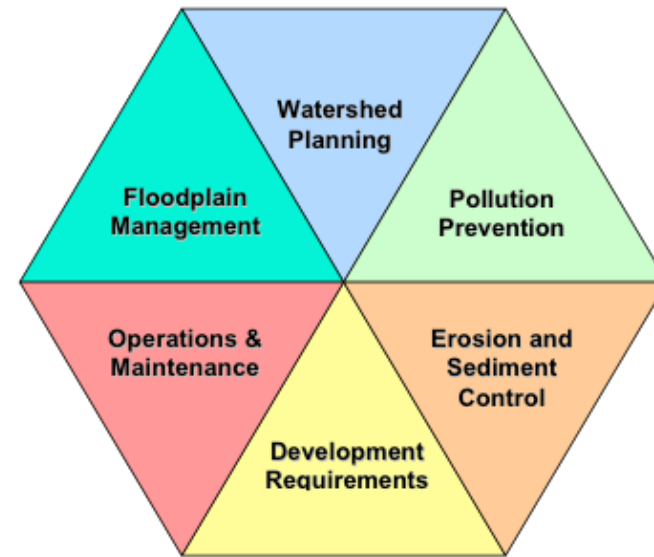

For a number of reasons — including public health and safety, environmental and economic concerns, legal liability, regulatory responsibility, and to improve quality of life — cities and counties across Georgia must manage development and stormwater runoff in their communities.

The focus of this Manual is how to effectively deal with the impacts of urban stormwater runoff through effective post-construction stormwater management at the site scale. However, site-scale post-construction stormwater management is only one aspect of a comprehensive watershed and stormwater program. Comprehensive watershed and stormwater management involves both the prevention and mitigation of stormwater runoff quantity and quality impacts through a variety of methods and mechanisms. Addressing watershed and stormwater management, and more specifically, green infrastructure at the landscape scale and neighborhood scale can provide significant benefits that cannot be achieved with site-scale efforts alone. By looking at stormwater management at various scales, stormwater managers can influence the impacts of development in a number of ways. For example, land use planning and zoning can be used to direct growth away from sensitive aquatic and terrestrial resources; land acquisition can be used to conserve valuable natural resources; and better site design techniques can be used to minimize land disturbance on development sites. Comprehensive stormwater management requires stormwater managers to be active in helping a community craft policies that achieve the goal of preserving natural resources. In this way, engaging

in growth and development discussions can be considered the “first stormwater best management practice.” For a detailed discussion of how stormwater management intersects with broader growth and development decisions, see Chapter 3, Land Use Planning as the First BMP in the manual *Managing Stormwater in Your Community, A Guide for Building an Effective Post-Construction Program*.

In general, comprehensive watershed and stormwater management can be broken down into the following six areas:

- **Watershed Planning** – Using the watershed as the framework for managing land use and developing large-scale solutions to regional stormwater quantity and quality issues. The Environmental Protection Agency (EPA)’s [Handbook for Developing Watershed Plans to Restore and Protect Our Waters](#), and the Center for Watershed Protection (CWP)’s [An Integrated Framework to Restore Small Urban Watersheds](#) are both useful watershed planning resources.

Stormwater master planning and watershed planning help to establish the priorities for stormwater management decision-making and should be incorporated early into an effective local program. Watershed planning is a tool which allows a community to assess current and future stormwater problems as well as potential solutions within a drainage basin. It can be used to assess the health of existing water resources and make informed land use, transportation, greenspace and other community-level decisions based upon current and projected land use and development within

a watershed and its associated subwatersheds. Watershed plans assist communities in developing and evaluating stormwater management scenarios and alternatives.

Watershed and stormwater master plans can be used to identify drainage system and stream segments in need of channel improvement or restoration, and potential locations for regional stormwater control facilities. Watershed planning can also provide a community with the necessary information for conserving natural areas and open space as well as the development of riparian buffers and greenways. In addition, they may also promote a wide range of additional goals including water supply protection, wetland protection and preservation, streambank and stream corridor restoration, habitat protection, protection of historical and cultural resources, enhancement of recreational opportunities, and aesthetic and quality of life issues.

In addition to providing better opportunities for managing stormwater problems and watershed resources, the watershed planning approach also involves stakeholders and provides community consensus in the land use and stormwater management decision-making process. Further, watershed plans promise a reduction in the overall capital and operation and maintenance costs for stormwater management from reduced downstream flooding and optimal siting and sizing of stormwater control measures. Other benefits include contributions to community land use plans, and increased equity and opportunities for developers.

- **Development Requirements** – Addressing the stormwater impacts of new development and redevelopment through stormwater management requirements and minimum standards. Development requirements are discussed in [Chapter 4](#) and [Section 5.1](#), with detailed specifications in [Volume 2, Chapter 4](#).

Volume 2 of this Manual is a comprehensive technical document for stormwater management which can be adopted by a community as its primary design aid for developers. Volume 2 is designed to support the recommended stormwater management standards and includes information and criteria on stormwater site plan preparation, recommended hydrologic methods, structural stormwater control selection and design, drainage system design, and inspection and maintenance provisions. A community may wish to prepare an addendum to Volume 2 which includes any specific local criteria and/or additional material. Additional design aids may be necessary depending on a local community's requirements.

- **Erosion and Sediment Control** – Controlling erosion and soil loss from construction areas and resultant downstream sedimentation. For more information on Erosion and Sediment Control, see the *Manual for Erosion and Sediment Control in Georgia*.

Sediment loadings to receiving waters are highest during the construction phase of development. Consequently, erosion and sediment control on construction sites is an important element

of a comprehensive stormwater management program for water quality and habitat protection. A combination of clearing restrictions, erosion prevention, and sediment controls, coupled with a diligent plan review and strict construction enforcement are needed to help mitigate these impacts.

It is essential that erosion and sediment control be considered in stormwater concept plans and implemented throughout the construction phase to prevent damage to natural stormwater drainage systems and post-construction structural stormwater controls and conveyance facilities.

- **Floodplain Management** – Preserving the function of floodplain areas to reduce flood hazards, minimize risks to human life and property, reduce modifications to streams, and protect water quality. For further information on Floodplain Management, see the Floodplain Management in Georgia Quick Guide, prepared by the Georgia Department of Natural Resources. [http://www.floods.org/PDF/QuickGuide/GAQQ2009\\_ScreenView.pdf](http://www.floods.org/PDF/QuickGuide/GAQQ2009_ScreenView.pdf)

Floodplain management involves the designation of flood-prone areas and the limiting of their uses to those compatible with a given degree of risk. It is also aimed at minimizing modifications to streams, reducing flood hazards and protecting the water quality of streams. As such, floodplain management can be seen as a subset of the larger consideration of surface water and stormwater management within a local community.

Though it is often considered separately in most communities, there are many areas in which floodplain management directly overlaps with other areas of stormwater management. The development of riparian buffers and greenway corridors along streams and rivers can also preserve floodplain areas and protect their function in safely conveying floodwaters. Floodplain regulations and development restrictions, particularly when based upon the full build-out 100-year floodplain, can greatly reduce future flooding impacts and may allow communities to waive stormwater quantity control (detention) requirements for larger storm events in some areas.

Ideally, flooding and floodplains should be managed at the watershed level, and floodplain management should be an important goal of comprehensive watershed plans. Consequently, floodplain management activities should be fully integrated into comprehensive stormwater management programs and handled in a complementary and coordinated approach.

- **Operations and Maintenance** – Ensuring that stormwater management systems and structural controls work as designed and constructed. Operation and maintenance activities are discussed in [Section 5.2](#), with recommendations for individual best management practices (BMPs) included in [Volume 2 Appendix E](#).

Ongoing operation and maintenance of the various components of a stormwater system is an essential component of a comprehensive



stormwater management program. Failure to provide effective maintenance can reduce the hydraulic capacity and the pollutant removal efficiency of stormwater controls and conveyance systems.

Operations and maintenance activities can include cleaning and maintenance of catch basins, drainage swales, open channels, storm sewer pipes, stormwater ponds, and water quality BMPs. Street sweeping and other pollution reduction activities also fall under operations and maintenance. Ideally, the best program addresses operations and maintenance concerns proactively instead of reacting to problems that occur such as flooding or water quality degradation.

A clear assignment of stormwater inspection and maintenance responsibilities, whether they be accomplished by the local government, land owners, private concerns, or a combination of these, is essential to ensuring that stormwater management systems function as they were intended. Maintenance requirements are an important consideration in the selection and design of structural stormwater controls and therefore site designs should strive to make their systems as simple and maintenance free as possible.

Stormwater system operations and maintenance can also include the retrofitting of existing development to meet water quantity and/or water quality goals.

- **Pollution Prevention** – Preventing stormwater from coming into contact with contaminants and becoming polluted through a number of management measures. This is discussed further in the *Georgia Stormwater Management Manual, Volume 3: Pollution Prevention Guidebook*, available at [www.gastormwater.com](http://www.gastormwater.com)

Also known as “source controls,” pollution prevention management practices are an important way to prevent water quality problems in stormwater runoff from a variety of sources. The intent of source control practices is to prevent stormwater from coming in contact with pollutants in the first place rather than providing structural controls for treatment and pollutant removal. Pollution prevention include categories of measures such as:

- » Materials management (use, exposure, and disposal/recycling controls)
- » Spill prevention and cleanup
- » Removal of illicit connections
- » Prevention of illegal dumping
- » Street and storm drain maintenance
- » Public information and education

Examples of source control practices include covering piles of soil to prevent erosion, safe hazardous waste storage, dry weather screening of stormwater outfalls to detect illicit connections, storm drain stenciling, street sweeping, fertilizer use restrictions, leaf collection programs, and efforts to educate and influence citizen’s actions (such as proper

motor oil disposal and household hazardous waste management) that impact stormwater runoff quality.

Many of these practices are easily implemented and are cost-effective means of reducing stormwater contaminants. As such, they should be considered, where appropriate, for all residential, commercial, industrial, institutional, and municipal projects and activities. In addition, many are required activities for NPDES municipal stormwater management programs.

Together these six categories create the “umbrella” of comprehensive watershed and stormwater management, shown in Figure 2.4-1.

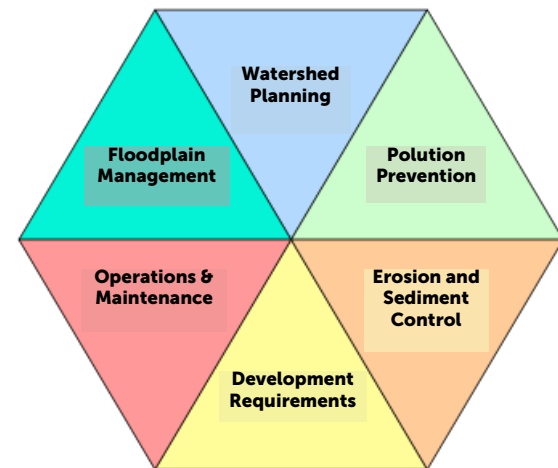

Figure 2.4-1 The “Umbrella” of Comprehensive Stormwater Management

## 2.5 National Pollutant Discharge Elimination System (NPDES) Municipal Separate Storm Sewer System (MS4) Program Requirements

**Description:** The National Pollutant Discharge Elimination System (NPDES) was established by the Clean Water Act in 1972 to address discharges containing pollutants from point and non-point sources. Municipal Separate Storm Sewer System (MS4) permitting requirements were established under the NPDES program beginning in 1987, requiring certain municipalities to minimize pollutants in stormwater runoff to the maximum extent practicable (MEP). Under Georgia EPD's MS4 permit program, communities in regulated areas are required to establish a comprehensive stormwater management program (SWMP) to address stormwater issues.



### KEY CONSIDERATIONS

Many of the urban water bodies in Georgia are impaired, and untreated stormwater runoff is typically a major cause of those impairments. The NPDES MS4 program represents an effort to regulate stormwater runoff and return these water bodies to conditions that support their designated uses. There are two types of MS4 permits. Phase I communities are medium and large cities and certain counties with populations of 100,000 or more. Phase II communities are smaller communities in urbanized areas, as determined by the U.S. Census Bureau. Both Phase I and Phase II MS4 communities must meet certain requirements to improve the water quality of stormwater runoff.

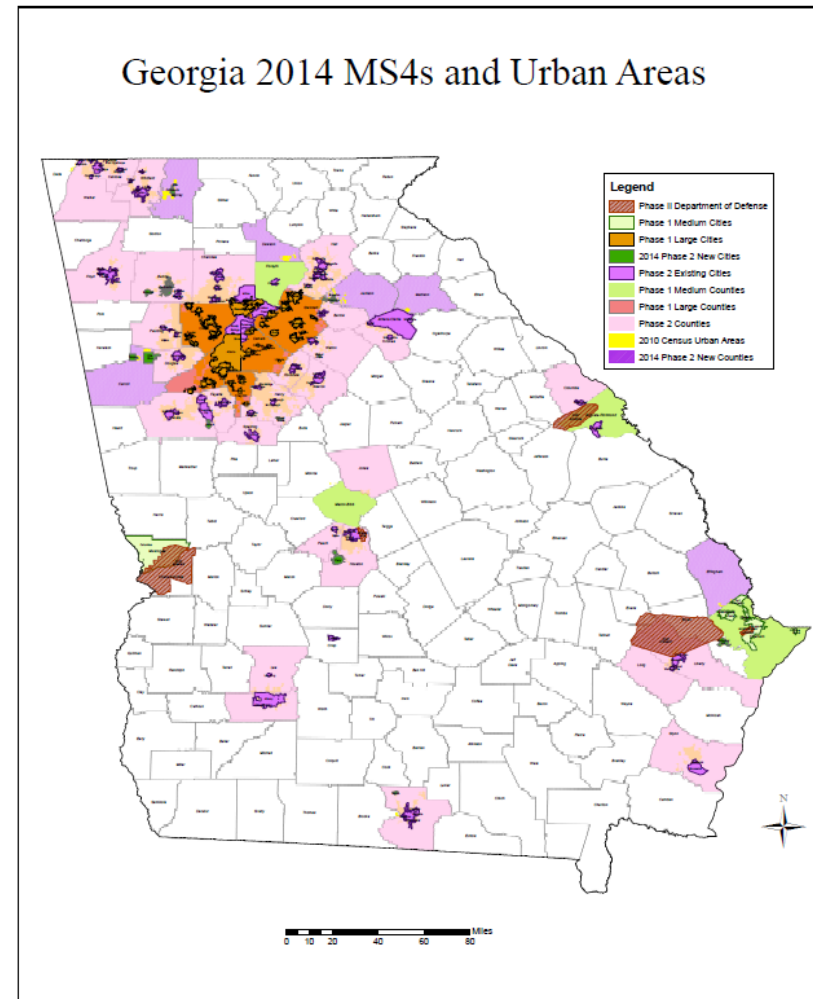

The National Pollutant Discharge Elimination System (NPDES) permit system was originally established by the Clean Water Act of 1972 to control wastewater discharges from various industries and wastewater treatment plants known as “point” sources. Congress amended the Clean Water Act with the Water Quality Act of 1987 to expand the NPDES permit program to address “non-point” source pollution. The Municipal Separate Storm Sewer System (MS4) stormwater discharge permitting program under the NPDES regulations establishes requirements for municipalities to minimize pollutants in stormwater runoff to the “maximum extent practicable.”

Under Georgia EPD’s Municipal Separate Storm Sewer System (MS4) permit program, local governments in regulated areas are required to establish a comprehensive stormwater management program (SWMP), develop a plan and program to control stormwater pollution discharges to waters of the State to the maximum extent practical, and eliminate non-stormwater discharges from entering the stormwater system.

This is accomplished through the implementation of a municipal program which includes such measures as structural and non-structural stormwater controls, development standards, best management practices (BMPs), regular inspections, enforcement activities, stormwater monitoring and public education efforts. Stormwater management ordinances, erosion and sediment control ordinances, development regulations and other local regulations provide the necessary legal

authority to implement the stormwater management programs.

Phase I communities are issued individual MS4 permits, while Phase II communities are regulated under a general permit, rather than receiving an individual MS4 permit

### 2.5.1 MS4 Phase I Permits

Since 1993, the Phase I permit requirements have been applied in Georgia to large and medium municipal separate storm sewer systems (defined by a population greater than 250,000 and population between 100,000 and 250,000, respectively). Phase 1 permits typically include requirements on the following :

- Structural and Source Control Measures
  - » Stormwater System Mapping
  - » Stormwater System Inspection and Maintenance
  - » Street Maintenance and Cleaning
  - » Evaluation of Flood Management Projects
  - » Inventory and Inspection of Municipal Waste Facilities
  - » Program to Reduce Pesticide, Fertilizer, and Herbicide Pollution
- Illicit Discharge Detection & Elimination Program
- Industrial Facility Stormwater Runoff Control Program
- Inventory and Inspection of Highly Visible Pollutant Sources
- Construction Site Management Program
- Post-Construction Development Standards

- Employee Training Programs
- Impaired Water Monitoring Plan for 305(b)/303(d) Listed Areas
- Public Education and Public Involvement Programs
- Green Infrastructure Inventory, Inspection and Maintenance Programs
- Enforcement Response Plan

Within each permit issued, requirements are defined and explained for how the community should meet the permit standards. As of 2015, the Phase I program includes the following jurisdictions:

Acworth	Jonesboro
Alpharetta	Kennesaw
Atlanta	Lake City
Austell	Lawrenceville
Avondale Estates	Lilburn
Berkley Lake	Lithonia
Bloomingtondale	Lovejoy
Buford	Macon-Bibb County
Chamblee	Marietta
Chatham County	Morrow
Clarkston	Norcross
Clayton County	Palmetto
Cobb County	Pine Lake
College Park	Pooler
Columbus	Port Wentworth
Dacula	Powder Springs
Decatur	Richmond County
DeKalb County	Riverdale
Doraville	Roswell
Duluth	Savannah
East Point	Smyrna
Fairburn	Snellville
Forest Park	Stone Mountain
Forsyth County	Sugar Hill
Fulton County	Suwanee
Garden City	Thunderbolt
Grayson	Tybee
Gwinnett County	Union City
Hapeville	

## Georgia 2014 MS4s and Urban Areas

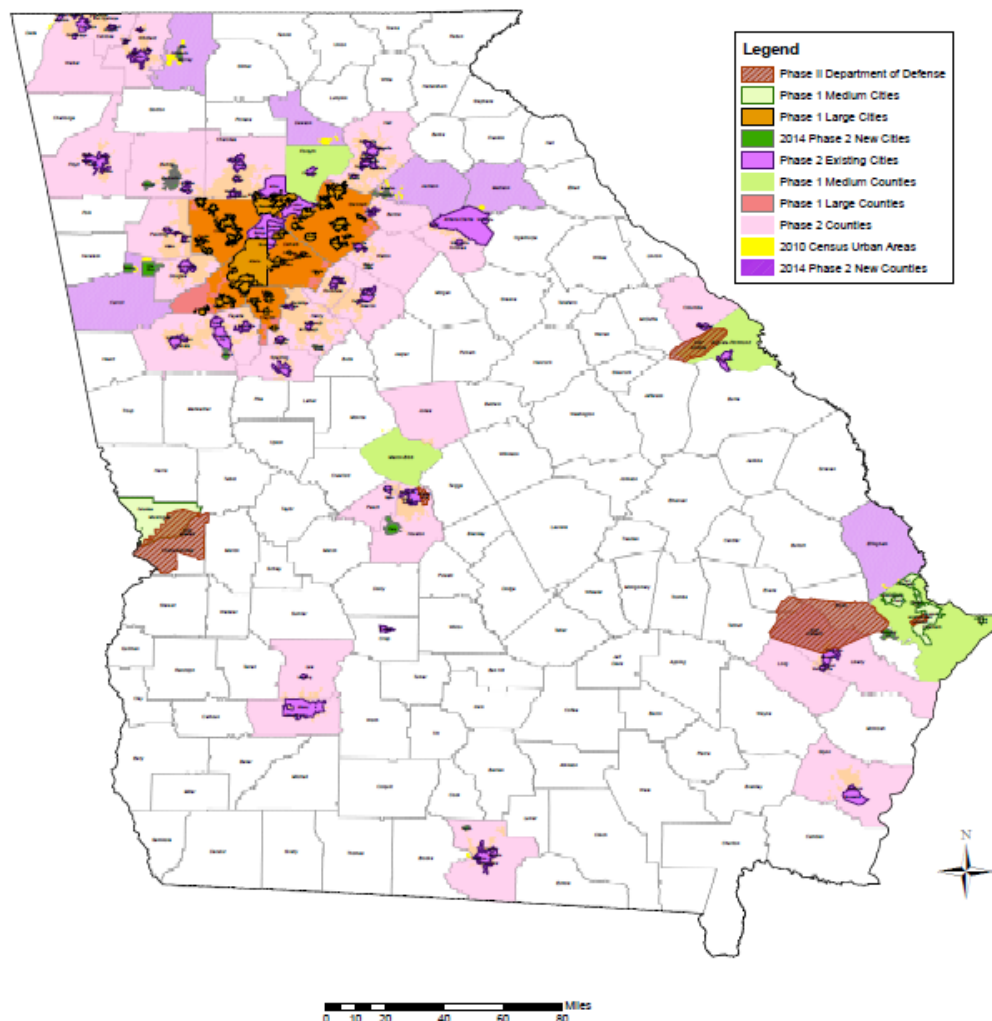

Figure 2.5-1 Phase I and Phase II MS4 Communities in Georgia

Note: For some counties, the MS4 permit covers the entire county, while for others the MS4 permit covers only the urbanized area of the county.)

Source: Georgia Environmental Protection Division

### 2.5.2 MS4 Phase II Permits

Federal regulations were adopted in 1999 to extend the NPDES MS4 permit program to smaller (Phase II) communities, with populations below 100,000. Phase II rules take a slightly different approach for implementing local stormwater management programs by requiring the SWMP to consist of six "minimum control measures." The six minimum control measures are listed below, with excerpts from the General NPDES Stormwater Permit for Stormwater Discharges Associated with Small Municipal Separate Storm Sewer Systems. Guidance on developing a stormwater management program that complies with the six minimum measures can be found here: <http://epd.georgia.gov/storm-water>, and the EPA has developed helpful fact sheets on each minimum measure: <http://www3.epa.gov/npdes/pubs/fact2-9.pdf>.

1. Public Education and Outreach on Storm Water Impacts “The permittee must implement a Public Education Program to distribute educational materials to the community and/or conduct equivalent outreach activities about the impacts of stormwater discharges on water bodies and the steps that the public can take to reduce pollutants in storm water runoff.” EPA’s Nonpoint Source (NPS) Outreach Toolbox (<http://cfpub.epa.gov/npstbx>) provides many resources for developing a public education and outreach program.
2. Public Involvement / Participation “The permittee must, at a minimum, comply with State and local public notice requirements when implementing a public involvement / participation program. The permittee is encouraged to make the approved SWMP publicly accessible electronically or by other means.” EPA’s Public Involvement / Participation website provides many resources for developing a public outreach program: <http://www.epa.gov/international-cooperation/public-participation-guide-internet-resources-public-participation>
3. Illicit Discharge Detection and Elimination (IDDE) “The permittee must develop, implement and enforce a program to detect and eliminate illicit discharges...into its MS4.” The Center for Watershed Protection’s manual, Illicit Discharge Detection and Elimination: A Guidance Manual for Program Development and Technical Assessments, details all of the techniques involved in developing an effective IDDE program: <http://www.cwp.org/online-watershed-library/>
4. Construction Site Storm Water Runoff Control “The permittee must develop, implement and enforce a program to reduce pollutants in any storm water runoff to the MS4 from construction activities that result in a land disturbance of greater than or equal to one acre. Storm water discharges from construction activity disturbing less than one acre must be included in the permittee’s program if that construction activity is part of a larger common plan of development or sale that would disturb one acre or more.” Information on developing a construction site runoff control program can be found on the EPA fact sheet: <http://www3.epa.gov/npdes/pubs/fact2-6.pdf>
5. Post-Construction Storm Water Management in New Development and Redevelopment “The permittee must develop, implement and enforce a program to address storm water runoff into the MS4 from new development and redevelopment projects, including projects less than one acre if they are part of a larger common plan of development or sale... The program must ensure that controls are in place that will prevent or minimize water quality impacts. At a minimum, the Post-Construction Storm Water Management in New Development and Redevelopment Program must contain the following requirements:
  - » Develop and implement strategies which include a combination of structural and/or non-structural BMPs appropriate for your community;
  - » Use an ordinance or other regulatory mechanism to address post-construction runoff from new development and redevelopment projects to the extent allowable under State and local law; and
  - » Ensure adequate long-term operation and maintenance of the BMPs.
  - » Develop an inventory of GI/LID Structures”
6. Pollution Prevention / Good Housekeeping for Municipal Operations “The permittee must develop and implement an operation and maintenance program that includes a training component with the ultimate goal of preventing or reducing pollutant runoff from municipal operations. Using training materials available from the USEPA and other organizations as guidance, the permittee must, as a part of this program, include employee training to prevent and reduce storm water pollution from activities such as park and open space maintenance, fleet and building maintenance, new construction and land disturbances, and storm water system maintenance.” The Center for Watershed Protection’s manual, Urban Subwatershed Restoration Manual Series Manual 9: Municipal Pollution Prevention / Good Housekeeping Practices provides “how to” guidance on pollution prevention and good housekeeping activities: <http://www.cwp.org/online-watershed-library/>

Section 4.2 includes recommended standards for post-construction stormwater management in Georgia.

As of 2015, the following communities are Phase II MS4s:

Albany (Dougherty County)	Flowery Branch (Hall County)	Newnan (Coweta County)
Allenhurst (Liberty County)	Floyd County	Newton County
Athens-Clarke County	Fort Benning	Oakwood (Hall County)
Auburn (Barrow County)	Fort Gordon	Oconee County
Barrow County	Fort Oglethorpe (Catoosa County)	Oxford (Newton County)
Bartow County	Fort Stewart	Paulding County
Bogart (Oconee County)	Gainesville (Hall County)	Peach County
Braselton (Jackson County)	GDOT	Peachtree City (Fayette County)
Brookhaven (DeKalb County)	Glynn County	Peachtree Corners (Gwinnett)
Brunswick (Glynn County)	Griffin (Spalding County)	Perry (Houston County)
Byron (Peach County)	Grovetown (Columbia County)	Porterdale (Newton County)
Canton (Cherokee County)	Hahira (Lowndes County)	Remerton (Lowndes County)
Carroll Co.	Hall County	Richmond Hill (Bryan County)
Cartersville (Bartow County)	Hampton (Henry County)	Ringgold (Catoosa County)
Catoosa County	Henry County	Robins AFB
Centerville (Houston County)	Hephzibah (Richmond County)	Rockdale County
Chatsworth (Murray County)	Hinesville (Liberty County)	Rome (Floyd County)
Cherokee County	Hiram (Paulding County)	Rossville (Walker County)
Chickamauga (Walker County)	Holly Springs (Cherokee County)	Sandy Springs (Fulton County)
Columbia County	Hoschton (Jackson County)	Senoia (Cowweta County)
Conyers (Rockdale County)	Houston County	Spalding County
Cordele (Crisp County)	Hunter AAF	Stockbridge (Henry County)
Covington (Newton County)	Jackson Co.	Temple (Carroll County)
Coweta County	John's Creek (Fulton County)	Tunnel Hill (Whitfield County)
Cumming (Forsyth County)	Jones County	Tyrone (Fayette County)
Dallas (Paulding County)	Lee County	Valdosta (Lowndes County)
Dalton (Whitfield County)	Leesburg (Lee County)	Varnell (Whitfield County)
Dawson Co.	Liberty County	Villa Rica (Carroll County)
Dougherty County	Locust Grove (Henry County)	Walker County
Douglasville-Douglas County WSA (Douglas County)	Loganville (Walton County)	Walnut Grove (Walton County)
Dunwoody (DeKalb)	Long County	Walthourville (Liberty County)
Effingham Co.	Lookout Mountain (Walker County)	Walton County
Emerson (Bartow County)	Lowndes County	Warner Robins (Houston County)
Eton (Murray County)	Madison Co.	Watkinsville (Oconee County)
Euharlee (Bartow County)	McDonough (Henry County)	Whitfield County
Fayette County	Milton (Fulton County)	Winterville (Clarke County)
Fayetteville (Fayette County)	Mountain Park (Fulton County)	Woodstock (Cherokee County)
Flemington (Liberty County)	Murray Co.	



## 2.6 Other Related Regulatory Requirements

**Description:** In addition to the MS4 Permit, other regulatory requirements exist to address point and nonpoint source pollution and stormwater quality. These programs, permits, and acts were created to provide businesses, industries, and the public with standards for preserving or improving water quality.



### KEY CONSIDERATIONS

MS4 permits are not the only regulatory requirement related to non-point source pollution and stormwater quality. Numerous federal and state requirements define what is required of local governments and others in preserving or improving water quality. The regulatory requirements discussed in this section include:

- Industrial NPDES Stormwater Permit Program
- NPDES Stormwater Permits for Construction Areas
- NPDES Municipal Wastewater Discharge Permit Program and Watershed Assessments
- Erosion and Sedimentation Control Act
- Total Maximum Daily Load (TMDL) Program
- Georgia Planning Act
  - River Corridor Protection
  - Water Supply Watersheds
  - Groundwater Recharge Areas
- Safe Drinking Water Act – Wellhead Protection Program
- Source Water Assessment Program (SWAP)
- Metropolitan River Protection Act (Atlanta metro area only)
- Wetlands – Federal 404 Permits and the Georgia Planning Act
- Coastal Management Program
- Coastal Marshlands Protection Act
- Georgia Greenspace Program



### 2.6.1 Industrial NPDES Stormwater Permit Program

In addition to MS4 regulation, the NPDES program also requires that the discharge of stormwater from certain types of industrial facilities be regulated under a permit program. Industrial stormwater is defined as that discharged from any conveyance that is used for collecting and conveying stormwater, which is directly related to manufacturing, processing, or materials storage areas. Discharge of stormwater from regulated industrial facilities is managed under a single general permit that was re-issued by Georgia EPD in 2012.

Currently, nine categories of industrial facilities are required to have an industrial stormwater NPDES permit in Georgia for their stormwater discharge. These include:

- Manufacturing facilities, such as paper mills, chemical plants, and timber mills
- Mining, oil, and gas operations
- Hazardous waste treatment, storage, or disposal facilities
- Recycling facilities
- Steam electric power generating facilities
- Transportation facilities
- Facilities treating domestic sewage or sewage sludge
- Landfills, land application sites, and open dumps
- Facilities subject to effluent guidelines and new performance standards under 40 CFR Subchapter N (for example, cement and

phosphate manufacturing; petroleum refining; coal, ore and mineral mining; asphalt, etc.)

- Construction activities

See Appendix D of GAR05000, the Industrial Stormwater General Permit, for a list of Standard Industrial Classification (SIC) codes that require coverage.

New industrial facilities are required to submit a Notice of Intent 7 days prior to commencing discharge. Provisions of the permit require preparation of a Stormwater Pollution Prevention Plan and annual certification of plan implementation. Industrial facilities must comply with the requirements of the general industrial stormwater permit, including preparation of Stormwater Pollution Prevention Plans and submittal of Annual Reports.

### 2.6.2 NPDES Stormwater Permits for Construction Areas

The NPDES stormwater permits for construction activities are directed toward controlling the quality of stormwater runoff from construction activities. The permits emphasize the application of best management practices to control erosion and sedimentation processes during the construction phase of development (similar to the Erosion and Sedimentation Act below). Construction managers need to obtain stormwater permits from Georgia EPD by filing a Notice of Intent (NOI) prior to initiating construction activities that disturb an area equal to or greater than one acre ([See Section 2.6.4](#))

### 2.6.3 NPDES Municipal Wastewater Discharge Permit Program and Watershed Assessments

Georgia local governments applying for new or expanded NPDES permits with municipal wastewater treatment facilities of at least 1 million gallons per day are required by the Georgia EPD to develop and implement comprehensive watershed assessments and protection plans for the areas within their political boundaries. These plans encompass point and nonpoint sources and document best management practices to improve water quality. The plans are part of EPD's implementation of the US EPA's Total Maximum Daily Load (TMDL) program ([see Section 2.3](#)).

### 2.6.4 Erosion and Sedimentation Control Act

The Erosion and Sedimentation Control Act (ESCA) was established for controlling erosion and sedimentation from land-disturbing activities. Georgia law directs local governments to enact erosion and sedimentation ordinances. These ordinances require that permits be obtained for land-disturbing activities within the jurisdiction. Permit applicants must submit an erosion and sedimentation control plan that incorporates specific conservation and engineering practices, known as best management practices (BMPs).



The ESCA includes special requirements for land-disturbing activities in stream buffer zones. Land disturbing activities are not allowed within 25 horizontal feet of any State waters with wooded vegetation unless a variance is granted by EPD. The Act also includes special requirements for trout streams.

This program relates directly to requirements under the NPDES stormwater Permits for Construction Areas (See Section 2.6.2), as that program also requires sediment and erosion controls for all disturbed areas greater than one acre. One erosion and sediment control plan for a site will typically suffice for the NPDES and state erosion and sedimentation control permit requirements.

### **2.6.5 Total Maximum Daily Load (TMDL) Program**

Under Section 303(d) of the Clean Water Act, the State of Georgia is required to develop a list of impaired waters that do not meet water quality standards and require a Total Maximum Daily Load (TMDL) to be developed. The Georgia EPD must then establish priority rankings for waters on the list and develop Total Maximum Daily Loads (TMDLs) for the listed waters. The TMDL specifies the maximum amount of a specific pollutant of concern that a designated segment of a water body can receive and still meet water quality standards. The TMDL also allocates the pollutant loadings among both point and nonpoint pollutant sources, including stormwater runoff. A number of TMDLs have been issued for water bodies across the state.

For each pollutant identified, a TMDL implementation plan is developed. The implementation plan identifies sources of the pollutant and provides a list of actions or management measures needed to reduce the pollutant, a schedule for implementing controls, milestones for implementation, and a monitoring program to measure progress. Controls and management measures need to be in place five years after the plan is developed. The TMDL program has a broad impact on local stormwater management programs because nonpoint sources of pollutants must be addressed at the local level.

### **2.6.6 Georgia Planning Act**

The Georgia Planning Act (GPA) was created and implemented to help communities plan ahead for development. It takes coordination and planning at the local, regional, and state levels to properly develop a community. Within the planning act, there are different methods to help plan new development areas while protecting nearby waters and natural areas.

#### **2.6.6.1 RIVER CORRIDOR PROTECTION**

The GPA establishes corridors along some large rivers as critical natural resource areas. The river corridors and other critical natural resources are to be protected through comprehensive planning at the local levels. Each local government with a protected river in its jurisdiction is directed to develop and implement a river corridor protection plan that meets minimum planning standards established by the Georgia EPD. Minimum standards are designed to protect large rivers from

the impacts of human activities on land immediately adjacent to the river (100 feet on each side). Communities must comply with the requirements of the state's River Corridor Protection criteria if stormwater activities are within the protected areas of this plan.

#### **2.6.6.2 WATER SUPPLY WATERSHEDS**

The GPA identifies water supply watersheds as key natural resources and sets regulatory activities to protect the quality and quantity of water available from watersheds that are used for public water supply. Water supply watersheds are defined as land contained within a drainage basin that has a governmentally-owned public drinking water intake downstream. Georgia EPD requires that development and associated stormwater runoff within the watershed not contaminate the water source to a point where the water cannot be treated to meet drinking water standards. Reservoir management plans must be submitted to EPD for all reservoirs in water supply watersheds. Requirements are specified based on the type of water supply watershed (small or large) and on the location, as shown in Table 2.6-1.

Table 2.6-1 Minimum Criteria for the Protection of Water Supply Watersheds in Georgia

Watershed Size (mi <sup>2</sup> )	Reservoir Present?	Vegetative Buffer around Reservoir (ft)	Vegetative Buffer along Perennial Streams (ft)		Setback for Impervious Surfaces along Perennial Streams (ft)		Overall Impervious Surface Density
			within 7 mile radius*	outside radius*	within 7 mile radius*	outside radius*	
> 100	No	none	none	none	none	none	no criteria
> 100	Yes	150	100	none	150	none	no criteria
> 100	No	none	100	50	150	75	25% or less
> 100	Yes	150	100	50	150	75	25% or less

\* "7 mile radius" means within 7 miles upstream of a reservoir boundary if present or of the surface water intake if no reservoir is present

The water supply watershed requirements provide for the development of alternative criteria to these standards. Alternative criteria must provide equal or better protection of the water supply watershed, and all local governments within the watershed must approve of and adopt the criteria.

### 2.6.6.3 GROUNDWATER RECHARGE AREAS

The GPA identifies groundwater recharge areas as key natural resources. The Georgia EPD has established minimum criteria for groundwater recharge areas in order to prevent groundwater contamination from development. These criteria are to be incorporated within local comprehensive plans. In Georgia, minimum criteria have only been established for the most significant recharge areas, which cover approximately 23 percent of the state. For new residences served by septic systems, the criteria specify minimum lot sizes greater than those required for residences not in a significant recharge area. Permanent stormwater infiltration basins are prohibited in areas having high pollution susceptibility.

### 2.6.7 Safe Drinking Water Act – Well-head Protection Program

Under the Federal Safe Drinking Water Act (FSDWA), Georgia EPD administers a wellhead protection program to protect public water supplies that use groundwater. Wellhead protection is the practice of managing an area around a water well or spring to prevent any contaminants released at the ground's surface from reaching the subsurface drinking water. Within the wellhead protection area, some stormwater management activities involving the infiltration of runoff, particularly from hotspot areas, may be limited or prohibited.

### 2.6.8 Source Water Assessment Program (SWAP)

The 1996 amendments to the FSDWA brought about a new program for clean and safe drinking water served by public water supplies, known as the Source Water Assessment Program (SWAP). The U.S. EPA is advocating prevention as an important tool in the protection of public drinking water sources from contamination. In order

to implement source protection, an assessment of potential pollutant sources in water supply watersheds must be conducted. The goals of this assessment project will be reached through implementation of a four-step method, which includes watershed delineation, inventory of potential pollutant sources within the watershed, analysis of susceptibility of a water intake to the pollutant sources, and communication of this information to the public.

As many pollutants can enter waterways and reservoirs through stormwater drainage systems, SWAP efforts will provide an informational resource for local stormwater pollution prevention and mitigation programs. Future water supply protection efforts to control the identified potential pollution sources should be coordinated with and included as part of a local stormwater program.

### **2.6.9 Metropolitan River Protection Act (Atlanta metro area only)**

The Metropolitan River Protection Act (MRPA) was passed by the Georgia General Assembly in 1973, in recognition of the Chattahoochee River's value as a resource and its vulnerability to the effects of urban development. The stated purposes of the MRPA include protection of water quality, erosion control, reduction of flood hazards, protection of recreational values, and protection of property rights. The MRPA created a corridor extending 2,000 feet from each bank of the Chattahoochee and its impoundments, which originally covered the 48 miles of river between Buford Dam and Peachtree Creek. In 1984, the MRPA was amended to require local governments in the river basin to adopt buffer zone ordinances for tributaries outside of the 2,000 foot corridor. In 1998, the MRPA was amended again to extend the corridor to the downstream limits of Fulton and Douglas Counties.

The MRPA authorizes the Atlanta Regional Commission to adopt a plan for the corridor that established criteria for all land-disturbing activity to protect the corridor's land and water resources. All land-disturbing projects and proposed activities in the corridor are subject to review for consistency with the standards of the adopted Corridor Plan. These standards include: natural vegetative buffers and impervious surface setbacks along the river and tributary streams, limits on land disturbance and impervious surface, and requirements in the river floodplain. Outside of the corridor, projects need to adhere to the local tributary buffer requirements.

### **2.6.10 Wetlands – Federal 404 Permits and the Georgia Planning Act**

The U.S. Army Corps of Engineers administers a permit program for activities in, on, or around waters of the U.S. Regulated activities include excavating, dredging, or depositing fill materials into waters of the U.S. The permit program protects wetlands and all "waters of the United States" across Georgia. Waters of the U.S. include all surface waters, such as coastal and navigable inland waters, lakes, rivers, streams and their tributaries; interstate waters and their tributaries; wetlands adjacent to the above (e.g. swamps, marshes, bogs, or other land areas); and isolated wetlands and lakes, intermittent streams, and other waters where degradation could affect interstate commerce. Section 404 permits (and possibly Section 10 permits) are required for stormwater activities that may impact natural wetlands.

Protection of wetlands in Georgia is also accomplished through comprehensive planning and ordinances at the local level through the Georgia Planning Act. The GPA establishes provisions for planning by local governments and authorizes the DNR to develop minimum planning standards for the protection of critical natural resources, including wetlands.

### **2.6.11 Coastal Management Program**

The state Coastal Management Program (CMP) was recently developed to establish Georgia as a participant in the federal Coastal Zone Management Act (CZMA) of 1972. The goal of the CMP is to balance economic development in Georgia's coastal zone with preservation of nat-

ural, environmental, historic, archeological, and recreational resources. The program establishes a network of federal, state, and local agencies to address coastal issues. Activities under the program include permitting, planning, resource protection, and economic development activities. Requirements of the CZMA are designed to protect marshlands and include use of stormwater controls in critical areas near the coast to reduce the discharge of urban stormwater pollutants. The requirements are similar to those anticipated under the NPDES Phase II regulations.

### **2.6.12 Coastal Marshlands Protection Act**

The Coastal Marshlands Protection Act (CMPA) manages certain activities and structures in marsh areas and requires permits for other activities and structures. The jurisdiction of the CMPA includes marshlands, intertidal areas, mudflats, tidal water bottoms, and salt marsh areas within estuarine areas of the state. The estuarine area is defined as all tidally influenced waters, marshes, and marshlands lying within a tide-elevation range from 5.6 feet above mean high-tide level and below.

A Marshlands Protection Permit administered through the DNR's Coastal Resources Division is required for any project that involves removing, filling, dredging, draining, or otherwise altering any marshlands. In cases where the proposed activity involves construction on state-owned tidal water bottoms, a Revocable License issued by the Coastal Resources Division may also be required.

## 2.7 Unregulated Communities

Any community that is not classified as a NPDES Phase I or Phase II MS4 community is considered an unregulated community. Qualifications for Phase I and Phase II communities are identified in [Section 2.5](#). Unregulated communities are typically small or rural areas without the population (at least 100,000 people) to qualify as a Phase I community or sufficient urbanized area to qualify as a Phase II community. Phase I and Phase II communities are required to develop a comprehensive stormwater management program, which incorporates many recommendations and requirements from the Georgia Stormwater Management Manual (GSMM). While unregulated communities do not have the same requirements placed on them, they are certainly not immune to the negative effects of stormwater runoff, such as flooding and water quality degradation. By implementing a program to address both stormwater quantity and quality, unregulated communities can protect themselves and nearby communities from these hazards. Several aspects of the GSMM will be beneficial to unregulated communities:

- The better site design principles listed in [Chapter 3](#) will help any community implement low impact development (LID) projects and policies.
- The standards for development described in [Chapter 4](#) present a uniform way to guide and/or regulate growth and development in the community, in line with other communities in the state.
- The BMPs described in [Volume 2, Chapter 4](#) represent the best available strategies for protecting water resources from the impacts of development.

### CASE STUDY

#### Better Site Design and Low Impact Development in Clarksville

The City of Clarksville, Georgia is a small, fast-growing community interested in developing a green infrastructure plan. The city's municipal separate storm sewer system is not subject to state or federal requirements to address stormwater pollution. However, the city has proactively addressed stormwater quality and quantity through post-construction stormwater requirements and supporting the use of green infrastructure for stormwater management.

In April 2014, the U.S. Environmental Protection Agency (USEPA) announced the selection of 14 communities to receive \$860,000 in green infrastructure technical assistance. The City of Clarksville received technical assistance in the form of a Green Infrastructure Implementation Strategy. USEPA identified opportunities for improving the city's Zoning Ordinance to encourage implementation of green infrastructure by developers, property owners, and other parties. The following key opportunities were identified:

- Reduce street and parking dimensions
- Offer incentives for redevelopment
- Reduce setbacks
- Require phased disturbance of vegetated areas
- Require minimization of hydrologic alteration to wetlands
- Increase stream buffer width

- Require a Best Management Practice (BMP) Maintenance Plan for all stormwater facilities
- Develop additional stormwater performance standards for new development and redevelopment

By outlining goals, priorities, code improvements, project opportunities, and funding sources, the City of Clarksville's strategy provides a model approach for small, unregulated communities to successfully pursue green infrastructure.



Figure 2.7-1 Clarksville Green Infrastructure Implementation Strategy

## References

American Planning Association. 2015. [Planning and Community Health Center](#). American Planning Association.

American Public Health Association. 2013. ["Improving Health and Wellness through Access to Nature"](#). American Public Health Association.

Brown, Edward, Deb Caraco, and Robert Pitt. 2004. [Illicit Discharge Detection and Elimination: A Guidance Manual for Program Development and Technical Assessments](#). Center for Watershed Protection, Ellicott City, MD & University of Alabama, Tuscaloosa, AL.

Georgia Environmental Protection Division. 2013. [NPDES Construction Storm Water General Permits](#). Georgia Environmental Protection Division.

Georgia Environmental Protection Division. [Storm Water](#). Georgia Environmental Protection Division.

Georgia Environmental Protection Division. [Authorization to Discharge Under the National Pollutant Discharge Elimination System](#). Georgia Environmental Protection Division.

Georgia Environmental Protection Division. 2013. [Georgia Water Quality Standards](#). Georgia Environmental Protection Division.

Hirschman, David J., John Kosco. 2008. [Managing Stormwater in Your Community: A Guide for Building an Effective Post-Construction Program](#). Center for Watershed Protection, Ellicott City, MD.

Novotney, Michael and Rebecca Winer. 2008. [Manual 9: Municipal Pollution Prevention/Good Housekeeping Practices](#). Center for Watershed Protection, Ellicott City, MD.

Radeloff, V. C., R. B. Hammer, S. I. Stewart, J. S. Fried, S. S. Holcomb, and J. F. McKeefry. 2005. [The Wildland Urban Interface in the United States](#). Ecological Society of America.

Schueler, T. R., P. A. Kumble, and M. A. Heraty. 1992. [A Current Assessment of Urban Best Management Practices: Techniques for Reducing Non-Point Source Pollution in the Coastal Zone](#). Department of Environmental Programs.

U.S. Environmental Protection Agency. [Stormwater Phase II Final Rule Fact Sheet Series](#). U.S. Environmental Protection Agency, Washington D.C.

## 3. Better Site Design

### 3.1 Introduction to Better Site Design

Addressing stormwater management begins with the site planning and design process. Development projects can be designed to reduce their impact on watersheds when efforts are made to conserve natural areas, reduce impervious cover, and better integrate stormwater treatment. By implementing a combination of these nonstructural approaches, collectively known as Better Site Design (BSD), it is possible to reduce the amount of runoff and pollutants generated by a site and provide for some nonstructural on-site treatment and control of runoff. The goals of Better Site Design include:

- Preventing stormwater impacts rather than mitigating them
- Managing stormwater (quantity and quality) as close to the point of origin as possible and minimizing collection and conveyance
- Utilizing simple, nonstructural methods for stormwater management that are lower cost and lower maintenance than structural controls
- Creating a multifunctional landscape
- Using hydrology as a framework for site design

Terminology can be confusing with stormwater management concepts. As discussed in [Section 1.5](#), “Low-Impact Development” (LID), “Green

Infrastructure”, and “Better Site Design” (BSD) have similar and overlapping goals. All of these terms refer to goals of replicating natural hydrology at development sites, preserving key natural resources, and treating stormwater close to its source with distributed and often vegetated practices. This manual uses LID as the overarching term for these goals and practices, and the focus of this chapter is BSD, referring to a group of generally non-structural and policy-related practices that direct development to appropriate areas, preserve natural features that aid in water management, and minimize impervious cover. The publication “Better Site Design: A Handbook for Changing Development Rules in Your Community” from the Center for Watershed Protection (1998b) provides additional guidance on implementing BSD practices.

Better Site Design is also related to the concept of “smart growth”. While BSD refers to how development is conducted at the scale of an individual site or neighborhood, smart growth is a concept that operates at a broader, community-wide scale, and is more concerned with where development takes place. Smart growth directs a community’s development to areas with existing infrastructure (e.g., infill and redevelopment), while avoiding new growth (or sprawl) in the countryside. Smart growth can be the backbone of a community’s land use strategy, and is addressed in this chapter as a tenet of community planning.



**Table 3-1: Benefits of BSD for Various Parties, as Compared to Conventional Development****Developers:**

- Provides flexibility in design options
- Allows for more sensible locations for stormwater facilities
- Facilitates compliance with wetland and other regulations
- Allows for reduced development costs, especially for stormwater infrastructure

**Local Government:**

- Improves quality of life for residents
- Facilitates compliance with wetland and other regulations
- Assists with compliance for NPDES MS4 permits, TMDL requirements, etc.
- Increases local property tax revenues due to higher home values
- Can allow for development in communities otherwise limited by sewer capacity

**Property Owners:**

- Increases property values
- Creates more pedestrian-friendly neighborhoods
- Provides open space for recreation
- Results in a more attractive landscape
- May reduce car speed on residential streets
- Promotes neighborhood designs that provide a sense of community
- Reduces water and energy demands

**Environment:**

- Protects sensitive forests, wetlands, and wildlife habitats
- Protects the quality of local streams and lakes
- Generates reduced loads of stormwater pollutants
- Allows more recharge of groundwater supply
- Reduces erosion and sedimentation during construction and for the life of the development
- Reduces noise and air pollution
- Reduces urban heat island
- Reduces atmospheric carbon dioxide

Table 3-1 outlines some of the benefits of using BSD for various parties involved in the development process.

Better Site Design aims to protect and conserve natural areas, reduce impervious cover, and integrate stormwater management with site design. These principles can provide notable reductions in post-construction stormwater runoff rates, volumes, and pollutant loads. Also, they can reduce development costs and increase property values (MacMullin and Reich, 2007; Winer-Skonovd et al., 2006; US EPA, 2007). BSD techniques are applied most readily on new residential and commercial development projects. In addition, many of the techniques are applicable to redevelopment or infill scenarios as part of a smart growth strategy. While some of these principles can be applied easily by a developer, others may require changes in local regulations ([see Section 3.2](#)).





## CASE STUDY

### Southface Eco Office, Atlanta, Georgia

The award-winning Southface Eco Office, located in downtown Atlanta, is a three-story commercial structure that serves as an office, training and demonstration facility. At 10,100 square feet, it is similar in size to many commercial buildings, making it a strong example for what can be achieved in energy-, water- and resource-efficiency within the commercial building sector. It is also one of the most sustainable office facilities in the world, using 84 percent less water and 53.3 percent less energy than a comparable, code-built facility.

The following Better Site Design and LID practices were used on the Southface property: water efficient landscaping, permeable pavement, a vegetated swale, underground and rainwater cisterns, shared parking, and a green roof.

The Eco Office is fully instrumented so that performance can be measured on a continuous basis. This performance information is available online at <http://www.buildingdashboard.com/clients/southface/> and provides real-time and historical data on daily gallons of rainwater captured, consumed, and saved and current rainwater levels in the building's cisterns, local weather conditions, and more ([www.southface.org](http://www.southface.org)).



Figure 3.1-1 Southface Eco Office  
(Source: [www.siteselection.com](http://www.siteselection.com))



Figure 3.1-2 South Face Eco Office Green Roof  
(Source: [www.vertical-theory.com](http://www.vertical-theory.com))

## 3.2 How to Make Your Local Development Codes Consistent with BSD Principles

Many communities across the country have found that their own local “development rules” (e.g., subdivision ordinances, zoning ordinances, parking lot and street design standards) prevent BSD techniques from being applied during the site planning and design process (CWP, 1998b). These communities have found that their own codes and ordinances are responsible for the wide streets, expansive parking lots, and large lot subdivisions that are crowding out the very natural resources they are trying to protect. Examples include the minimum parking ratios that many communities require for retail or commercial development and zoning restrictions that limit conservation development designs.

Some of the policy instruments that need to be reviewed for compatibility with the BSD principles include:

- Zoning Ordinances and Procedures
- Subdivision Codes
- Stormwater Management/Drainage Criteria
- Tree Protection/Landscaping Ordinances
- Buffer and Floodplain Regulations
- Erosion and Sediment Control Ordinances
- Grading Ordinances

- Street Standards/Road Design Manuals
- Parking Requirements
- Building and Fire Regulations and Standards
- Septic/Sanitary Sewer Regulations
- Local Comprehensive Plans

Obviously, it is difficult to make use of the recommended BSD techniques when local development codes restrict their use. It takes some time to work through the process of evaluating and eliminating these restrictions. Therefore, until these revisions have been completed and barriers to the use of BSD have been removed, site planning and design teams are encouraged to consult with the local development review authority to identify any local restrictions and work on potential solutions.

Table 3-2 provides a set of example questions that can be used to review a community’s local development codes and ordinances with the goal of streamlining implementation of BSD. The questions are organized by general BSD categories. The questions included in Table 3-2 are just examples of the types of questions that need to be asked. A more comprehensive analysis of local development regulations, with more concrete, in-depth questions should be conducted with the Codes and Ordinance Worksheet available in the Better Site Design manual (CWP, 1998b), [See http://www.cwp.org/online-watershed-library/](http://www.cwp.org/online-watershed-library/) and search page for “Codes and Ordinance

Worksheet” or a similar tool, such as EPA’s Water Quality Scorecard (<http://www.epa.gov/sites/production/files/2014-04/documents/water-quality-scorecard.pdf>).

Table 3-2 Questionnaire for Reviewing Local Regulations for Compatibility with BSD Principles

**CATEGORY 1: COMMUNITY PLANNING (SECTION 3.3.1)**

- |  |  |
|--|--|
| Community Planning, Infill and Redevelopment, Smart Growth | <ul style="list-style-type: none"> <li>• Does the community have incentives or other regulatory or non-regulatory means to promote infill and redevelopment in areas already served by infrastructure?</li> <li>• In general, is it more or less difficult for developers to build in already-developed areas versus greenfields?</li> </ul> |
|--|--|

**CATEGORY 2: SITE PLANNING and DESIGN (SECTION 3.3.2)**

- |                                  |  |
|----------------------------------|--|
| Natural Resources Inventory      | <ul style="list-style-type: none"> <li>• Is a natural resources inventory required or incentivized as part of the preliminary design?</li> <li>• Does the community have a land conservation, open space, or green space plan with which individual development sites can integrate?</li> <li>• Are there any incentives to developers or landowners to preserve land in a natural state (density bonuses, conservation easements, or lower property tax rates)?</li> </ul>  |
| Conservation of Natural Features | <ul style="list-style-type: none"> <li>• Is there a stream buffer ordinance in the community that provides for greater buffer requirements than the state minimums?</li> <li>• Do the buffer requirements include lakes, freshwater and tidal wetlands, or steep slopes?</li> <li>• Do the buffer requirements specify that at least part of the buffer be maintained with undisturbed vegetation?</li> <li>• Does the community restrict or discourage development in the 100-year floodplain?</li> <li>• Does the community restrict or discourage building on steep slopes?</li> </ul>  |
| Development Design               | <ul style="list-style-type: none"> <li>• Does the local permitting agency provide pre-application meetings, joint site visits, or technical assistance with site plans to help developers best fit their design concepts to the topography of the site and protect key site resources?</li> <li>• Are there development requirements that limit the amount of land that can be cleared in a multi-phase project?</li> <li>• Does the community allow and/or promote Planned Unit Developments (PUD's), which give the developer or site designer additional flexibility in site design?</li> <li>• Are open space or cluster development designs allowed?</li> <li>• Are the submittal or review requirements for open space designs greater than those for conventional development?</li> <li>• Are flexible site design criteria (e.g. setbacks, road widths, lot sizes) available for developers who utilize open space or cluster design approaches?</li> <li>• Does a minimum percentage of the open space have to be managed in an undisturbed natural condition?</li> </ul> |

## Tree Conservation and Tree Canopy

- Does the community have a tree or tree canopy cover protection ordinance?

- Is a minimum percentage of a parking lot required to be landscaped and/or planted with trees?

## Management of Open Space, Sustainable Landscaping

- Does the community have enforceable requirements to establish associations that can effectively manage open space?

- Is there adequate guidance for the managers of open space (e.g., homeowners' associations) on how to select and manage vegetation in a sustainable manner?

**CATEGORY 3: REDUCING IMPERVIOUS COVER (SECTION 3.3.3)**

## Reducing Roadway and Right-of-Way Width and Length

- Do road and street standards promote the most efficient site and street layouts that reduce overall street length?

- What is the minimum pavement width allowed for streets in low density residential developments?

## Alternative Roadway Components

- What is the minimum radius allowed for cul-de-sacs?

- Can a landscaped island be created within a cul-de-sac?

- Are alternative turnarounds such as "hammerheads" allowed on short streets in low density residential neighborhoods?

- Can "open-section" roads be utilized under certain conditions as an alternative to curb and gutter?

## Reducing Paved Parking and Walking Areas

- What are the minimum parking ratios for various development types?

- If mass transit is provided nearby, are parking ratios reduced?

- What is the minimum parking space size?

- What percentage of parking spaces are required to have smaller dimensions for compact cars?

- Is the use of shared parking arrangements promoted?

- Are there any incentives to developers to provide parking within structured decks or ramps rather than surface parking lots?

- Are there provisions or incentives for shared driveways, reduced setbacks to allow for shorter driveways, and/or use of permeable materials for driveways?

- Are sidewalk layouts (both sides vs. one side), widths, and material

## Reducing Building Footprints

- Does the community provide options for taller buildings and structures which can reduce the overall impervious footprint of a development?

Revising local development codes can seem overwhelming when one considers all of the questions in **Table 3-2**. However, these efforts can be scaled to the community’s capabilities and level of interest. The effort can be done in a comprehensive fashion or incrementally with an eye towards achieving key priorities. **Table 3-3** portrays three generalized levels of effort for code review, based on actual case studies on communities that have undertaken the process. Note that the categories represent a continuum, and hybrid or phased approaches are also possible. The table also lists anticipated staff time and costs for each level; however, those will vary between communities. For assistance with code and ordinance updates, see the James River Association’s Code and Ordinance Manual, which provides example ordinance language for many Better Site Design principles: <http://jrva.org/what-we-do/codes-and-ordinance-manual.pdf>

**Table 3-3 Different Levels of Effort to Revise Local Codes for Compatibility with BSD**

Level of Effort	Type of Code Review	Description
Low	High priority code changes to ensure consistency with stormwater management program	<ul style="list-style-type: none"> <li>• Relatively quick code housekeeping to identify and rectify inconsistencies and conflicts between stormwater management program/ordinance and other development codes, such as zoning, subdivision, and public safety.</li> <li>• Steer away from larger changes that are likely to be controversial, such as new stream buffer requirements or use of BMPs on individual lots.</li> <li>• Aim to have process complete within 6 months.</li> <li>• Approximate figure for code review: 75 – 100 hours, including code review, report, and meetings. Assume \$8,000 - \$10,000* if done by consultant.</li> <li>• Additional time and resources would be necessary to actually make the code changes, public involvement for code change meetings, etc.</li> </ul>
Moderate	Thorough code review to ensure consistency with stormwater management program and Better Site Design principles	<ul style="list-style-type: none"> <li>• Involves comprehensive code review by internal staff or consultant to identify broader topics to make codes more consistent with stormwater management.</li> <li>• Code recommendations should be prioritized so that 7 to 10 of the highest priority changes can be made, with longer range plan to make additional changes.</li> <li>• Aim to have process complete within 1 year, including stakeholder review (e.g., focus group) and public input.</li> <li>• Approximate figure for code review: 150 – 200 hours, including code review, report, and meetings. Assume \$17,000 - \$20,000* if done by consultant.</li> <li>• Additional time and resources would be necessary to actually make the code changes, public involvement for code change meetings, etc.</li> <li>• See example code changes from <b>Northern Shenandoah Valley Code Review</b> case study.</li> </ul>



Table 3-3 Different Levels of Effort to Revise Local Codes for Compatibility with BSD

Level of Effort	Type of Code Review	Description
High	Full roundtable process to achieve broad stakeholder involvement and consensus on code changes	<ul style="list-style-type: none"> <li>• Full stakeholder process involving comprehensive code review and stakeholder committees to vet and discuss the merits of various code changes. Individual committees may include: (1) roads and parking, (2) lot development, (3) natural resources management, and (4) stormwater.</li> <li>• Likely requires assistance from consultant.</li> <li>• Ideally results in consensus document of recommended code changes. More robust process can handle some issues that require more local discussion and debate.</li> <li>• Aim to have process complete within 2 to 3 years.</li> <li>• Approximate figure for code review: 600 – 750 hours, including code review, report, committee meetings, and consensus document. Assume \$80,000 - \$100,000* if done by consultant.</li> <li>• Additional time and resources would be necessary to actually make the code changes, public involvement for code change meetings, etc.</li> <li>• See CWP Roundtable case study below.</li> </ul>

\*Cost ranges approximated from Center for Watershed Protection code review project budgets between 2009 and 2012.



## CASE STUDY

### High Level of Effort Code and Ordinance Review: Full BSD Roundtable

Richland County, SC, completed a Site Planning Roundtable in 2009 (CWP, 2009). The roundtable process is a collaborative, consensus-building initiative designed to convene local government agencies, the development community, engineering and planning firms, and groups interested in environmental and conservation issues. The goal is to identify local hurdles to and opportunities for implementing Better Site Design and planning techniques, and to then build consensus across a diverse group of stakeholders on necessary local ordinance modifications to allow for them. The Site Planning Roundtable process in Richland County was modeled after the National Site Planning Roundtable (CWP, 1998a), the 22 Better Site Design Principles (CWP, 1998b) and four basic objectives:

- Reduce overall site impervious cover
- Preserve and enhance existing natural resources
- Integrate stormwater management
- Retain a marketable product

The first step was a thorough codes analysis based on results from: the Richland County Codes and Ordinances Worksheet (COW); an in-depth review of existing codes, ordinances, policies and regulations; and interviews conducted with developers, engineers, and County staff. The COW asks a series of questions organized around the Better Site Design Principles, which are based and scored on national benchmarks for Better Site Design. This analysis, completed by the Roundtable facilitators, provided a concise summary of the regulatory barriers to implementing Better Site Design in the county and served as the foundation for subcommittee discussions.

Subsequent to the code review, a kick-off meeting and site design exercise was conducted with all of the stakeholder groups, so that participants could gain an understanding of BSD principles. This was followed by a field trip to a development site that has several good examples of BSD applications.

Stakeholder committees were then convened to review current development practices involving four major categories: 1) Residential Streets and Parking Lots, 2) Lot Development, 3) Natural Resource Management, and 4) Stormwater Management. The committees met for approx-

imately 5 months through face-to-face meetings and conference calls. At the conclusion of the committee process, participants prepared a consensus document, which contains a variety of recommendations and action items. These actions will require follow-through from partners to see that the recommendations of the consensus document are implemented to successfully improve protection of Richland County's water resources, natural resources, and quality of life.



### Moderate Level of Effort Code and Ordinance Review: Northern Shenandoah Valley (Virginia) Code Review

The Northern Shenandoah Valley Regional Commission received a grant to assist their member jurisdictions (five counties) with reviewing their development codes in preparation for upcoming state-wide stormwater regulations. The purpose of the project was to quickly identify local code elements that would be in direct conflict with the stormwater regulations (Tier 1), as well as other code sections that could be changed to complement the stormwater program, such as implementation of BSD (Tier 2). A modified Codes and Ordinance checklist was developed based on these two tiers of review, and the actual code review and analysis was conducted by the Center for Watershed Protection. The result was a prioritized list of code changes. Table 3-4 illustrates examples of the types of code changes recommended for one of the Northern Shenandoah counties.

Table 3-4 Code Changes Recommended for Northern Shenandoah Valley Counties

Tier 1. Required Action for Stormwater Program Implementation	
Actions that are part of adopting a local stormwater program in accordance with the state stormwater regulations.	
Topic	Recommendation
Plan Submittal and Review	<ul style="list-style-type: none"> <li>The county code should be updated to include the required elements of a stormwater management plan consistent with the revised state manual.</li> <li>The existing stormwater maintenance provisions will need to be modified and/or transferred to the new stormwater regulations.</li> </ul>
Tier 2. Complementary Code Changes for Consistent Stormwater Implementation	
Code changes that are complementary and would promote BSD and low-impact development (LID).	
Topic	Recommendation
Stormwater Practices on Lots	<ul style="list-style-type: none"> <li>Authorize LID in other zoning districts besides open space cluster developments.</li> </ul>
Open Space/Common Area Within Subdivisions	<ul style="list-style-type: none"> <li>Add "stormwater treatment as compatible with other purposes" to one of the uses of open space.</li> </ul>
Plan Submittal and Review	<ul style="list-style-type: none"> <li>Ensure that stormwater management practices are specifically included in the requirement for performance bonds.</li> <li>Consider combining erosion and sediment control ordinance with post-construction stormwater ordinance.</li> </ul>
Subdivision Street Standards	<ul style="list-style-type: none"> <li>Consider allowing the use of above-ground stormwater practices in the right-of-way if part of an overall stormwater system.</li> <li>Remove curb and gutter requirement for subdivision streets if another system preferable for stormwater can be verified to be adequate.</li> </ul>
Natural Resources Inventory	<ul style="list-style-type: none"> <li>Require or provide incentives for a natural resources assessment as the initial part of the plan development review process (i.e. pre-submission/pre-application requirement for site plans, preliminary subdivision plats, etc.) and use this information in the review of proposed projects to limit the impacts on natural resources.</li> </ul>
Parking Requirements	<ul style="list-style-type: none"> <li>Reduce the size of parking stalls to 9' by 18'. Currently county code requires 10' by 20'.</li> <li>Reduce parking space minimums for commercial and office uses to 4 for every 1,000 square feet of building space. Currently county code requires 5 parking spaces for every 1,000 square feet.</li> <li>Encourage or require the use of alternative pervious surfaces for required parking/overflow parking</li> </ul>



**Stakeholder Involvement: Green Infrastructure Requirements in Atlanta**

In 2013, the City of Atlanta amended its Post-Development Stormwater Management Ordinance to require green infrastructure on new and re-development projects, including requiring runoff reduction for the first one (1) inch of rainfall. Given the significance of these changes, Atlanta City staff determined that it was critical to implement a strong stakeholder involvement and education strategy in conjunction with the proposed changes. Early in the process, staff launched numerous parallel efforts to ensure a smooth ordinance adoption, educate City leadership and future applicants, train plan review staff, prepare for compliance and enforcement, and anticipate inspection and maintenance issues. In all, it took just over a year to formalize a first draft of the proposed ordinance changes and an additional 10 months to conduct outreach, receive stakeholder input, and enact revisions prior to officially starting the legislative process.

Prior to drafting any changes to the ordinance, staff met with several prominent local engineering groups to find out which parts of the ordinance needed improvement and gain feedback on ideas that the City was interested in proposing. With this information, the Ordinance Review Team (comprised of Watershed Management and legal staff) drafted the changes and briefed other City groups that may be affected, such as Office of Planning, Office of Buildings, Department of Public Works, and the Office of Sustainability.

The City then organized a Technical Stakeholder Group consisting of civil engineers who are familiar with the City's requirements and processes, as well as non-profit organizations like the Chattahoochee Riverkeeper that advocate for clean water protection. They conducted two roundtable discussions with this group, during which they received feedback and suggestions on how the ordinance could be improved. After many of these revisions were made, they began an outreach campaign to spread the word to as

many stakeholders as possible, including development groups, environmental groups, government agencies, and many others.

The city received valuable feedback from these organizations and made several revisions prior to submitting the new ordinance to City Council. With regard to satisfying all parties involved, City staff members worked diligently to provide a balanced approach to the new requirements and were open to many of the specific changes that were suggested. While all stakeholders did not agree on all of the issues, this collaborative effort proved to be the key to gaining support from many of the groups involved.

Source: Rayburn, C., S. Rutherford. 2014. Implementing Green Infrastructure: Atlanta's Post-Development Stormwater Ordinance City of Atlanta Department of Watershed Management.

### 3.3 Better Site Design Principles

Each sub-section in Section 3.3 focuses on a specific category of BSD principles. Each section begins with a summary profile sheet that includes a brief description of the BSD principle(s) in that category and a list of the key benefits of those BSD techniques. Following each profile sheet are specific recommendations for how communities can incorporate each BSD principle into their development process. Some sections also include information on how a local government can adopt codes and/or regulations to support Better Site Design in their communities, as well as case studies to serve as examples of communities in and beyond Georgia that have successfully adopted BSD principles.

Table 3-5 provides an overview of the BSD development principles addressed in this chapter.



Table 3-5 Better Site Design Principles Discussed in Section 3.3

Section	Description
<b>3.3.1 Community Planning</b>	
3.3.1.1 Community Planning, Infill and Redevelopment	<ul style="list-style-type: none"> <li>Developing within existing urbanized areas on or between previously developed land that is currently underutilized, such as degraded parking lots or shopping centers.</li> </ul>
<b>3.3.2 Site Planning and Design</b>	
3.3.2.1 Natural Resources Inventory	<ul style="list-style-type: none"> <li>Identifying natural features and resources on a site prior to designing development layout.</li> </ul>
3.3.2.2 Conservation of Natural Features	<ul style="list-style-type: none"> <li>Strategies that can be used by local governments to enforce or provide incentives for conservation of natural features.</li> </ul>
3.3.2.3 Development Design	<ul style="list-style-type: none"> <li>Site development designs that minimize clearing and grading and emphasize use of available buildable areas in the most space-efficient way.</li> </ul>
3.3.2.4 Tree Conservation and Tree Canopy	<ul style="list-style-type: none"> <li>Local government codes that promote the preservation of trees/tree canopy cover and native vegetation during construction and post-construction phases of development.</li> </ul>
3.3.2.5 Management of Open Space, Sustainable Landscaping	<ul style="list-style-type: none"> <li>Methods to effectively manage open space and vegetation within a development.</li> </ul>
<b>3.3.3 Reducing Impervious Cover and the Development Footprint</b>	
3.3.3.1 Reducing Roadway and Right-of-Way Width and Length	<ul style="list-style-type: none"> <li>Strategies to reduce impervious cover by making streets narrower while still meeting transportation objectives.</li> </ul>
3.3.3.2 Alternative Roadway Components	<ul style="list-style-type: none"> <li>Alternatives to large cul-de-sacs and curb-and-gutter stormwater conveyance.</li> </ul>
3.3.3.3 Reducing Paved Parking and Walking Areas	<ul style="list-style-type: none"> <li>Reducing the footprint of paved parking lots, driveways, and sidewalks to reduce imperviousness.</li> </ul>
3.3.3.4 Reducing Building Footprints	<ul style="list-style-type: none"> <li>Reducing footprint size of commercial buildings and residences by using alternate or taller buildings while maintaining the same floor to area ratio (the ratio of building square footage to lot size).</li> </ul>

### 3.3.1 Community Planning

Community planning works to improve the welfare of people and their communities by creating more convenient, equitable, healthful, efficient, and attractive places for present and future generations. Infill development and redevelopment focus growth in already developed areas. Incentives, reduced fees, and required provisions are a few tools that communities can use to encourage the redevelopment of existing impervious surfaces. The following section looks at both regional and community-scale strategies that can help reduce unnecessary land disturbance and incorporate “smart growth” to create more environmentally-sound and attractive neighborhoods.

Encouraging infill development, redevelopment, and smart growth starts at both the community and regional levels. On a community level, local governments can use planning techniques including instituting an infill development/redevelopment program, reviewing and revising local codes,

and utilizing tools provided by state and federal programs to encourage these types of projects. In addition, several excellent resources mentioned in this section are geared toward local governments to help them implement these types of planning efforts.

#### 3.3.1.1 COMMUNITY PLANNING, INFILL, AND REDEVELOPMENT

**Description:** By using land more efficiently, Georgia communities can protect natural resources from development impacts while creating vibrant neighborhoods and open space for recreational activities. Encouraging infill and redevelopment is one of the best ways to use land more efficiently. **Infill development** usually refers to building on vacant parcels within existing urbanized areas already containing transportation and utility infrastructure. **Redevelopment** refers to development that occurs on previously developed land that is currently underutilized, such as degraded parking lots or shopping centers.



Figure 3.3-1 Atlantic Station – Brownfield Infill Development (Source: <http://intownbethann.com/areas/atlantic-station/>)



Figure 3.3-2 Alpharetta City Center – Redevelopment Project (Source: Alpharetta City Center)



#### KEY BENEFITS

- Preserves valuable environmental areas
- Reduces urban sprawl
- Can help reduce the amount that people drive, improving air quality and reducing greenhouse gas emissions, when it occurs near existing transit infrastructure, employment centers, and other destinations.
- Reduces costs by avoiding the need for increased infrastructure and support operations
- Incorporates “smart growth” opportunities



## CASE STUDY

### Atlantic Station, Atlanta, GA

Atlantic Station in Atlanta, Georgia offers a wonderful example of a brownfield redevelopment project. By converting an under-utilized steel mill into a mixed-use, transit-oriented community, a “live, work, play environment” was created. When the redevelopment is complete, it will consist of six million square feet of Class A office space; 3,000 to 5,000 residential units; two million square feet of retail and entertainment space, including restaurants and movie theatres; 1,000 hotel rooms; and 11 acres of public parks. Atlantic Station protected over 1,000 acres of greenfield from being developed and influenced several other neighborhood development projects (De Sousa, 2013)

### BENEFITS OF INFILL DEVELOPMENT AND RE-DEVELOPMENT

Encouraging infill development and redevelopment is one of the best ways to use land more efficiently and reduce sprawl. In general, infill development and redevelopment preserve valuable environmental areas and reduce urban sprawl since development is more compact and centered in a town or city corridor. Ultimately, costs to the community can be reduced by avoiding the need for increased infrastructure and support operations, such as fire stations, hospitals, police, and other city services in outlying areas (BMC, 2009). Infill and redevelopment also offer the opportunity to incorporate “smart growth” into the community. Smart growth refers to building urban, suburban and rural communities with housing and transportation choices near jobs, shops, and schools. This approach supports local economies and protects the environment (SGA, 2015). Some other benefits to consider are listed below.

#### Infill Development

- Can reduce development pressure on outlying areas, helping to protect lands that serve important ecological functions.
- Can reduce the amount that people drive, improving air quality and reducing greenhouse gas emissions, when it occurs near existing transit infrastructure, employment centers, and other destinations.

#### Redevelopment

- Allows a community the opportunity to bring an existing site into compliance with current stormwater requirements.
- Repurposes under-used, abandoned, and/or contaminated sites, which can improve the environment while providing multiple community benefits (DCA, 2015).
- Reduces runoff from existing properties and provides direct water quality improvements.
- Provides an opportunity to upgrade aging infrastructure, such as sewer and stormwater pipes, that are deteriorated and causing water impairments (Ellis, 2014).



Figure 3.3-3 Atlantic Station in Atlanta, Georgia

## OBSTACLES TO INFILL DEVELOPMENT AND REDEVELOPMENT

Infill development can present barriers that should be evaluated prior to moving forward with the development process. As is the case with brownfields (land previously used for industrial or commercial purposes), the expansion, redevelopment, or reuse of some sites may be complicated by the potential presence of a hazardous substance, pollutant, or contaminant (EPA, 2011). Past land use contamination should be researched and considered.

Georgia has a Brownfield Redevelopment Program that provides oversight for voluntary cleanups, a Hazardous Site Reuse and Redevelopment Act, and a Brownfields Tax Incentive Law. All of these are intended to encourage and help developers with the hurdles associated with brownfield cleanup.

In addition to site contamination, regulatory barriers such as zoning, land development regulations, and fire and building codes should be considered. Since these codes are usually written for greenfield sites, they often require more frontage, lot area, setbacks, or buffers than will fit on the typical infill lot. This can result in developers having to pursue multiple variances to develop a site (DCA, 2015).

## INSTITUTING AN INFILL DEVELOPMENT/REDEVELOPMENT PROGRAM

An effective program would include the following elements:

- Identification of areas of the community where this type of development is desired.
- Guidelines for the types of infill development / redevelopment that is appropriate for each of these areas. These guidelines will typically regulate the density, size, and architectural design of new infill development.
- Incentives to developers
- Improvements to public facilities and services to support these types of development
- Changes in existing regulations (DCA, 2015)



Figure 3.3-4 Alpharetta, Georgia is a suburb approximately 25 miles north of Atlanta. Downtown Alpharetta was lacking a pedestrian- and family-friendly environment before Alpharetta City Center was constructed. The 25-acre site consisted of city hall, small office buildings, and parking lots. Now, the site consists of a five-acre park, a Town Green area, and several pocket parks. When complete, Alpharetta City Center will be a vibrant blend of commercial, residential, and community uses.

**HOW LOCAL CODES CAN BE AMENDED TO SUPPORT THESE PRACTICES:**

**Local Level**

Local development codes often need to be revised to encourage infill development and redevelopment. Most codes are geared towards “greenfield” development rather than infill development or redevelopment. The codes that typically need to be reviewed are:

**Zoning ordinances**

- Subdivision codes
- Street standards or road design guidelines
- Parking requirements
- Minimum setback requirements
- Site coverage limits
- Height limitations
- Form-based development codes (codes based on physical form rather than use) (Hirschman, 2008)

Table 3-6 Local Code Changes to Encourage Infill and Redevelopment

Topic	Typical Local Code Conflicts	How Conflicts Can Be Resolved
Land Use Restrictions	Relying on single use districts (as with conventional zoning) to manage local land uses will prevent developers from implementing creative design ideas that involve a mix of land uses.	Add provisions for planned unit developments (refer to GQGP quality growth tool: Planned Unit Developments) or mixed-use districts (refer to GQGP quality growth tool: Mixed-Use Zoning) to your local land use regulations. See also <a href="#">Section 3.3.3.4</a> for Planned Unit Developments and other development design strategies.
Minimum Setback Requirements	Setback requirements are usually too large to fit a typical infill site.	Add a separate set of setback requirements for infill development and redevelopment projects.

Source: ARC Smart Growth Audit

Atlanta Regional Commission (ARC) Smart Growth Audit: A smart growth audit can help local governments review their growth policies and implementation measures in a systematic manner. This tool describes the concept of a smart growth audit and provides considerations and methods on how to implement a smart growth audit in your community. Although references are made to state-level and regional applications of smart growth audits, this tool focuses on how to conduct smart growth audits for local governments (ARC, 2015).



## REGIONAL LEVEL

On a regional level, the following planning techniques can be utilized to encourage infill development and redevelopment including directing growth to already developed areas, creating regional plans to identify and protect natural resources, and working with local governments to review and revise codes and ordinances.

- Direct growth to already developed areas
  - » Financial incentives and prioritized capital funding to direct growth to already developed areas or to areas targeted for development.
  - » Local government incentives, such as density bonuses and accelerated permitting processes, for infill development and redevelopment projects.
  - » Reduced impact fees for infill development based on less demand for new infrastructure.
  - » Differentiating sewer and water connection fees would allow municipalities and utility authorities to offer discounts for development in desired areas.
  - » Capital or financing from local governments for infrastructure improvements (upgrades to water, sewer, road, sidewalk, etc.) in identified growth areas.
  - » Tax Increment Financing districts to encourage redevelopment (a public-private partnership tool used to promote economic development by earmarking property tax revenue from future increases in assessed values to pay for current infrastructure development).

- » Stormwater management requirement provisions that reduce on-site management requirements for projects that decrease total imperviousness on previously developed sites, or offering off-site compliance alternative.
  - » More restrictive zoning, utility access, stormwater requirements, and other provisions outside of growth boundary or at the edge of a city to restrict development and to preserve rural character (Nevue, 2009).
- Create regional plans to identify and protect natural resources
  - Work with local governments to review and revise codes and ordinances

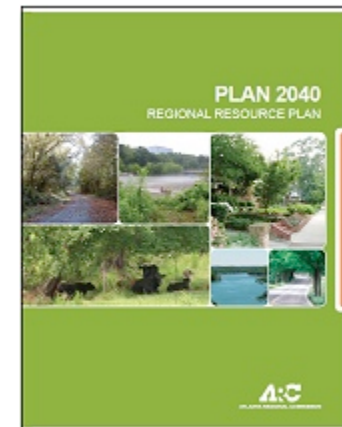

Figure 3.3-4 Pursuant to Rules of the Department of Community Affairs (DCA), the **Atlanta Regional Commission (ARC)** must prepare and adopt a Regional Plan, which includes a plan for the protection and management of regional resources and a review of activities potentially impacting these resources. In addition to the work that ARC has done with mapping the Region's Greenspace Inventory and developing a Green Infrastructure Toolkit, the Regional Resources Plan furthers the work being done on the local, regional, state and federal levels to preserve environmental resources, historic sites, and unique cultural landscapes. (ARC, 2015)

## CREATING REGIONAL PLANS TO IDENTIFY AND PROTECT NATURAL RESOURCES:

According to the rules of the Georgia Department of Community Affairs, all regional commissions in the state are required to prepare and update a “Regional Agenda. The Regional Agenda includes the region’s vision for the future as well as the strategy for achieving this vision. This gives regional commissions the opportunity to create a list of regional issues and opportunities identified for further action, an implementation program for achieving the regional vision, and an evaluation and monitoring plan to ensure the regional plan is accomplishing the desired results. For example, the Atlanta Regional Commission (ARC) has created a Regional Resource Plan that has included the following Environmental Protection Principles:

- Conserving and protecting environmentally-sensitive areas and increasing the amount and connectivity of greenspace
- Continuing to enhance stewardship of water resources throughout the region
- Promoting energy-efficient land development and infrastructure investments that foster the sustainable use of resources and minimize impacts to air quality
- Encouraging appropriate infill development, redevelopment, and adaptive reuse of the built environment to maintain the regional footprint and optimize the use of existing investments

As shown above, ARC has included infill development and redevelopment into its Regional Resource Plan. Regional commissions can use

these plans to coordinate the activities and planning efforts of local governments, land trusts, and environmental protection groups in the region (ARC, 2015).

Infill development and redevelopment can be encouraged throughout a community by local governments and regional commissions incorporating the planning techniques discussed above. By utilizing infill development and redevelopment, impacts to natural resources can be reduced by directing growth to already developed areas. Smart growth initiatives can be incorporated to create more “live, work, play” atmospheres.

## HELPFUL RESOURCES

Georgia Environmental Protection Division Brownfield website: <http://epd.georgia.gov/brownfield>

Georgia Redevelopment Fund Program: <http://www.dca.state.ga.us/communities/downtowndevelopment/programs/redevfund.asp>

Green Infrastructure Center: [www.gjicinc.org](http://www.gjicinc.org)

Smart Growth America. “What Is Smart Growth?” Smart Growth America. N.p., 2015.

U.S. Environmental Protection Agency Smart Growth Implementation Assistance website: <http://www2.epa.gov/smartgrowth/smart-growth-implementation-assistance>

U.S. Environmental Protection Agency (EPA). 2006. This is Smart Growth. Washington, D.C.

U.S. Environmental Protection Agency (EPA). 2014. *Smart Growth and Economic Success: Strategies for Local Governments*. Washington, D.C.

### 3.3.2 Site Planning and Design

The land development process can significantly alter the natural landscape by converting previously undisturbed areas into more intensive land uses. During site development vegetation and topsoil may be removed, natural drainage features may be altered, and valuable natural resources may be converted into building sites. Better site planning and design techniques seek to minimize impervious cover, conserve more natural areas, and use pervious areas more effectively to treat stormwater runoff.

The site planning and design techniques described in the following sections evaluate the footprint of a proposed development project and illustrate the relationship between proposed impervious surfaces and the existing natural conditions. The techniques place value on the environmental benefits of the natural resources at a site and incorporate protection strategies into the overall design of a project to preserve existing natural features. Protecting natural resources early in the planning process allows them to be utilized for many functions, such as infiltration, flow attenuation, groundwater recharge, flood storage, runoff reduction, nutrient cycling, air and water pollution reduction, habitat diversity, and

thermal impact reduction. In addition, some of the techniques can also have a direct positive impact on property values and provide an economic incentive to safeguard the natural features of a site before development.

The following Site Planning and Design techniques are included in Section 3.3.2:

#### 3.3.2 Site Planning and Design

3.3.2.1 Natural Resources Inventory	<ul style="list-style-type: none"> <li>Identifying natural features and resources on a site prior to designing development layout.</li> </ul>
3.3.2.2 Conservation of Natural Features	<ul style="list-style-type: none"> <li>Strategies that can be used by local governments to enforce or provide incentives for conservation of natural features.</li> </ul>
3.3.2.3 Development Design	<ul style="list-style-type: none"> <li>Site development designs that minimize clearing and grading and use available buildable areas in the most space-efficient way.</li> </ul>
3.3.2.4 Tree Conservation and Tree Canopy	<ul style="list-style-type: none"> <li>Local government codes that promote the preservation of trees/tree canopy cover and native vegetation during construction and post-construction phases of development.</li> </ul>
3.3.2.5 Management of Open Space, Sustainable Landscaping	<ul style="list-style-type: none"> <li>Methods to effectively manage open space and vegetation within a development.</li> </ul>

### 3.3.2.1 NATURAL RESOURCES INVENTORY

**Description:** The first step in the Better Site Design process is to identify existing natural features and resources that can be used in protecting water resources by reducing stormwater runoff, providing runoff storage, reducing flooding, preventing soil erosion, promoting infiltration, and removing stormwater pollutants. This can be done at the small watershed scale as part of an open space or green infrastructure plan, or at the site scale as an early step in the land development (or redevelopment) process.

Ideally, these two scales can be coordinated so that site-scale inventories are part of larger, community efforts. However, even in the absence of a larger community-wide plan, site-scale natural resources inventories are a critical part of the development process. The natural resources inventory should be completed during the site assessment phase of the overall site planning and design process. An example of a natural resources inventory map is shown in Figure 3-6. Some of the features that should be delineated in a natural resources inventory are listed in Table 3-7.

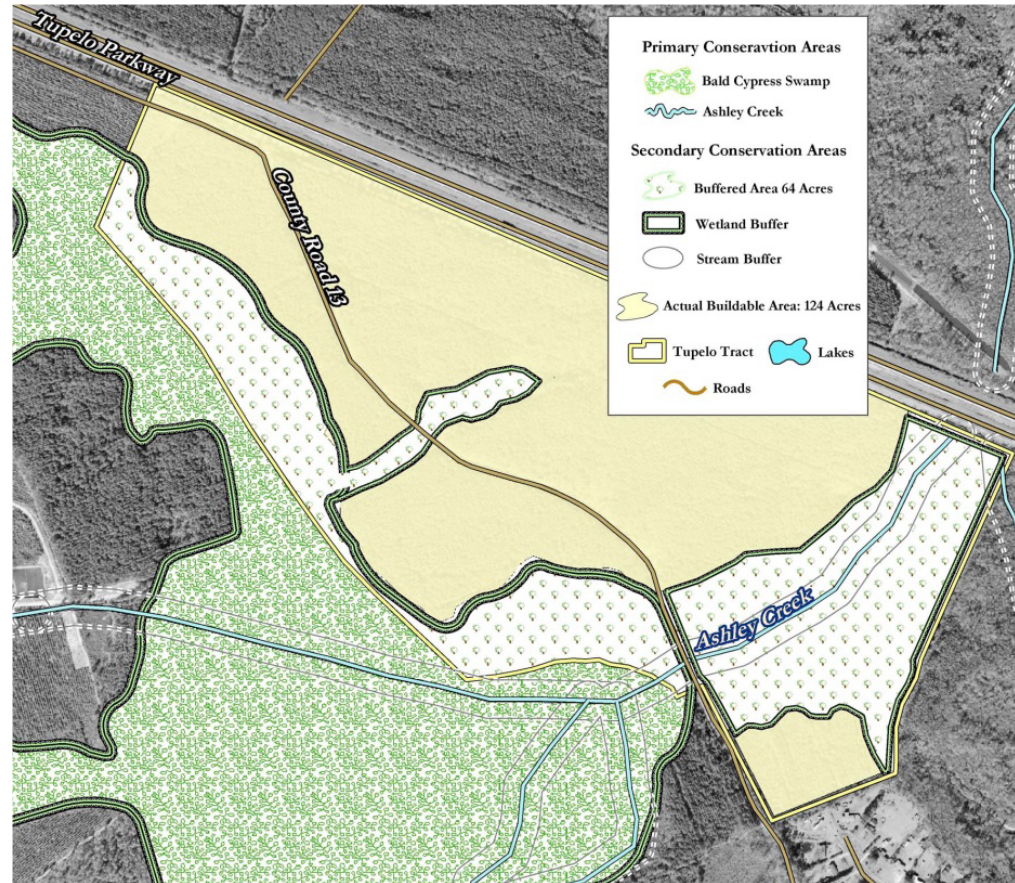

Figure 3.3-6 Delineation of Primary and Secondary Conservation Areas  
(Source: GDNr, 2006)



#### KEY BENEFITS

- Guides layout of the buildable area
- Guides creation of the stormwater management concept plan
- Serves as a basemap to accomplish other Better Site Design objectives

**SPECIFIC RECOMMENDATIONS:**

Table 3-7 makes a distinction between Primary and Secondary conservation areas. Primary areas are top priority areas for protection, and Secondary areas are landscape features that support and expand protection of the primary areas. Secondary features should also be identified in the natural resources inventory and incorporated into the site design to the extent possible.

**Mapping**

Although a lot of the information needed to complete the natural resources inventory must be gathered through site reconnaissance and surveying, some of it may be available directly from the local, state, and federal agencies, or from the Internet. In addition to local sources of data, helpful resources include:

- Georgia Department of Natural Resources, Wildlife Resources Division
- National Wetland Inventory (NWI) Maps – show the wetland geographic extent
- Wetlands-At-Risk Protection Tool (WARPT)
- U.S. Geological Survey’s National Gap Analysis Program – species ranges and distribution for conservation planning

A comprehensive list of internet sites that act as clearinghouses for Geographic Information System (GIS) data and other spatial data, along with additional information about completing a site assessment and natural resources inventory, is provided in Green Growth Guidelines (GDNR, 2006).

Table 3-7 Features to Include in Natural Resources Inventory	
Primary Conservation Areas (WRD, 2005)	Secondary Conservation Areas (GADNR, 2006)
<p><b>Aquatic Resources</b></p> <ul style="list-style-type: none"> <li>• Rivers and Streams</li> <li>• Floodplains</li> <li>• Freshwater Wetlands</li> <li>• Tidal Rivers and Creeks</li> <li>• Waterway Buffer Zones</li> </ul>	<p><b>Site Characteristics and Constraints</b></p> <ul style="list-style-type: none"> <li>• Natural Drainage Divides</li> <li>• Natural Drainage Patterns</li> <li>• Natural Drainage Features (e.g., Swales, Basins, Depressional Areas)</li> <li>• Erodible Soils</li> <li>• Steep Slopes (i.e., areas with slopes greater than 15%, or steeper in hilly or mountainous areas of the State)</li> <li>• Trees and Other Existing Vegetation (see Section 3.3.2.4)</li> </ul>
<p><b>Terrestrial Resources</b></p> <ul style="list-style-type: none"> <li>• Regionally-significant forest lands, savannas, and other unique vegetation communities, especially contiguous areas that provide habitat and wildlife corridors</li> <li>• Identified wellhead protection areas</li> </ul>	<p><b>Other Natural Resources</b></p> <ul style="list-style-type: none"> <li>• Other Groundwater Recharge Areas</li> <li>• Specimen Trees (CWP, 2009)</li> <li>• Unique natural features (CWP, 2009)</li> </ul>
<p><b>Other Natural Resources</b></p> <ul style="list-style-type: none"> <li>• Shellfishing Areas</li> <li>• High Priority Habitat Areas</li> <li>• Areas Providing Habitat for Threatened and/or Endangered Species</li> </ul>	



## HOW LOCAL REGULATIONS CAN BE AMENDED TO SUPPORT THIS PRACTICE:

In order to ensure that developers conduct a natural resources inventory prior to creating the site development design, local governments should make it a mandatory part of the development review process (as described in Table 3-8). This can be a requirement for all development plans or for discretionary reviews, such as special use permits or rezoning applications. [See Standard #1 in Section 4.2.](#)

The specific features required in the natural resources inventory should be included in the locality's plan review checklist. The natural resources inventory would be a separate engineering design sheet within the plan set listing the location of the natural resources. Pre-application meetings and plan submittal checklists can help communicate and coordinate the process. Local codes may also be revised to give the planning department or planning board the authority to require more or less protections on particular sites based on the natural resources existing on those sites.

## HELPFUL RESOURCES

Georgia Green Growth Guidelines: A Low Impact Development Strategy for Coastal Georgia: <http://coastalgadnr.org/cm/green/guide>

National Wetland Inventory (NWI) maps: <http://www.fws.gov/wetlands/>

Wetlands-At-Risk Protection Tool: <http://www.wetlandprotection.org/>

U.S. Geologic Survey's National Gap Analysis Program: <http://gapanalysis.usgs.gov/>

**Table 3-8 Example Process for Conducting a Natural Resource Inventory (CWP, 2009)**

1. Locality conducts a desktop analysis using existing GIS data: locate wetlands, floodplains, steep slopes, water bodies, etc. This provides a preliminary analysis of what is on the site and includes a jurisdictional determination and tree protection plan.
2. Developer would hire a qualified professional to conduct full field site inventory based on what was identified during desktop analysis.
3. **Optional: Locality and developer conduct a natural resources field visit.**
4. The locality field checks the completed natural resources inventory as needed.
5. The natural resources inventory would then go into the development review process.



### 3.3.2.2 CONSERVATION OF NATURAL FEATURES

**Description:** The site designer should ensure that conservation areas shown in the natural resources inventory (see [Section 3.3.2.1](#)) are protected in the development design. These features should remain undisturbed before, during, and after construction. The identification and subsequent preservation and/or restoration of these natural resources reduce the negative impacts of the land development process “by design”. This section describes strategies that can be used by local governments to enforce or provide incentives for protection of natural features designated for conservation.



Figure 3.3-7 Conservation Area in Midway, GA  
(Source: GDNR, 2006)



#### KEY BENEFITS

- Preserve priority conservation areas
- Preserve a portion of the site's natural predevelopment hydrology
- Preserve a portion of the site's natural character and aesthetic features
- Increase the value of the developed property
- Use vegetated areas as nonstructural stormwater filtering and infiltration zones
- Reduce urban heat island effect
- Improve opportunities for outdoor recreation
- Improve air quality
- Preserve wildlife habitat
- Carbon sequestration and storage

**SPECIFIC RECOMMENDATIONS:**

The conservation strategies described in Table 3-9 may require local code changes and/or changes to site plan submittal requirements for new development.

Table 3-9 Strategies for Conserving Natural Features on Development Sites

Topic	Strategy	Description
Protect Aquatic Buffers	Prohibit Development	<ul style="list-style-type: none"> <li>Prohibit development, ideally within 100 feet of streams, wetlands, and shorelines.</li> </ul>
	Specify Buffer Criteria	<ul style="list-style-type: none"> <li>Minimum buffer width</li> <li>Minimum requirements for vegetative cover</li> <li>Allowable uses of buffer area</li> <li>Re-vegetation required if vegetation currently does not exist</li> <li>Program/mechanism to inform new property owners</li> </ul>
Protect Floodplains	Prohibit Development	<ul style="list-style-type: none"> <li>Ideally, the entire 100-year floodplain should be avoided for clearing or building activities, and should be preserved in a natural undisturbed state where possible. Floodplain protection is complementary to riparian buffer preservation.</li> </ul>
Protect Steep Slopes	Avoid Grading	<ul style="list-style-type: none"> <li>Require that slopes of 15% or greater are marked on development plans and avoid excess clearing and grading of those areas. Prohibit land development activities in areas that have slopes greater than 25% unless necessary for roadway or utility construction.</li> </ul>
Protect Soils	Avoid Disturbing Erodible Soils	<ul style="list-style-type: none"> <li>Avoid grading erodible soils. Locate buildings and other impervious surfaces in areas with tight soils with the lowest infiltration rates (e.g., hydrologic soil group C and D soils).</li> </ul>
Protection During Construction	Label on Plans	<ul style="list-style-type: none"> <li>Ensure that any natural features to be protected and/or conserved are clearly delineated on clearing and grading (erosion control) plans.</li> </ul>
	On-Site Fencing	<ul style="list-style-type: none"> <li>Require that natural features to be protected and/or conserved are blocked off by temporary construction fencing prior to the start of land development activity.</li> </ul>
Zoning	Overlay Zoning	<ul style="list-style-type: none"> <li>A technique to “overlay” more protective standards over areas needing special protection. Examples are drinking water supply watersheds, wellhead protection areas, areas subject to flooding, and watersheds for critical resources, such as wetlands and special recreational areas. The overlay zone typically designates allowable land uses and performance standards for stormwater management.</li> </ul>
Legally Enforceable Instruments	Deed Restriction	<ul style="list-style-type: none"> <li>A written instrument that affects the title of a property by restricting development in perpetuity. Recorded where deeds are recorded.</li> </ul>
	Conservation Easement	<ul style="list-style-type: none"> <li>Similar to a deed restriction. Some conservation easements are set up to expire after a certain number of years, while others are designated to remain in perpetuity. Landowners with conservation easements are often eligible for tax deductions.</li> </ul>
	Maintenance Agreement	<ul style="list-style-type: none"> <li>Recorded document signed by a land-owner agreeing to protect and maintain conservation areas. These are often signed by landowners who receive cost-share funds for conservation practices.</li> </ul>

In order to make protection of on-site natural features more attractive to developers and landowners, local governments can also consider providing incentives, such as those shown in Table 3-10. Local governments that want to encourage better protection of natural resources from development may find that a combination of more stringent development rules and incentives for conservation is the most successful approach.

:

**Table 3-10 Recommended Strategies for Incentivizing Conservation of Natural Features**

Strategy	Description
Provide Stormwater Credits for Natural Area Conservation	<a href="#">Volume 2, Section 2.3</a> describes a credit that reduces the runoff reduction volume or TSS removal requirements for developments that conserve natural areas on a site.
Transfer of Development Rights (TDR)	TDR programs set up development rights markets whereby some landowners in rural or sensitive watersheds can sell their development rights to landowners in areas where growth, infill, and redevelopment are encouraged.
Purchase of Development Rights (PDR)	A program typically funded by local government that pays landowners to not convert farmland and/or sensitive natural areas to development. PDR programs are particularly targeted to areas or watersheds where rural character and natural resources should be protected.
Density Compensation	In exchange for preserving natural features in a development site plan, developers are allowed to build at a higher density. This is sometimes called Conservation Development, Cluster Development, or Open Space Development. For protecting water resources, a particular emphasis may be placed on riparian buffers, forest protection, and open space areas that capture and disperse runoff. A maximum and minimum allowable density should be established by the locality ( <a href="#">see also Section 3.3.2.3</a> ).
Permit Process Incentives	Local governments can offer incentives such as reduced permit fees, faster permit processes, and/or exemptions from permitting requirements when natural resources are protected in a development plan.
Property Tax Reduction	Landowners are charged a lower property tax rate in exchange for establishing conservation easements for sensitive natural features on their property.



## CASE STUDY

### City of Chattahoochee Hills Transfer of Development Rights Program

The City of Chattahoochee Hills, Georgia defined a goal of retaining its rural and natural character through a Comprehensive Land Use Plan. To help achieve this goal, the city adopted a transfer of development rights (TDR) ordinance to protect its rural and natural areas such as farmland and forests. Under a TDR program, properties identified as priority green space are protected. Priority green space represents the values of farmland protection, watershed protection, and cultural, historic and scenic vista protection expressed by the community. The Chattahoochee Hills Conservancy (CHC) works with property owners of identified priority green space to establish a conservation easement on their property that gives up the right to develop the land. A conservation easement is a legal document that becomes part of the deed in which the property owner pledges not to develop a defined portion of the land. In exchange, the development rights are bought by developers to increase the development density in designated growth areas to the maximum allowable density as defined in the zoning ordinance. The CHC completed two transactions to purchase TDRs as a pilot project to establish procedures. Through this pilot project, the CHC holds TDRs covering 22 acres on two parcels.

[http://www.chatthillcountry.org/dev\\_rights](http://www.chatthillcountry.org/dev_rights)



## CASE STUDY

### Forest Conservation in DeKalb County

Through the conservation efforts of the Briarlake Community Forest Alliance, a grass roots non-profit organization, the 21-acre forest at Briarlake Road and Amberwood Drive is now a community park. The wooded property, which includes at least 60 trees with trunk diameters over 30 inches (as well as many smaller trees and understory vegetation), was slated for potential development. Even with preliminary plans for a conservation development, with clustered homes on a smaller portion of the property, some believed that too much damage would be done to the forest, and the natural stormwater management benefits the forest provides would be lost. Rather than allow the land to be developed, the DeKalb County Department of Recreation, Parks, and Cultural Affairs purchased the land to create a public park and ensure that the forest would be preserved. Planning for how to manage the park, and development of a Friends of the Park organization is now underway.

<http://briarlakecommunityforest.org/>

### 3.3.2.3 DEVELOPMENT DESIGN

**Description:** In order to avoid sensitive natural features, site designers may need to use creative development designs that minimize clearing and grading and use available buildable areas in the most space-efficient way. This section describes several lot location and design techniques that allow for avoiding conservation areas. This type of development design flexibility may be a prerequisite for the implementation of the other Better Site Design strategies noted in Section 3.3.2. In essence, this and the Natural Resources Inventory (see Section 3.3.2.1) form the backbone of the site planning and design techniques.

Figure 3-8 below illustrates an example whereby development at a higher density with a space-efficient design can actually reduce overall impervious cover and disturbed area within a small watershed, as long as protection mechanisms are in place for the non-developed areas (see [Section 3.3.2.2](#)).

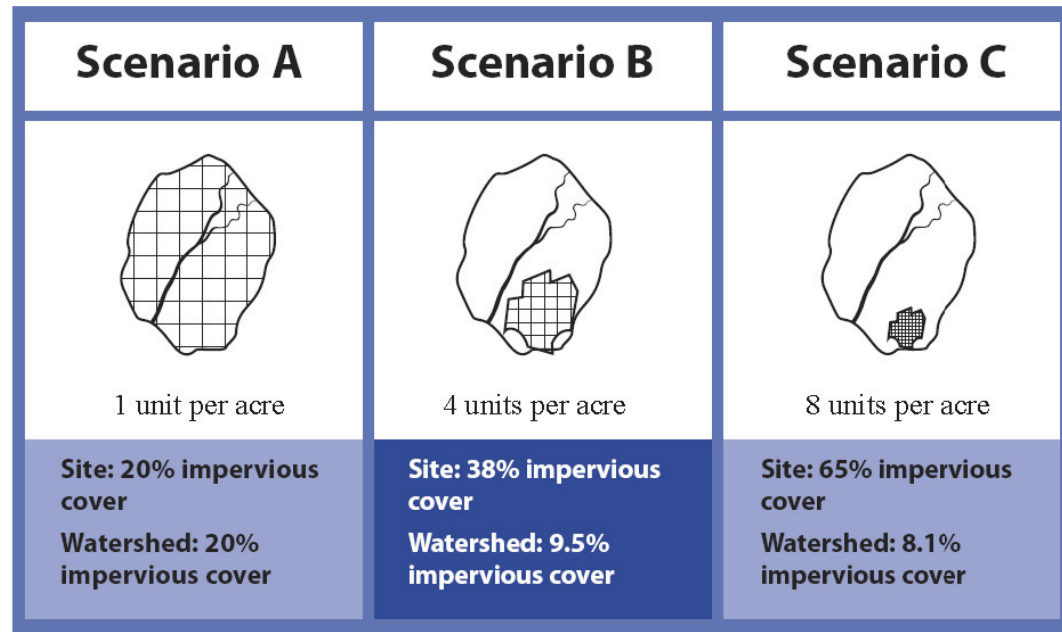

Figure 3.3-8 This illustration, adapted from the U.S. EPA publication “Protecting Water Resources with Higher Density Development”, shows how increasing density at the site level decreases impervious cover for the watershed. (Source: Ellis et al., 2014)



#### KEY BENEFITS

- Maximize land conservation while retaining same number of dwelling units as traditional lot layout
- Preserve contiguous open spaces for recreational use and/or habitat protection
- Reduce area of clearing and grading needed during construction
- Reduce sprawl
- Use vegetated areas as nonstructural stormwater filtering and infiltration zones

**SPECIFIC RECOMMENDATIONS:**

Table 3-11 Development Design Recommendations

Topic	Strategy	Description
Flexibility on Lot Size and Density	Open Space / Conservation / Cluster Development	<p>A development pattern used to concentrate structures and impervious surfaces in a small portion of a site, leaving room for larger conservation areas and managed open spaces elsewhere on the site. Smaller lot sizes and alternative lot designs are typically used to “cluster” structures and other impervious surfaces within these development projects (see Figure 3-9).</p> <p>Communities might be seeking this type of design to support walkability, transit station access, reduced infrastructure costs, and/or for water resource protection. Compact designs can be used in any development setting from ultra-urban retrofits to rural village centers. (Hirschman and Kosco, 2008)</p>
	Smaller Street Design	<p>Skinny and shorter street specifications can facilitate denser lot layouts as needed in cluster developments. Many state departments of transportation are issuing “context-sensitive” alternatives for street design that include narrow streets and consider multiple transportation modes. For transportation planners, the narrow streets are aimed at slower speeds and neighborhood design models (see also Sections 3.3.3.1 and 3.3.3.2).</p>
Lot Dimensions and Layout	Alternative Lot Dimensions	<p>Allow zipper lots, angled z-lots, and other irregular lot shapes (see Figure 3-10) in order to facilitate denser development.</p>
	Planned Unit Development (PUD)	<p>Type of development approval that allows deviations from development standards such as:</p> <ul style="list-style-type: none"> <li>• Modifying lot size and width requirements</li> <li>• Reducing building setbacks and frontages from property lines</li> <li>• Altering parking requirements</li> <li>• Increasing building height limits (see also Section 3.3.3.4)</li> </ul>
	Reduce Setbacks and Frontages	<p>Reduce front yard building setback to 20 feet to reduce the required length of driveways and sidewalks (see Figure 3-11 below). Reduce side yard setbacks to 25 feet or less and frontage length to 80 feet or less to allow for denser development and shorter road lengths.</p>



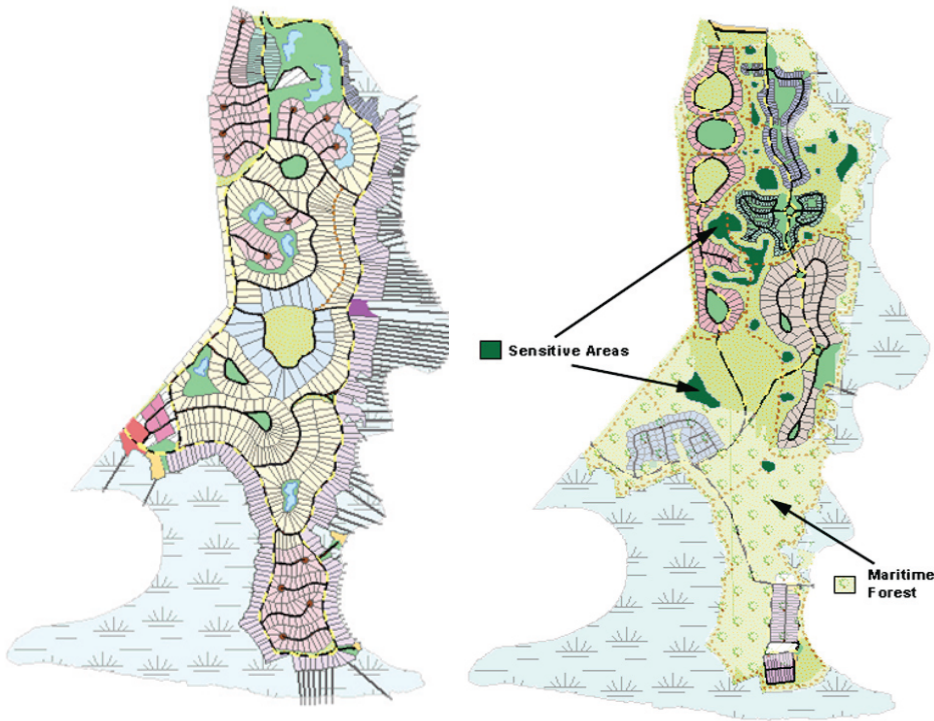

Figure 3.3-9 Conventional development with large lots throughout the site (left) vs. Conservation development style that preserves more open space (right) with the same number of lots.  
(Source: GDNR, 2006)

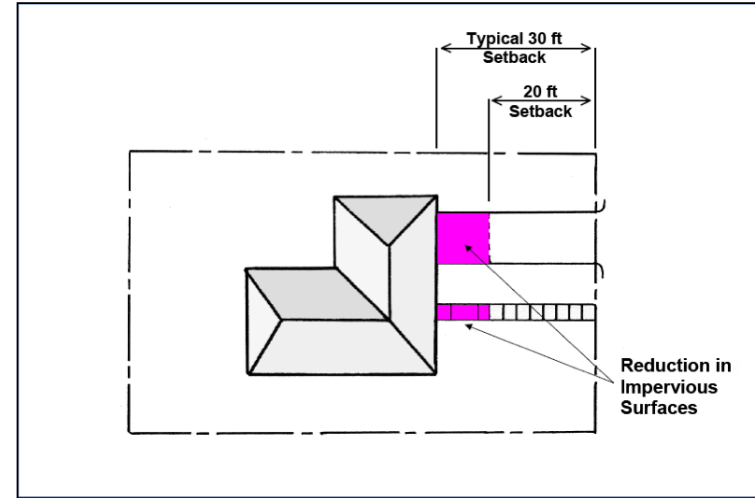

Figure 3.3-11 Reduced front yard setbacks results in the creation of less impervious cover on development sites. (Source: CWP, 1998b)

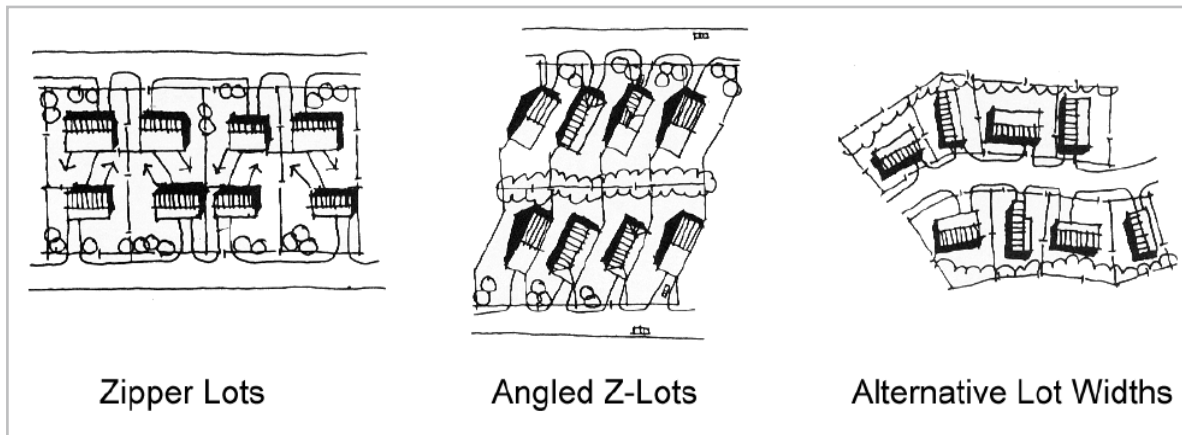

Figure 3.3-10 Alternative Lot Designs  
(Source: Center for Watershed Protection, 1998b)

### How Local Codes Can Be Amended to Support This Practice:

It is important to note that, although all of the Better Site Design techniques listed in Table 3-12 are recommended, their use may be restricted by local codes and ordinances. Therefore, until these revisions have been completed and barriers to the use of BSD techniques have been removed, developers and their site planning and design teams are encouraged to consult with the local development review authority to identify any local restrictions on the use of these techniques.

**Table 3-12 Local Code Changes to Support Alternative Development Designs**

Topic	Typical Local Code Conflicts	How Conflicts Can Be Resolved
Flexibility for development design, lot sizes, layouts, setbacks, etc.	Zoning and subdivision codes can be prescriptive to the extent that alternative designs cannot be approved. There may be “one-size-fits-all” zoning and performance standards for all zoning districts.	<ul style="list-style-type: none"> <li>Consider the big picture of how alternative development design can complement and support an open space or green infrastructure plan (see <a href="#">Section 3.3.1</a>) or broader-scale natural resources inventory.</li> <li>Consider planned unit development, transfer of development rights, and other tools for specified zoning districts to enhance density within designated growth areas, restrict impervious cover, and/or protect natural resources within rural or natural resource areas.</li> </ul>

## CASE STUDY

### Fox Hollow Development – James Island, SC

Located on James Island, South Carolina, Fox Hollow is a 2.65 acre low impact development that protected the trees, wetlands, and topography of the site. Unlike conventional development, where mass grading is common, at Fox Hollow the land has been highly conserved – only enough land for the 9 houses and roadway were cleared. Narrow streets and driveways reduce impervious cover in the development. Rather than relying on pipes, a bioswale system conveys stormwater and bioretention cells replace stormwater ponds. The site has a density of 4.22 homes/acre with 0.52 acres of open space consisting of park, bioretention and wetlands. Named “Best New Community of 2013” by the Charleston Homebuilders Association, Fox Hollow was specifically recognized for its low impact development approach (Ellis et al. 2014).

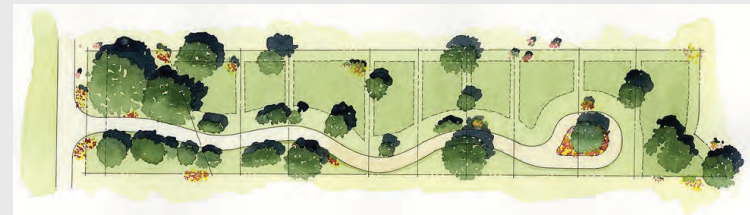

Figure 3.3-12 Site plan for Fox Hollow (Ellis et al, 2014)

### 3.3.2.4 TREE CONSERVATION AND TREE CANOPY

**Description:** Trees provide numerous well-documented benefits and are important contributors to the overall quality and viability of the environment. Trees reduce stormwater runoff through rainfall interception by the tree canopy, by releasing water into the atmosphere through evapotranspiration, by promoting infiltration of water through the soil, and by storage of water in the soil and forest litter (Figure 3-13). Georgia Forestry Commission's State of the Urban Forest Report states that infiltration rates for forested areas are 10-15 times greater than for equivalent areas of turf and grass, and a healthy forest can absorb as much as 20,000 gallons of water in an hour. The report also indicates that in Atlanta alone, the stormwater retention capacity of the urban forest is worth about \$86 million a year (Georgia Forestry Commission, 2012).

Local government codes can promote the preservation of trees and native vegetation during both the construction and post-construction phases of development. Tools that can be used for tree conservation include:

- Forest conservation ordinances
- Landmark (champion) tree preservation language in local codes
- Setting canopy goals at the site and local level
- Open space development practices
- Planting vegetation in rights-of-way and public areas
- Clearing and grading planning to protect trees at a site

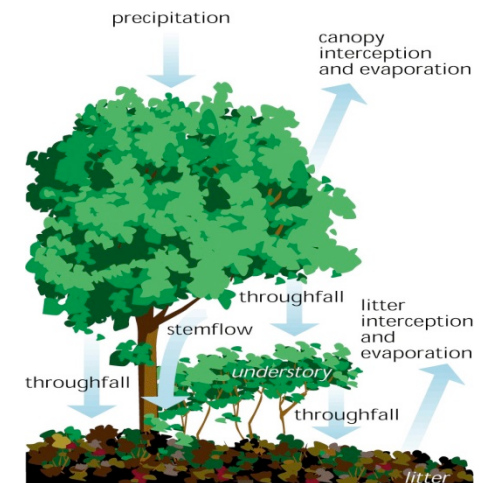

Figure 3.3-13 Schematic of a Tree's Hydrologic Cycle (Source: FISRWG)



Figure 3.3-14 Tree that Owns Itself Athens, GA (Source: Wikipedia)



#### KEY BENEFITS

- Provide reduction of stormwater runoff volume through canopy interception and water uptake
- Moderate summer air and water temperatures
- Increase value of property
- Improve regional air quality
- Reduce stream channel erosion
- Improve soil and water quality through nutrient uptake
- Provide habitat for terrestrial and aquatic wildlife
- Improve aesthetics and recreational opportunities
- Carbon sequestration and storage

**SPECIFIC RECOMMENDATIONS:**

Some of the following recommended actions for protecting trees and forest are the responsibility of the developer, while others require local government policies and action.

- Design structural elements such as roads and utilities to minimize soil disturbance and take advantage of natural drainage patterns.
- Create an inventory of landmark trees and forest preservation areas prior to developing the site plan, as part of the Natural Resources Inventory.
- Designate trees of a certain size, species, age, historical significance, ecological value, aesthetics, or location as landmark trees.
- Protect landmark trees by designating an area of no disturbance around each tree
- Promote the Site Design Credit for Natural Area Conservation (see [Volume 2, Section 2.3](#)) to encourage tree retention during site development
- Adopt a forest conservation ordinance that specifies the minimum percentage of existing forest or a tree size threshold that must be retained at a site.
- A tree replacement plan should be submitted and approved before any protected trees are removed. Protected trees that have been approved for removal should be replaced at a higher ratio of trees gained to trees lost (e.g., 3:1).
- Set minimum green space and tree canopy preservation percentages after an evaluation of existing tree resources.

- Adopt a Tree Protection Ordinance that: (1) specifies it is unlawful to remove a tree without a permit, (2) requires replacement of any removed trees that are larger than 24 inches diameter at breast height (dbh), and (3) sets a size limit to prevent certain healthy trees from being removed.
- Ensure adequate protection practices are required during site construction (such as the placement of temporary fencing around trees, and the prohibition of materials storage within the tree root zone) and that no impervious material is placed within the dripline of preserved trees.
- Consider implementing a tree point system to evaluate site plans and ensure that both the number of trees and the quality of the trees for each site are assessed. See the City of Savannah's Landscape and Tree Ordinance Compliance Manual for an example point system.

**How Local Codes Can Be Amended to Support This Practice:**

Local governments play an important role in protecting forests during and after construction by ensuring that appropriate ordinances are enforced to adequately protect trees and forest areas. Many of the actions recommended above require additions or revisions to local codes and ordinances. Table 3-13 lists several code changes that communities can make if their codes are currently "silent" on or in conflict with tree and forest protection.

**Table 3-13 Local Code Changes to Encourage Tree Conservation and Planting**

Topic	Typical Local Code Conflicts	How Conflicts Can Be Resolved
Forest/Tree Conservation	No codes exist promoting tree retention during site development	Adopt a Forest/Tree Conservation Ordinance in local land development regulations that specifically addresses the link between a functional landscape and the protection of trees at a site
Landmark Trees	No protection is afforded to trees of significant value	Establish criteria in the ordinance (or accompanying regulations) for size, age, and/or type of trees that must receive special protection. Define penalties associated with unauthorized damage or removal of an individual tree that meets the criteria.
Landscaping requirements	Landscaping code does not specify the type of vegetation to be used or does not allow for adequate spacing of trees	Landscape ordinances can provide guidance on: number of trees per parking space; species selection; plant spacing; setbacks from buildings, pavement, and utilities; planting plan development; and maintenance schedules.

 **CASE STUDY**

**Oak Terrace Preserve, North Charleston, SC**

Oak Terrace Preserve is a 55-acre sustainable redevelopment project located in Park Circle, North Charleston. The redevelopment project provided green sustainable features in home construction in addition to pocket parks, public space, an LID stormwater management system, and an extensive tree preservation program. An important aspect incorporated into the project was the protection of its tree resources. Prior to development, Oak Terrace Preserve was home to over 600 trees, many of them grand trees with 24-inch or larger diameters, including oaks, magnolias, and additional old-growth trees that are rarely found in a new community. Tree preservation and management was a top priority. A certified arborist performed a tree survey and assessment before construction. During site construction activities, fencing protected the trees and their critical root zone. The certified arborist’s continued involvement on-site was a major factor for successful tree protection



**Figure 3.3-15** One of the mature oak trees protected in Oak Terrace Preserve



### 3.3.2.5 MANAGEMENT OF OPEN SPACE, SUSTAINABLE LANDSCAPING

**Description:** Development that encourages open space design also has an opportunity to use that open space to help manage stormwater and reduce runoff. The retention of open space in a natural condition (i.e., native vegetation) helps to infiltrate rainfall, thereby reducing runoff volume and the need for structural stormwater practices at a development site.

Communities should also explore reliable methods to assure that the responsibility for open space management can be met within a development. The two primary options are to create a community association (with an annual assessment to property owners for management purposes) or to shift the responsibility to a third party, such as a land trust or park authority, by means of a conservation easement. The latter technique is especially useful in developments that have high quality conservation areas retained in open space.



#### KEY BENEFITS

- More effective treatment of stormwater
- Open space managed in natural condition has a reduced annual maintenance cost
- Reduced demand for irrigation and use of potable water supplies
- Fewer chemical inputs and less pollution in runoff.
- Improve site aesthetics which may result in higher property values
- Carbon sequestration
- Reduce urban heat island
- Improve recreational opportunities



Figure 3.3-16 EcoScapes Sustainable Landscaping Demonstration Garden at UGA Marex Brunswick Station  
(Source: University of Georgia)



**SPECIFIC RECOMMENDATIONS:**

When existing open space and natural landscaping areas are designated for permanent protection on a development plan, it is important to ensure that they will remain intact and functional for the long-term. This requires assurances that they will not be impacted for future development and that they will be maintained properly. The following list includes recommended methods to establish long-term designation and management of such open spaces.

- Ensure that consolidation of open space is maximized to provide the largest natural areas possible.
- Spell out allowable uses for open space areas in local codes or maintenance agreements.
- Require that a minimum percentage of the open space be managed in an undisturbed natural condition, preferably with low-maintenance native vegetation. The University of Georgia Cooperative Extension has guidance on native landscaping appropriate for a site.
- Prohibit the installation of any plant species that is listed as an invasive species by the Georgia Invasive Species Task Force.
- Establish limits for lawn areas in favor of other natural groundcovers or vegetation.
- Be sure to have a reliable method for ensuring management of open space through enforceable requirements to establish associations that can effectively manage open space.
- Provide assistance to developers and/or real estate agents to develop and transfer information to homebuyers and homeowners' associations concerning maintenance of on-site water quality practices, the purpose of stormwater management facilities, proper management of conservation areas, etc.
- Identify and document existing stream buffers, forest conservation areas, and other natural features that may be located in designated open space areas. Use signage as a communication tool about the open space areas and protection objectives (signs reading "designated for protection", "do not dump yard waste or litter", etc.).
- Landscaping should be designed to remain functional and attractive during all seasons of the year through a thoughtful selection of deciduous, evergreen, flowering, and non-flowering plant varieties.
- Prominent natural features of the landscape, such as mature trees and surface waters, should be retained and incorporated into the landscape plan where possible.
- LEED Standards (Leadership in Energy and Environmental Design) for new construction call for outdoor space greater than or equal to 30% of the total site area (including building footprint). A minimum of 25% of that outdoor space must be vegetated or have an overhead vegetated canopy. Turf grass does not count as vegetation.

**Sustainable Landscaping**

In addition to preserving existing open spaces, developments have an opportunity to establish new areas of vegetation and habitat. There are many factors to consider when creating a sustainable, low impact landscape. The Sustainable Sites Initiative, a collaborative project of the American Society of Landscape Architects, Lady Bird Johnson Wildflower Center, and the United States Botanic Garden, seeks to establish and encourage sustainable practices in landscape design, construction, operations, and maintenance. The following table describes some design, construction, and maintenance factors to assess the sustainability of a landscape design.

Table 3-14 Summary of Sustainable Landscaping Practices\*

Criteria	Suggested Landscaping Practices
Site Selection	<ul style="list-style-type: none"> <li>• Protect floodplain functions</li> <li>• Preserve wetlands</li> <li>• Preserve threatened or endangered species and their habitats</li> <li>• Select brownfields or other vacant properties for redevelopment</li> <li>• Select sites within existing communities</li> <li>• Maintain natural, undisturbed areas</li> </ul>
Site Design – Water	<ul style="list-style-type: none"> <li>• Control and manage known invasive plants found on site</li> <li>• Use appropriate, non-invasive plants and native plants</li> <li>• Create a soil management plan</li> <li>• Minimize soil disturbance in design and construction</li> <li>• Preserve or restore appropriate plant biomass on site</li> <li>• Preserve or restore appropriate plant communities native to the ecoregion</li> <li>• Use vegetation to minimize building heating and cooling requirements</li> <li>• Reduce urban heat island effects</li> <li>• Reduce the risk of catastrophic wildfire</li> </ul>
Site Design – Materials Selection	<ul style="list-style-type: none"> <li>• Reuse salvaged materials and plants</li> <li>• Use recycled content materials</li> <li>• Use regional materials</li> <li>• Support sustainable practices in plant production and materials manufacturing</li> </ul>
Site Design – Human Health and Well-Being	<ul style="list-style-type: none"> <li>• Protect and maintain unique natural, cultural, and historical places, such as shell rings, Carolina bays, tabby structures, and cemeteries</li> <li>• Provide views of vegetation and outdoor spaces for mental restoration</li> </ul>
Construction	<ul style="list-style-type: none"> <li>• Restore soils damaged by previous development</li> <li>• Reuse or recycle vegetation, rocks, and soil generated during construction</li> </ul>
Operations and Maintenance	<ul style="list-style-type: none"> <li>• Compost organic matter generated during site operations and maintenance</li> </ul>

\*Adapted from the Sustainable Sites Guidelines and Performance Benchmarks, 2009

**How Local Codes Can Be Amended to Support This Practice:**

Local development codes should ensure that open space is well planned and that clear performance criteria for open space consolidation, maintenance, allowable uses, and future management are carefully crafted. This includes ensuring that common open space and natural conservation areas are managed by a responsible party able to maintain the areas in a natural state, in perpetuity. Typically, the conservation areas are protected by legally enforceable deed restrictions, conservation easements, and maintenance agreements. Management of open space areas can be taken on by a Homeowner Association or a local land trust, for example, to monitor the site and enforce its boundaries. The option to designate maintenance should be specifically allowed in local ordinances.



**CASE STUDY**

**Sustainable Landscape Management Policy – DeKalb County, GA**

DeKalb County’s Sustainable Landscape Management Policy endorses environmentally responsible and sustainable landscaping management practices for the protection of the county’s water supply and the enjoyment of these resources by DeKalb residents. All newly constructed and existing county facilities and grounds employ sustainable landscaping practices including the use of drought tolerant, locally-adapted plants and the use of Integrated Pest Management (IPM).

**Table 3-15 Local Code Changes to Support Management of Open Space**

Topic	Typical Local Code Conflicts	How Conflicts Can Be Resolved
Sustainable Landscaping	The use of alternate landscaping practices can actually be restricted by current planting requirements in ordinances	Communities should develop and adopt a Sustainable Landscaping section in their land development regulations that specifically addresses the link between a functional landscape and the protection of water resource quality, which spells out requirements and objectives based on land use type and activity.
Definitions of Open Space	Code is “silent” on what can be officially designated as open space on a development plan	Specify the types of features that can (e.g., stream buffers, contiguous forest, floodplains) and cannot (e.g., lawn) be designated as open space. This is especially important for developments that are given special credit for preserving open space.
Allowable Uses of Open Spaces	Acceptable uses for open space areas are not defined in local codes and may prevent efforts to address runoff	Add definitions for eligible and ineligible uses for open space areas (e.g., recreation).

### 3.3.3 Reducing Impervious Cover and the Development Footprint

Impervious surfaces like asphalt and concrete generate the greatest amount of stormwater runoff, and the pollutant loads are higher coming off impervious surfaces than pervious surfaces like lawns or other vegetated areas. Designing development and redevelopment with the goal of minimizing pavement and building surfaces is an excellent way to mitigate runoff and promote healthy waterways. The design is heavily influenced by municipal ordinances.

The policy guidelines here are generally recommended, but it is important to recognize that individual circumstances may not support application of these tenets. For example, fire code and fire engine access requirements influence roadway design and will take priority over recommendations guided by Better Site Design where there is conflict. To minimize potential conflicts and foster mutual understanding and agreement, stakeholder roundtable discussions are highly recommended; often long-standing concepts can be reexamined and new, progressive, purposeful consensus can be achieved ([see Section 3.2](#)).

Much of the information presented here is adapted or taken from the National Association of City Transportation Officials (NACTO) and their Urban Street Design Guide (NACTO, 2015), the collected works of the American Association of State Highway and Transportation Officials (AASHTO), primarily A Policy on Geometric Design of High-

ways and Streets (AASHTO, 2004), and the Center for Watershed Protection's Better Site Design: A Handbook for Changing Development Rules in Your Community (CWP, 1998b).

#### The role of local government

A local government's codes and regulations can guide development and transportation design in such a way that the volume of stormwater runoff is reduced and water quality is improved. This also serves other community goals, such as economic development, safety, aesthetics, and land use objectives. Reducing impervious cover can also reduce the urban heat island effect, and may result in lower construction and maintenance costs.

The following Better Site Design techniques for reducing impervious surfaces are included in Section 3.3.3:

#### 3.3.3 Reducing Impervious Cover and the Development Footprint

- |  |  |
|--|--|
| 3.3.3.1 Reducing Roadway and Right-of-Way Width and Length | 1. Strategies to reduce impervious cover by making streets narrower while still meeting transportation objectives.                                       |
| 3.3.3.2 Alternative Roadway Components                     | 2. Alternatives to large cul-de-sacs and curb-and-gutter stormwater conveyance.  |
| 3.3.3.3 Reducing Paved Parking and Walking Areas           | 3. Reducing the footprint of paved parking lots, driveways, and sidewalks to reduce imperviousness.  |
| 3.3.3.4 Reducing Building Footprints                       | 4. Reducing footprint size of commercial buildings and residences by using alternate or taller buildings while maintaining the same floor to area ratio. |

### 3.3.3.1 REDUCING ROADWAY AND RIGHT-OF-WAY WIDTH AND LENGTH

**Description:** One of the more obvious ways to reduce impervious cover is to make streets narrower and shorter, while still meeting transportation objectives. “Skinny” streets have many benefits, not only for reducing runoff, but to enhance aesthetics, safety, pedestrian orientation, and neighborhood character. Communities that have adopted skinny street practices have found that while there are policy issues and obstacles to navigate, most can be resolved with a focus on stakeholder input and a clear vision.



Figure 3.3-17 Narrow streets reduce impervious cover area.



#### KEY BENEFITS

- Less stormwater runoff
- Lower flow velocities (less erosion potential)
- Less expensive to construct and maintain roads
- Safer (due to lower speeds)
- Lower heat island effect

**SPECIFIC RECOMMENDATIONS:**

Table 3-16 shows recommended street widths based on the volume of traffic and parking needs expected for a given street. The acronym "AADT" stands for annual average daily traffic, a common method in transportation planning of measuring expected vehicle use and designing roads based on that level of traffic. If the designer knows the number of residences served by a street, but not AADT, a general rule is 10 AADT per household, though this number may be lower depending on other transportation modes available and general connectivity of the area.

Width	Condition
10-12'	Residential access alley (no parking)
18-20'	Up to 400 AADT, parking/queueing one side Up to 1000 AADT, no parking
26-28'	Up to 400 AADT, parking/queueing on both sides Up to 1000 AADT with parking on one side (two lanes, no queueing necessary)

Note: Street width options are influenced by housing density and need for on-street parking, and may vary. These are recommended widths, prioritizing reduction of impervious surfaces.

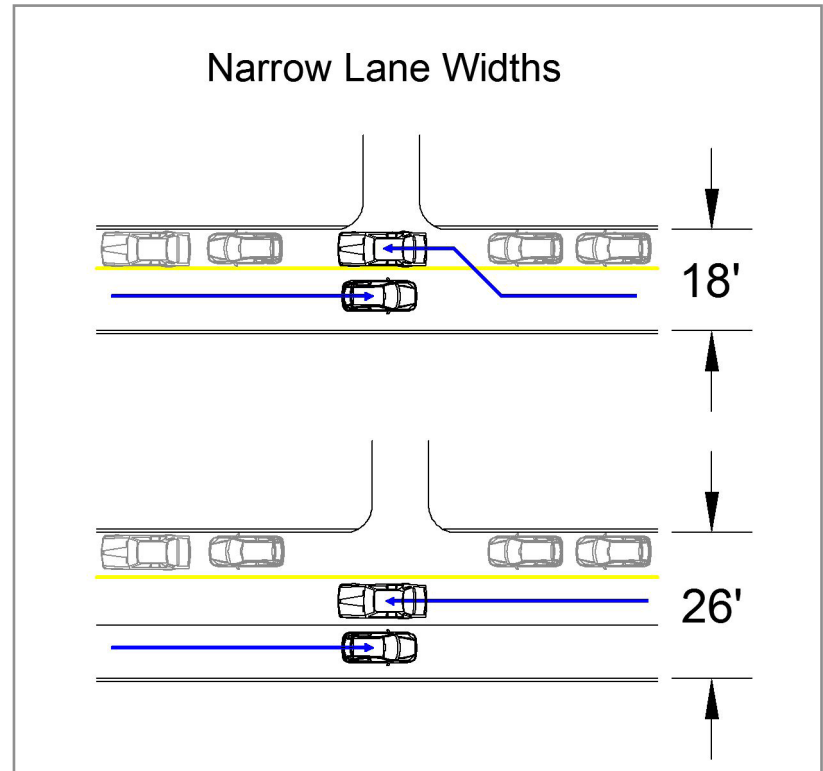

Figure 3.3-18 Examples of narrow road configurations. Top: one drive lane and one parking/queueing lane; Bottom: two drive lanes and one parking lane



**Table 3-17 Considerations for Narrow Streets (CWP, 1998b)**

- Maximum vehicle width is 8.5' per USDOT. Note: this is the body width, exclusive of rear-view mirrors, etc.
- Roadway can be as narrow as 18' wide with parking on one side\* and still pass fire engines or other emergency vehicles. This is a 7' parking/queueing lane, and 11' drive lane. \*Travel in both directions requires occasional queueing, where one vehicle pulls to the side to allow another to pass in the opposite direction.
- Roadway can be as narrow as 26' wide to have parking and traffic queueing on both sides.
- The slight increase in accident risk associated with narrower drive lanes is easily offset by the associated lower risk and severity due to a slight reduction in speed limit.
- Most vehicles are significantly narrower than 8.5'.

[Example: Connecticut Avenue through Chevy Chase, MD (inside the Washington, D.C. Capital Beltway) has 8' lane widths on a 6-lane road with AADT counts between 35,000 and 50,000. The speed limit was lowered slightly (to 30 mph) to account for the narrower road width, and the presence of multiple lanes and median strip allows an oversized vehicle to traverse the road if and when necessary.]

Table 3-18 provides lane width guidance from the American Association of State Highway and Transportation Officials (AASHTO), based on the type of roadway and geographic location

**Table 3-18 Acceptable Lane Widths for Various Roadway Types (AASHTO, 2004)**

Type of Roadway	Rural		Urban	
	Feet	Meters	Feet	Meters
Freeway	12	3.6	12	3.6
Ramps (1-lane)	12-30	3.6-9.2	12-30	3.6-9.2
Arterial	11-12	3.3-.3.6	10-12	3.0-3.6
Collector	10-12	3.0-3.6	10-12	3.0-3.6
Local	9-12	2.7-3.6	9-12	2.7-3.6

Many agencies are hesitant to allow narrower streets, due to various safety and logistical concerns. Table 3-19 addresses some of the common concerns about narrow roadways and some facts that may help to relieve those concerns.

**Table 3-19 Perceptions vs. Realities about Narrow Streets (CWP, 1998b)**

Perception	Reality
Narrow streets interfere with the ability to clear and stockpile snow.	<p><b>FACT:</b> “Narrow” snowplows are available. Snowplows with 8’ width, mounted on a pick-up truck are common. Some companies manufacture alternative plows on small “Bobcat” type machines.</p> <p><b>FACT:</b> Snow stockpiles on narrow streets can be accommodated if parking is restricted to one side of the street.</p>
Narrow streets will cause traffic congestion.	<p><b>FACT:</b> Narrow streets are generally appropriate only in residential areas that experience less than 500 AADT. Design criteria based on volume generally provide safe and efficient access in residential areas.</p>
Narrow streets do not provide enough room for on-street parking.	<p><b>FACT:</b> Parking can be accommodated through the use of queuing streets with only one travel lane.</p> <p><b>FACT:</b> Most communities require some off-street parking accommodation in residential subdivisions. Olympia, Washington requires two parking spaces per dwelling unit. On-street parking is used for visitor parking or other vehicles, such as boats.</p>
Narrow streets can cause pedestrian/vehicle accidents.	<p><b>FACT:</b> In a study of over five thousand pedestrian and bicycle crashes, a narrow roadway was a factor in only two cases. Unsafe driving speed, on the other hand, contributed to 225 accidents.</p> <p><b>FACT:</b> Narrower street widths reduce the speed at which vehicles can drive, which reduces the severity of pedestrian/vehicle accidents.</p>
Narrow streets do not provide access for maintenance and service vehicles.	<p><b>FACT:</b> Trash trucks require only a 10.5’ travel lane, with a standard truck width of approximately 9’. In residential neighborhoods, trash collection often occurs simultaneously on both sides of the street; cars must wait for trash trucks to pass regardless of street width.</p> <p><b>FACT:</b> Half ton mail trucks, smaller than many privately owned vehicles, are generally used in residential neighborhoods. Hand delivery of mail or single point of mail delivery for multiple houses is also an option.</p> <p><b>CASE STUDY:</b> School buses are typically eight feet wide (nine feet from mirror to mirror). Both Prince Georges County and Montgomery County, MD require only a 12’ driving lane for bus access. Furthermore, school buses usually do not drive down every street, but instead meet children at bus stops on larger roads.</p>

### Reducing Right-of-Way Width

A complementary strategy for narrow streets is to reduce the width of the overall right-of-way (ROW). The right-of-way is the total land area that contains all of the cross-sectional features of the roadway, including pavement width, curbing, buffers, sidewalks, utilities, drainage, and grading (RI DEM and CRMC, 2011).

- The ROW width affects many stormwater-related conditions.
- Reducing the ROW width can reduce the area of vegetation that must be cleared regularly, thereby preserving existing trees and reducing the impact on water resources.

The Institute of Transportation Engineers (ITE) guidelines recommend a minimum ROW width of 50 feet for low density development and 60 feet for medium and high-density developments (ITE, 1997). Therefore, ROWs between 50 and 60 feet in width are common. However, the standard 50 to 60 foot width can be excessive in many situations. While a wide ROW does not necessarily create more impervious cover, it can work against Better Site Design principles. The wider ROW subjects a greater area to clearing and grading during road construction, and also consumes land that could be used for development. The ROW should only be wide enough to contain the necessary elements as shown in Figure 3-19. Generally, widths of 24 to 52 feet are sufficient (Ellis, 2014)

### How Local Codes Can Be Amended to Support This Practice:

Rather than writing codes to establish minimum widths under certain conditions, establishing maximum widths that can be overridden only with special exceptions or circumstances will help achieve lower impervious area quantities in new development scenarios. National codes and standards actually allow somewhat surprising reductions compared to what is normally seen. For example, the U.S. Fire Administration allows a road as narrow as 18' wide, while many low-volume residential streets are 24-36' wide or wider.

For best stormwater runoff conditions, require designs to use the minimum required width to accommodate travel, parking, and emergency, maintenance and service vehicles – based on annual average daily trips (AADT).

Figure 3.3-19 Right-of-way cross sections. Both roadways have a 50-ft ROW. The top cross-section shows how a typical road produces excessive impervious cover with 26 feet of pavement and sidewalks on both sides of the street. The bottom cross section demonstrates a design with roadside swales, narrower travel lanes, and a single sidewalk (Source: Center for Watershed Protection).

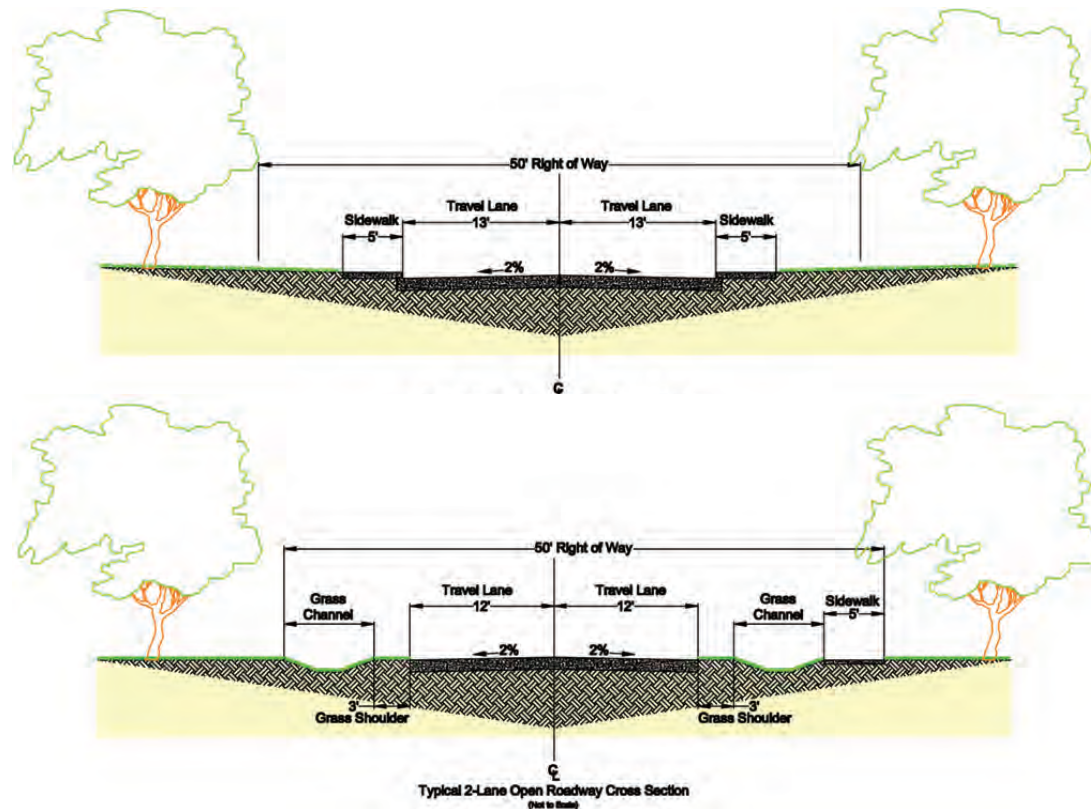



## CASE STUDY

### Conservation Incentive: Laurel Oak Grove, James Island, SC (Ellis et al, 2014)

Laurel Oak Grove was successfully able to integrate several Better Site Design techniques and LEED certification into affordable housing. When complete, Laurel Oak Grove will have 22 houses (13 in Phase I and 9 in Phase 2) situated on 6.3 acres with approximately half of the property in preserved open space. The basis of the site design is clusters of houses at a higher density surrounding communal features, such as courtyards. The City of Charleston has a special zoning ordinance for this type of development for the purpose of “permitting unique developments that utilize flexible design that is sensitive to natural areas, provides quality open space, decreases stormwater runoff by reducing impervious surfaces, reduces the cost of infrastructure, and provides a mixture of lot sizes and housing options.” Homeowner association dues will be used to pay for maintenance of common areas, but homeowners also receive 20 hours of educational classes about the green features of their homes and landscapes.

In addition to high density lots and conserved open space, the site also minimizes impervious surfaces. The 3-ft wide sidewalks are narrower

than the typical 5-ft widths. Houses do not have individual driveways; parking is situated along the perimeter of the roadway. The parking spaces are gravel, and are limited to two per house. The asphalt road allows for resident access to parking and houses on one side of the property; a gated, gravel access road for utilities and emergency vehicles was provided on the back side.

The soils on site have a high infiltration rate, allowing for shallow infiltration basins and perforated underdrains as the main components of the stormwater management system. The narrow (20' wide) asphalt roadways are bordered by flat ribbon curbs, which allow stormwater to flow to pervious gravel parking areas. Gravel trenches and perforated underdrain pipes are underneath the gravel parking areas so that stormwater runoff will flow through the rock, into the underdrain, and into the infiltration basins. Under saturated soil conditions, the water passes from the infiltration basins into overflow catch basins and into an underground piping system that discharges into low lying, undeveloped areas of the property. The infiltration basins serve a secondary purpose as attractive, vegetated common space features for the homeowners and are centrally located.



Figure 3.3-20 Laurel Oak Grove Road Narrowing Plan.

### 3.3.3.2 ALTERNATIVE ROADWAY COMPONENTS

**Description:** Cul-de-sacs in residential areas account for a significant amount of impervious area and typically serve small numbers of homes. Using different configurations for turnarounds can reduce this contribution greatly. Either landscaping to the extent practical, or replacing the traditional cul-de-sac with something else, will help achieve the benefits associated with lower impervious areas. Similar to a center island in a cul-de-sac, longitudinal landscaped islands along roadways can reduce stormwater runoff and improve treatment, and often make great locations for tree pits or grass swales.

Standard curb-and-gutter systems serve a few purposes: acting as safety measures, helping to keep vehicles from running off the road, and conveying stormwater runoff directly into storm sewers. As an alternative to traditional curb-and-gutter, open drainage channels (e.g., grass swales, dry swales) both reduce volumes and flow rates, while also treating runoff and improving water quality.



Figure 3.3-21 Cul-de-sac with vegetated island (left) and narrow road with grass swale (right).



#### KEY BENEFITS

- More attractive
- Less stormwater runoff
- Lower flow velocities (less erosion potential)
- Less expensive to construct and maintain
- Lower heat island effect



## SPECIFIC RECOMMENDATIONS

### Reducing Right-of-Way Width Cul-De-Sacs and Turn-Arounds

Residential neighborhood road layouts often require some form of turn-around. A cul-de-sac is the most prevalent type of turn-around, and usually takes the form of a large, round, paved area. Although they most often serve only a small number of homes, cul-de-sacs tend to be exceedingly large. Alternatives to the large bulb (such as those shown in Figure 3-22 and Table 3-20) can greatly reduce impervious area, provide adequate access for vehicles, and be much more visually appealing.

One option for the cul-de-sac of standard size is to add a center island as a sunken stormwater practice (Option 1 in Figure 3-22). By grading the cul-de-sac toward the center rather than the edges, a center island with a bioretention basin can collect runoff and reduce the need for curb and gutter (see next section on curb and gutter). As shown in Figure 3-23, the bioretention must have an underdrain and/or overflow connected to the storm drain infrastructure, otherwise excessive ponding may cause a hazardous condition on the road (see detailed specifications in [Volume 2, Section 4.2](#)).

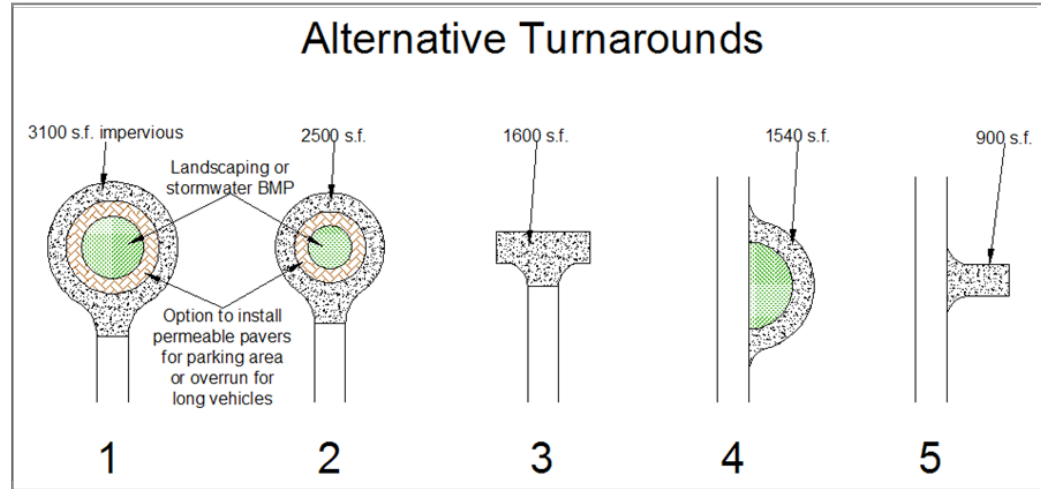

Figure 3.3-22 Alternative turn-around options, and their approximate impervious surface areas

Table 3-20 Impervious Area Associated with Various Turn-Around Options.

Option	Impervious area, as drawn
1. 42' radius cul-de-sac, with landscaped island and pervious paver parking/overhang lane	3100 square feet
2. 35' radius cul-de-sac, w/island and pervious lane	2500 square feet
3. "Tee" or "Hammerhead" turn-around	1600 square feet
4. Loop road	1540 square feet
5. "L" alternative to hammerhead	900 square feet



Smaller cul-de-sacs, such as Option 2 in Figure 3-22, may be an issue for emergency/service vehicles. The AASHTO design vehicle single-unit truck has a minimum design turning radius of 42', and a minimum inside radius of 28.3' (AASHTO, 2004). Pump truck fire engines and ambulances fall into this category. While many of these vehicles will have smaller turning radii, the "least common denominator" is the generic design vehicle. The fire marshal may have an overriding standard necessitating a larger diameter cul-de-sac. If so, it is recommended to have a discourse to determine the extent to which the center island and pervious lane can be implemented.

Round cul-de-sacs are popular turn-arounds in residential developments, but alternatives potentially create less impervious area. Tee-shaped turn-arounds, also known as "hammerheads" (Option 3), are especially suitable for short streets and require only a moderate amount of pavement area. Loop roads (Option 4) work well where there is a place for a wider right-of-way, but still use less impervious area than a cul-de-sac. The L-shaped turnaround (Option 5) works similarly to a hammerhead, but requires the least amount of pavement out of all the options.

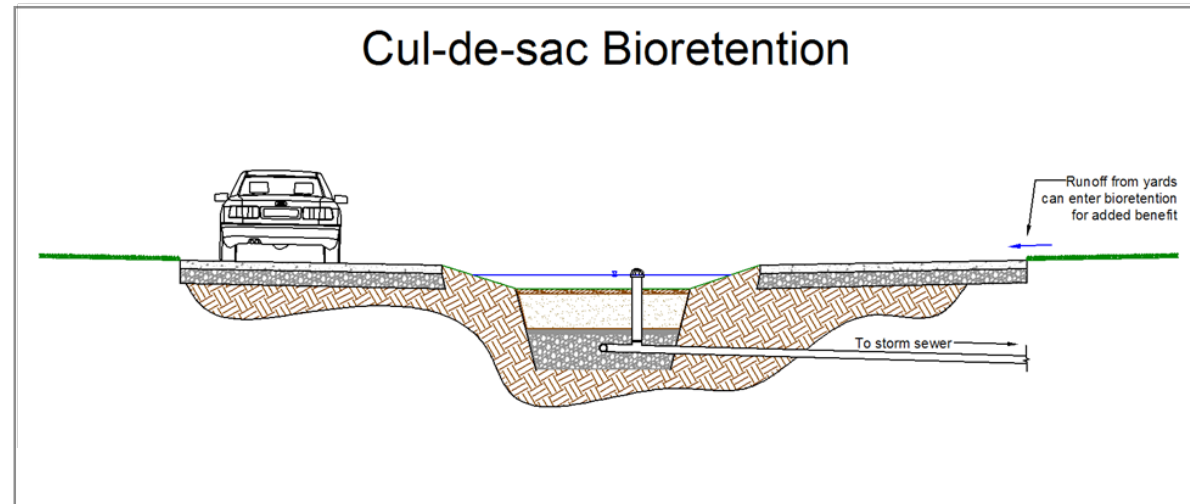

Figure 3.3-23 Bioretention option for cul-de-sac center "island". These can capture runoff from the cul-de-sac and adjacent yards, but must have an overflow device connected to a storm sewer or other outfall.



Figure 3.3-24 Cul-de-sac bioretention at E. Rivers Elementary School in Atlanta.

### Curb and Gutter Stormwater Conveyance

The traditional curb-and-gutter system is space-efficient, but only functions to convey stormwater away from roads. In contrast, grass channels, swales, and other vegetated stormwater conveyances (Figure 3-25) built alongside streets or in medians provide several functions simultaneously:

- Stormwater conveyance
- Stormwater treatment
- Impervious area reduction (as compared to curb and gutter)
- Act as a shoulder when necessary for emergency vehicles or parking

### How Local Codes Can Be Amended to Support These Practices:

Local governments can make changes to street design specifications and codes in order to allow and encourage the use of turnarounds that create less impervious area and the use of vegetated conveyances that provide more treatment of stormwater. Many communities have local design codes that require the use of round cul-de-sacs and curb-and-gutter. Therefore, the first code changes needed are those that provide flexibility to developers on these requirements. Local design codes can also set maximum sizes for cul-de-sacs, based on the number of homes served, as a way to avoid the creation of excessively large cul-de-sacs. Rebates or other incentives for retrofitting already-built cul-de-sacs and roads can reduce existing impervious area.

Establishing these codes in collaboration with other stakeholders will likely require deliberation with a variety of agencies and groups. The local fire marshal's office, for example, usually has specific guidelines governing vehicle access requirements. Discussions between emergency service providers, transportation engineers, and local government officials can potentially lead to reduced sizing requirements for cul-de-sacs and acceptance of alternative turn-around options with less impervious cover. The City of Portland, Oregon is one city that successfully established codes supporting narrow streets and alternative turnarounds, accommodating fire engines while reducing impervious surfaces.



Figure 3.3-25 Road with grass swales instead of curb-and-gutter



## CASE STUDY

### **Jordan Cove Watershed Project Case Study, Waterford, CT (Clausen, J, 2007)**

Long Island Sound is an impaired estuary due to low dissolved oxygen (hypoxia), toxic contaminants, pathogen contamination, floatable debris, and habitat degradation. Jordan Cove is a small estuary composed of a long (1.75 miles) narrow (300 feet) neck feeding into an inner cove (100 acres) and then an outer cove (390 acres) before flowing into the Long Island Sound.

The Jordan Cove Urban Watershed Section 319 National Monitoring Program Project was a ten-year study designed to determine the water quantity and quality benefits through the development of an urban subdivision using pollution prevention BMPs. Stormwater runoff from three watersheds – “control”, “traditional”, and “BMP” – was monitored as part of the study. The traditional watershed was developed using ‘traditional’ subdivision requirements. The BMP watershed was developed using a best management practice approach before, during, and after construction. The runoff from these two

watersheds was compared to an existing control watershed. Ultimately, the goal was to show that, by using a BMP approach, pre-development hydrologic conditions can be maintained during and after residential development.

The BMP watershed incorporated several pollution prevention measures as part of its design. A main feature was the replacement of a traditional 28-foot asphalt road with curbs and gutters with a 20-foot wide concrete paver road and grassed bioretention swales. A bioretention cul-de-sac that allows for detention and infiltration of runoff was constructed in lieu of a conventional paved area. Individual bioretention gardens were incorporated into each lot to detain roof and lot runoff. Several alternate driveway surfaces were installed, including asphalt, concrete pavers, and gravel. Houses were constructed in a cluster layout with reduced lawns, low-mow areas, and no-mow areas.

A comparison of imperviousness among the watershed indicates that the BMP watershed has less impervious area than the traditional watershed.

The percentage of acreage taken up by roads and driveways is also lower for the BMP watershed than the traditional watershed. Table 3-21 on the following page shows various costs of BMPs as compared to the traditional watershed. In general, BMPs added development costs. Added costs became apparent during the planning and approval stages of the project. Designing the BMPs required more time by the design engineer, which translated into additional costs for each lot.



## CASE STUDY (CON'T)

### Jordan Cove Watershed Project Case Study, Waterford, CT (Clausen, J, 2007) (con't)

By the end of the 10-year monitoring process, it was clear that traditional residential development has significant adverse impacts on runoff quality and quantity. During the construction phase in the traditional watershed, runoff volume increased twofold. That increase in flow continued during the post-construction period. However, these typical hydrologic alterations were not found in the BMP watershed. On the contrary, a reduction of stormwater runoff was observed. This reduction can be attributed to both excavation of all basements in a relatively short time and proper location of earthen berms to retain and infiltrate stormwater onsite. Decreases in runoff continued in the BMP watershed during the post-construction period. Thus, the BMP watershed project was successful in maintaining predevelopment discharge rates.

Table 3-21 Cost Comparisons of Traditional Development and BSD Development (Source: Jordan Cove Actual Costs, Clausen, J. 2007)

Activity	Traditional	BMP
Cul-de-sac Bioretention	\$1,275	\$2,183
Driveway (asphalt)	\$2,800/lot	\$7,896/lot
Driveway (paver)	N/A	\$7,896/lot
Erosion and sediment control	\$322/lot	\$625/lot
Plantings	\$500/lot	\$650/lot
Planning and design	\$401/lot	\$808/lot
Road and curb	\$23,494	\$102,500
Rain gardens	\$0	\$575/lot
Stormwater collection	\$7,700	\$3,600

### 3.3.3.3 REDUCING PAVED PARKING AND WALKING AREAS

**Description:** Paved parking areas are only useful some of the time, but are always there. Even at peak traffic times, there is often unused parking. Reducing the footprint of paved parking, and reducing the imperviousness by using alternative construction methods, can significantly reduce stormwater runoff and pollution transport. This is true for industrial, commercial, and residential areas, though greater benefits can be achieved when implementing shared or alternative parking arrangements on commercial sites.



Figure 3-26 Pervious parking lot (left) and shared driveway (right).



#### KEY BENEFITS

- More space available for purposes other than parking
- Encourages public and mass transit, and alternative modes of transportation
- Less stormwater runoff
- Lower flow velocities (less erosion potential)
- Lower heat island effect



**SPECIFIC RECOMMENDATIONS:**

Parking space requirements can drive the construction of a lot of excessive impervious cover (see Table 3-22), while actual parking needs are almost always lower than minimum code requirements.

Local governments should investigate their current parking space requirements to see if they may be in excess of what is realistically needed at various types of businesses. They can take into account both local and national experience to see if lower ratios are warranted and feasible in their communities. If so, they may consider reducing the requirements for the minimum number of parking spaces according to business type, land use, or activity. They should also consider enforcing maximums in order to curb excess parking space construction.

**Parking Ratios**

- Increase minimum ratio of compact or sub-compact parking spaces to conventional size spaces
- Add/increase number/ratio of alternative mode parking – motorcycle, bicycle, electric, carpool, vanpool, car-share vehicles, etc.

**Parking Codes**

- Adjust ratios and numbers of parking spots by use type, and also by available transportation type. Where mass transit is available, require less parking. Where pedestrian and bicycle transportation offer good connectivity, require less parking.

**Table 3-22 Conventional Minimum Parking Ratios (Source: ITE, 1987; Smith, 1984; Wells, 1994)**

Land Use	Parking Requirement		Actual Average Parking Demand
	Parking Ratio	Typical Range	
Single family homes	2 spaces per dwelling unit	1.5–2.5	1.11 spaces per dwelling
Shopping center	5 spaces per 1000 ft <sup>2</sup> GFA	4.0–6.5	3.97 per 1000 ft <sup>2</sup> GFA
Convenience store	3.3 spaces per 1000 ft <sup>2</sup> GFA	2.0–10.0	N/A
Industrial	1 space per 1000 ft <sup>2</sup> GFA	0.5–2.0	1.48 per 1000 ft <sup>2</sup> GFA
Medical/ dental office	5.7 spaces per 1000 ft <sup>2</sup> GFA	4.5–10.	4.11 per 1000 ft <sup>2</sup> GFA

GFA = Gross floor area of a building without storage or utility spaces.



Table 3-23 Examples of How Cities Incentivize and Facilitate Lower Parking Requirements

Community	Description of Program
Olympia, WA	Allows reduction in required parking in concert with public transportation
Loudoun County, VA	Allows a reduction of up to 20% of the required parking for any use, building or complex within 1,000 feet of any regularly scheduled bus stop
Chicago, IL	Offers reduction in required parking for buildings connected to underground transit stations*
Hartford, CT	Reduces minimum required parking in return for developer carpool and transit incentives*
Montgomery County, MD	Reduces minimum parking requirements in proximity to rail stations*
Phoenix, AZ	Allows parking requirement relaxations in proximity to bus transit*
Orlando, FL	Allows payments to support a transportation management program in lieu of on-site parking*

\*Source: Federal Transit Administration, 1997

### Parking Lots

- Use permeable pavement materials if possible (pavers, pervious concrete, porous asphalt).
- Any overflow or extra parking areas should be made of pervious pavement materials, or vegetation (grass, etc.) (Figure 3.3-26).
- Encourage shared parking arrangements with other businesses for overflow or even routine parking.
- When feasible, use vertical parking structures to take advantage of the comparatively smaller footprint – they can make economic sense where land costs are very high.
- Parking structures can be expensive on a per space basis, but they have additional benefits:
  - » Less space devoted to parking
  - » Reduced heat island effect
  - » Reduced runoff
  - » Lower costs associated with stormwater management

### Driveways

- Residential driveways are often unnecessarily long, large, and are typically impervious.
- Driveways can be well-suited to permeable pavement/pavers or two “runner strips” for the wheels, with permeable surfaces (or even an infiltration area) between the strips.
- In residential developments with garages, it is possible to use one driveway access for two or more homes’ parking.

### Sidewalks

- Sidewalks are not always necessary on both sides of the street. If access is needed on both sides, crosswalks can be provided.
- Sidewalks are often suitable for pervious material.
- Impervious sidewalks should drain to pervious areas, such as yards or grass channels (rather than into the street or curb/gutter).



Figure 3.3-26 Permeable overflow parking area



Figure 3.3-27 Parking lot bioretention in Johns Creek, GA.

Table 3-24 Perceptions vs Reality for Sidewalks (CWP, 1998b)

1. Sidewalks on only one side of the street are unsafe.	<b>FACT:</b> A recent survey showed that 7.7% of pedestrian accidents occurred on roads with single sidewalks and 7.3% of such accidents occurred on roads with double sidewalks. Roads without sidewalks at all are by far the most hazardous to pedestrians, with 83.5% of pedestrian accidents.
2. Roads without sidewalks on both sides are a legal liability.	<b>FACT:</b> Careful design and policy implementation protects governments and professionals from undue liability.
3. The ADA requires sidewalks on both sides of the street.	<b>FACT:</b> The ADA requires at least one accessible route from public streets, parking areas, and passenger loading zones along a route that generally coincides with that of the general public. There are no specific restrictions on roadway sidewalks.
4. Local government officials do not want to hear complaints from residents regarding sidewalk placement.	<b>FACT:</b> Most complaints occur when sidewalks are installed after the development has been built and occupied, and not during initial construction.
5. Residents want sidewalks on both sides of the street.	<b>FACT:</b> There is no appreciable market difference between houses that are directly served by sidewalks (i.e., the sidewalk is on the same side of the street) and houses not directly served (i.e., sidewalk is on the opposite side of the street). Some residents do prefer to have access to a sidewalk in front of their property, while others prefer no sidewalks. These types of preferences are logically resolved at the time buyers purchase the property.



## CASE STUDY

### Minimizing Parking: City of Greenville, SC (Ellis et al, 2014)

Smaller lots make better use of available land, improve water quality, and save money. Upstate Forever, Furman University, and the City of Greenville conducted a study of commercial parking lots to determine the optimal number of parking spaces for different uses. Researchers used aerial photography and on-the-ground monitoring of 120 commercial parking lots during peak and non-peak hours. The study concluded that there was an excess of off-street parking, with up to 65% of parking spaces empty during peak hours.

Based on the findings from the study, the City of Greenville adjusted its parking requirements. For example, the parking requirement for a medical facility was reduced from 5 spaces per 1,000 square feet to 1.7 spaces per 1,000 feet. The change resulted in a reduction of 3.3 spaces per 1,000 square feet and represents approximately \$6,000-\$18,000 in cost savings for the developer. Under the current code, developers have two options: 1) install the minimum parking spaces required in the new policy or 2) use low-impact development (LID) practices to manage the

stormwater generated by parking spaces over the minimum requirement. Upstate Forever is working with the City of Greenville to create a third alternative in which developers would pay a fee in-lieu if they do not use LID. This new revenue stream will fund local clean water projects.

**Table 3-25 Findings from Parking Study, City of Greenville, SC**

Business Type	Peak Parking Occupancy	Excess Parking
Grocery Stores	35%	65%
Other Restaurants	39%	61%
Discount/Dept. Stores	45%	55%
Pharmacies	45%	55%
Medical Facilities	52%	48%
Offices	58%	42%
Drive-thru Restaurants	58%	42%
Shopping Centers	63%	37%
Health Clubs	74%	26%

## HELPFUL RESOURCES

American Association of State Highway and Transportation Officials (AASHTO). 2004.

**Green Book: A Policy on Geometric Design of Highways and Streets.** 5th Edition.

American Association of State Highway and Transportation Officials (AASHTO). Washington, DC.

Transportation Research Board. 2008. *Multimodal Level of Service Analysis for Urban Streets.* National Cooperative Highway Research Program, Report 616. Washington, D.C.

Transportation Research Board. 2010. *The Highway Capacity Manual.* Washington, DC.

Victoria Transport Policy Institute (VTPI). 2009. *Pedestrian and Bicycle Planning Guide to Best Practices.* Victoria, British Columbia.

### 3.3.3.4 REDUCING BUILDING FOOTPRINTS

**Description:** The impervious footprint of commercial buildings and residences can be reduced by using alternatively designed or taller buildings while maintaining the same floor-to-area ratio.



#### KEY BENEFITS

- Reduces impervious cover
- Minimizes land disturbance
- Limits clearing and grading
- Carbon sequestration
- More efficient use of valuable urban land
- Reduces urban heat island

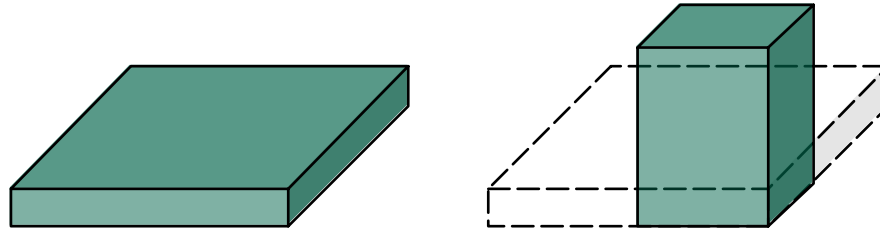

Figure 3.3-28 Building up rather than out can reduce the amount of impervious cover

**SPECIFIC RECOMMENDATIONS:**

Encourage site designers to create taller building designs that have smaller impervious footprints by:

- Creating incentives or requirements for buildings with smaller footprints instead of large single-story structures.
- Creating a floor-to-area ratio (FAR) bonus for taller buildings that have a smaller impervious footprint.

**How Local Codes Can Be Amended to Support This Practice:**

Local development codes can support this practice in the following ways:

- Offer incentives that encourage local communities to increase density
- Consider variances to reduce lot size requirements
- Consider variances to reduce setback requirements
- Reduce height restrictions and increase FARs



Figure 3.3-29 Building up rather than out can reduce the amount of impervious cover

Table 3-26 Local Code Changes to Support Reducing Building Footprints

Topic	Typical Local Code Conflicts	How Conflicts Can Be Resolved
Lot Size Requirements	Lot size requirements usually accommodate larger building footprints.	Add a separate set of lot size requirements to encourage smaller building footprints.
Minimum Setback Requirements	Setback requirements usually accommodate larger building footprints.	Add a separate set of setback requirements that encourages smaller building footprints.
Height Restrictions	Height restrictions usually encourage more horizontal building construction.	Consider variances for height restrictions to encourage more vertical construction, rather than horizontal. Offer floor-to-area ratio bonuses (see specific recommendations).

## References

American Association of State Highway and Transportation Officials. 2001. *A Policy on Geometric Design of Highways and Streets (Fourth Edition)*. American Association of State Highway and Transportation Officials (AASHTO), Washington, DC.

American Association of State Highway and Transportation Officials. 2004. *Green Book: A Policy on Geometric Design of Highways and Streets (Fifth Edition)*. American Association of State Highway and Transportation Officials (AASHTO), Washington, DC.

American Society of Landscape Architects. 2009. *The Sustainable Site Initiative: Guidelines and Performance Benchmarks*. American Society of Landscape Architects (ASLA), Lady Bird Johnson Wildflower Center at The University of Texas at Austin.

Atlanta Regional Commission. 2015. *Community Choices Smart Growth Toolkit*. Atlanta Regional Commission (ARC), Atlanta, Georgia.

Bob Moore Construction. 2009. *Overcoming the Unique Challenges of Infill Developments to Deliver a Gold LEED for Core & Shell Project*. Bob Moore Construction (BMC), Arlington, TX.

Cappiella K., T. Wright, and T. Schueler. 2006. *Urban Watershed Forestry Manual Part 2: Conserving and Planting Trees at Development Sites*.

Center for Watershed Protection (CWP), Ellicott City, MD.

Center for Watershed Protection. 1998. *Consensus Agreement on Model Development Principles to Protect Our Streams, Lakes, and Wetlands*.

Center for Watershed Protection (CWP), Ellicott City, MD.

Center for Watershed Protection. 1998. *Better Site Design: A Handbook for Changing Development Rules in your Community*. Center for Watershed Protection (CWP), Ellicott City, MD.

Center for Watershed Protection. 2009. *Recommended Development Principles for Richland County, South Carolina Consensus of the Site Planning Roundtable*. Center for Watershed Protection (CWP), Ellicott City, MD.

City of Flowery Branch. *Article 8, Planned Unit Development District Zoning Ordinance City of Flowery Branch*. City of Flowery Branch, GA.

City of Savannah. 2012. *Landscape and Tree Ordinance Compliance Manual*. Savannah, GA.

City of Smyrna. 2003. *Article II. Tree Conservation and Replacement*. City of Smyrna Tree Conservation and Replacement Ordinance, Smyrna, GA.

Clausen, John C., 2007. *Jordan Cove Watershed Project – Final Report*. Department of Natural Resources Management and Engineering College of Agriculture and Natural Resources. University of Connecticut.

De Sousa, Christopher, Lily-Ann D'Souza. 2013. *Atlantic Station, Atlanta, Georgia: A Sustainable Brownfield Revitalization Best Practice*. UIC Institute for Environmental Science and Policy, Chicago, IL.

Ellis, K., C. Berg, D. Caraco, S. Drescher, G. Hoffmann, B. Keppler, M. LaRocco, and A. Turner. 2014. *Low Impact Development in Coastal South Carolina: A Planning and Design Guide*. ACE Basin and North Inlet – Winyah Bay National Estuarine Research Reserves.

The Federal Interagency Stream Restoration Working Group. 1998. *Stream Corridor Restoration: Principles, Processes, and Practices*. The Federal Interagency Stream Restoration Working Group (FISRWG).

Federal Transit Administration. 1997. *Parking Supply Management*. Federal Transit Administration. Washington, D.C.

Georgia Department of Community Affairs. 2005. *A Guide to Using Georgia's Urban Redevelopment Act*. Georgia Department of Community Affairs (DCA). Atlanta, GA.

Georgia Department of Community Affairs. 2015. *Infill Development Program*. Georgia Department of Community Affairs (DCA). Atlanta, GA.



## References (con't)

Georgia Department of Natural Resources. 2006. *Green Growth Guidelines: A Low Impact Development Strategy for Coastal Georgia*. Georgia Department of Natural Resources, Brunswick, GA.

Georgia Department of Natural Resources Wildlife Resources Division. 2005. *A Comprehensive Wildlife Conservation Strategy for Georgia*. Georgia Department of Natural Resources Wildlife Resources Division, Social Circle, GA.

Georgia Forestry Commission. 2012. *Georgia: The State of the Urban Forest Report 2012*. Georgia Forestry Commission, Alamo, GA.

Georgia Land Conservation Program. *Georgia Conservation Tax Credit 2012*. Georgia Department of Natural Resources, Social Circle, GA.

Hirschman, David J., John Kosco. 2008. *Managing Stormwater in Your Community: A Guide for Building an Effective Post-Construction Program*. Center for Watershed Protection, Ellicott City, MD.

Institute of Transportation Engineers. 1987. *Parking Generation (Second Edition)*. Institute of Transportation Engineers, Washington, DC.

Institute of Transportation Engineers. 1997. *Guidelines for Residential Subdivision Street Design*. Institute of Transportation Engineers (ITE), Washington, DC.

MacMullin, Ed and Sarah Reich. 2007. *The Economics of Low-Impact Development: A Literature Review*. ECONorthwest, Eugene, OR.

Mero, Ted. 2013. *The Living Landscape*. Mary Ann Liebert, Inc. New Rochelle, NY.

National Oceanic and Atmospheric Administration, U.S. Environmental Protection Agency, International City/County Management Association, and Rhode Island Sea Grant. 2009. *Smart Growth for Coastal and Waterfront Communities*. National Oceanic and Atmospheric Administration (NOAA), Silver Spring, MD.

U.S. Environmental Protection Agency (EPA), Washington, DC. *International City/County Management Association (ICMA)*, Washington, DC. Rhode Island Sea Grant, Narragansett, RI.

Nevue Ngan Associates, Eisen|Letunic, Van Meter Williams Pollack LLP, ICF International. 2009. *Stormwater Management Handbook: Implementing Green Infrastructure in Northern Kentucky Communities*. ICF International. Fairfax, Va. Nevue Ngan Associates. Portland, OR.

Rayburn, Cory, Susan Rutherford. 2014. *Implementing Green Infrastructure: Atlanta's Post-Development Stormwater Ordinance*. City of Atlanta Department of Watershed Management, Atlanta, GA.

Rhode Island Department of Environmental Management (RI DEM) and Coastal Resources Man-

agement Council (CRMC). 2010. *RI Stormwater Design and Installation Standards Manual*. Rhode Island Department of Environmental Management (RI DEM), Providence, RI. Coastal Resources Management Council (CRMC), Wakefield, RI.

Rhode Island Department of Environmental Management (RI DEM) and Coastal Resources Management Council (CRMC). 2011. *Rhode Island Low Impact Development Site Planning and Design Guidance Manual*. Rhode Island Department of Environmental Management (RI DEM), Providence, RI. Coastal Resources Management Council (CRMC), Wakefield, RI.

Smart Growth America. 2015. *What Is "Smart Growth?"*. Smart Growth America. Washington, DC.

Smith, Thomas. 1984. *Flexible Parking Requirements. Planning Advisory Service Report No. 377*. American Planning Association, Chicago, Illinois.

Wells, C. 1994. *Impervious Surface Reduction Technical Study. Draft Report*. City of Olympia Public Works Department. Washington Department of Ecology.

University of Georgia Cooperative Extension. 2007. *Best Management Practices for Landscape Water Conservation*. Bulletin 1329.

University of Georgia Cooperative Extension. 2009. *Environmentally Friendly Landscape Practices*. Circular 967.

## References (con't)

U.S. Environmental Protection Agency (EPA). 2006. *Protecting Water Resources with Higher Density Development*. U.S. Environmental Protection Agency. Washington, DC.

U.S. Environmental Protection Agency (EPA). 2015. *Smart Growth and Economic Success: Investing in Infill Development*. U.S. Environmental Protection Agency (EPA). Washington, DC.

U.S. Environmental Protection Agency (EPA). 2015. *Brownfields Definition*. Environmental Protection Agency (EPA). Washington, DC.

Westerfield, R., D. Pulis. 2009. *Environmentally Friendly Landscape Practices*. University of Georgia Cooperative Extension. Athens, GA.

Winer-Skonovd, R., D. Hirschman, H.Y. Kwon and C. Swann. 2006. *Synthesis of Existing Cost Information for LID vs. Conventional Practices*. Center for Watershed Protection. Ellicott City, MD.

## 4. Implementing Stormwater Management Requirements for Development

### 4.1 Overview

Description: Requirements and standards for controlling runoff from development are critical to addressing water quantity and quality impacts of post-construction urban stormwater. In addition, they are a required component of NPDES municipal stormwater programs. The unified stormwater sizing criteria represent comprehensive rules for various storm events in Georgia.



#### KEY CONSIDERATIONS

The key concepts for addressing the effects of development on stormwater include:

- Natural Resources Inventory
- Stormwater Better Site Design
- Stormwater Credits for Natural Area Conservation
- Unified Stormwater Sizing Criteria
- Runoff Reduction Practices
- Guidance on Structural Stormwater Controls
- Downstream Assessments
- Stormwater Management Site Plans

Adoption of a comprehensive and integrated set of stormwater management requirements for new development and redevelopment projects is one of the key components of a comprehensive local stormwater management program. Performance requirements and standards for controlling runoff from development are critical to addressing both the water quantity and quality impacts of post-construction urban stormwater and are a required component of NPDES municipal stormwater programs.

Stormwater management standards must also be supported by a set of design and management tools, through an integrated design approach for implementing structural and nonstructural stormwater controls. The following elements of a local toolbox for addressing development activities are described in this chapter:

- **Natural Resources Inventory** – Prior to the start of any land disturbing activities (including any clearing and grading activities), acceptable site reconnaissance and surveying techniques should be used to complete a thorough assessment of the natural resources, both terrestrial and aquatic, found on a development site. Some of these natural resources may be protected by federal and state regulations and/or local zoning rules.
- **Stormwater Better Site Design** – The first step in addressing stormwater management begins with the site planning and design process. The goal of better site design is to reduce the amount of runoff and pollutants that are generated from a development site and provide for some non-structural on-site treatment

and control of runoff by implementing a combination of approaches collectively known as stormwater better site design practices. These include maximizing the protection of natural features and resources, developing a site design which minimizes impact, reducing overall site imperviousness, and utilizing natural systems for stormwater management.

- **Stormwater Credits for Natural Area Conservation** – One better site design practice, conservation of natural areas, includes an additional stormwater credit. If a natural area is conserved (with a conservation easement or other similar mechanism), the runoff reduction volume and/or water quality volume will be reduced. This credit is intended to provide developers and site designers with an incentive to conserve natural areas that can reduce the volume of stormwater runoff and minimize the pollutant loads from a site. The credit directly translates into cost savings for the developer by reducing the size of structural stormwater control and conveyance facilities.
- **Unified Stormwater Sizing Criteria** – An integrated set of design criteria for stormwater quality and quantity management that addresses the entire range of hydrologic events. These criteria allow site engineers to calculate the stormwater control volumes required for runoff reduction volume and/or water quality volume, downstream channel protection, and overbank and extreme flood protection.
- **Runoff Reduction Practices** – Runoff reduction practices are stormwater management practices that are used to disconnect

impervious and disturbed pervious surfaces from the storm drain system, thereby reducing post-construction stormwater runoff rates, volumes, and pollutant loads. Since runoff reduction practices actually eliminate stormwater runoff (and the pollutants associated with it), rather than simply treating or detaining runoff, they can contribute to all of the Unified Stormwater Sizing Criteria, while providing many additional benefits.

- **Guidance on Structural Stormwater Controls** – When runoff reduction practices are insufficient, this Manual recommends a set of structural stormwater controls that can be used to meet stormwater management water quantity and quality goals.
- **Downstream Assessments** – Peak flow downstream assessments can be required to ensure that a proposed development is not adversely impacting downstream properties after the stormwater management requirements have been addressed. These assessments can also potentially be used to waive the need for detention for overbank and extreme flood control.
- **Stormwater Management Site Plans** – Communities should require the preparation of a stormwater management site plan for development activities. A stormwater site plan is a comprehensive report that contains the technical information and analysis to allow a local review authority to determine whether a proposed new development or redevelopment project meets the local stormwater regulatory requirements.

Figure 4.1-1 illustrates how these design tools would be used in the development process to address local stormwater management requirements.

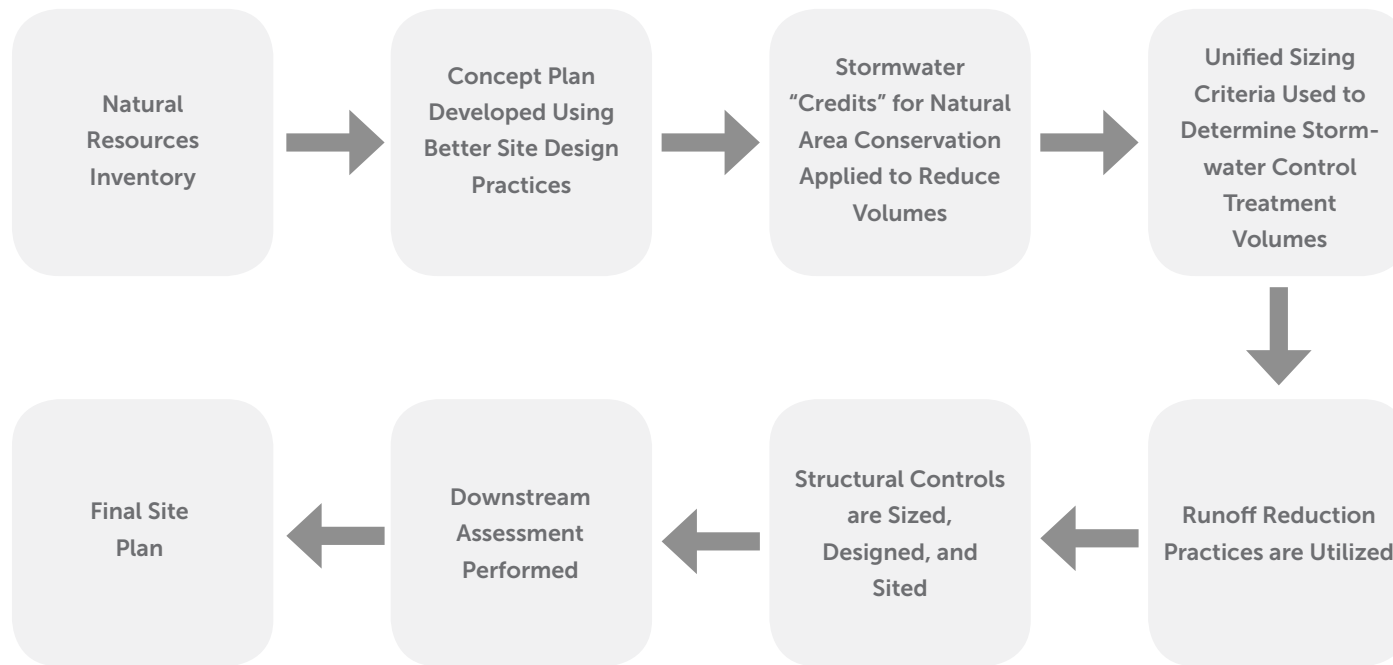

Figure 4.1-1 Typical Stormwater Management System Design Process

### Better Site Design, Runoff Reduction, and the Unified Stormwater Sizing Criteria

The Unified Stormwater Sizing Criteria, which are incorporated into the Standards for Development described in [Section 4.2](#) represent comprehensive rules for various storm events in Georgia. Rules regarding the quality of runoff are applied to small storm events (1.2"), while rules regarding the quantity and rate of runoff are applied to larger storm events (specifically, the 1-year, 25-year, and 100-year return intervals).

Some stormwater practices are best suited to address runoff quality, while others are best suited to address runoff quantity. However, better site design and runoff reduction practices address both simultaneously. As discussed in [Chapter 3](#), by reducing the impervious cover associated with a development, better site design techniques reduce the amount of runoff being generated by a development in the first place. Runoff reduction practices, on the other hand, eliminate some of the runoff after it is generated. Instead of treating or detaining the runoff like a typical water quality practice, or detaining it like a typical water quantity practice, they remove it – remov-

ing the pollutants along with it. Runoff reduction practices remove runoff through a variety of processes. Infiltration (sending runoff into the ground) may be the most common means, but it is not the only one. Runoff reduction can also be achieved through evaporation, transpiration, or rainwater harvesting and reuse. Through these processes, runoff reduction practices both improve water quality, and reduce the water quantity that must be managed for larger storm events.

Taken together, better site design and runoff reduction practices provide many other benefits as well:

- **Maintain Pre-Development Site Hydrology:** By reducing stormwater runoff volumes and rates, post-development site hydrology is kept closer to pre-development site hydrology (the site operates much more like a natural system).
- **Reduced Combined Sewer Overflow Events:** Better site design and runoff reduction practices help reduce the magnitude and frequency of combined sewer overflow events.
- **Urban Heat Island Mitigation:** The trees, shrubs and other vegetation associated with better

site design and runoff reduction practices create shade, reflect solar radiation and emit water vapor, all of which create cooler temperatures in urban environments and help mitigate the impacts of urban heat islands.

- **Reduced Energy Demand:** Trees, shrubs and other vegetation help lower ambient air temperatures and, when incorporated on and around buildings, help insulate buildings from temperature swings, decreasing the amount of energy used for heating and cooling.

U.S. Environmental Protection Agency (US EPA). 2008. "Environmental Benefits of Green Infrastructure." [Managing Wet Weather with Green Infrastructure](#). Accessed: June 27, 2008.



## 4.2 Standards for Development

Description: A comprehensive set of performance standards for stormwater management should be incorporated into community development and redevelopment requirements.

### KEY CONSIDERATIONS

The following twelve (12) standards are recommended performance requirements for new development or redevelopment sites:

- Standard #1 – Natural Resource Inventory
- Standard #2 – Better Site Design Practices for Stormwater Management
- Standard #3 – Runoff Reduction
- Standard #4 – Water Quality
- Standard #5 – Stream Channel Protection
- Standard #6 – Overbank Flood Protection
- Standard #7 – Extreme Flood Protection
- Standard #8 – Downstream Analysis
- Standard #9 – Construction Erosion and Sedimentation Control
- Standard #10 – Stormwater Management System Operation and Maintenance
- Standard #11 – Pollution Prevention
- Standard #12 – Stormwater Management Site Plan



### 4.2.1 Introduction

This section presents a comprehensive set of performance standards for stormwater management for development and redevelopment activities. These standards provide Georgia communities with an integrated approach to address the water quality and quantity problems associated with stormwater runoff due to urban development. When adopted by Georgia communities, these standards will help maintain the quality and quantity of their community waters. They are designed to assist local governments in complying with regulatory and programmatic requirements for various state and Federal programs, including the National Pollutant Discharge Elimination System (NPDES) Municipal Separate Storm Sewer System (MS4) permit program and the National Flood Insurance Program under FEMA.

These standards should be incorporated into a community's development requirements and supported by the plan review process, as well as inspection, tracking, and maintenance procedures. Where appropriate, they may be modified to meet local or watershed-specific stormwater management goals and objectives.

The goal of stormwater management requirements for areas of new development and redevelopment is to reduce the negative impacts of post-construction stormwater runoff on the watershed such as deteriorating water quality, reduced base flows, stream entrenchment, stream bank instability, and erosion. A reduction in negative impacts can be achieved by (1) maximizing

the use of site design and nonstructural methods to reduce impervious cover and the generation of runoff and pollutants; (2) managing and treating stormwater runoff through the use of structural stormwater controls; and (3) implementing pollution prevention practices to limit potential stormwater contaminants. The stormwater management standards presented here incorporate these concepts and cover the entire cycle of development, from site planning through long-term maintenance of stormwater management facilities.

### 4.2.2 Applicability

It is recommended that the stormwater management standards listed below be required for any new development or redevelopment site that meets one or more of the following criteria:

1. New development that includes the creation or addition of 5,000 square feet or greater of new impervious surface area, or that involves land disturbing activity of 1 acre of land or greater.
2. Redevelopment that includes the creation or addition of 5,000 square feet or greater of new impervious surface area, or that involves land disturbing activity of 1 acre or more.
3. Any commercial or industrial new development or redevelopment, regardless of size, with a Standard Industrial Classification (SIC) code that falls under the NPDES Industrial Stormwater Permit program, or is a hotspot land use as defined below.

Since runoff from smaller developments can cause water quality and quantity impacts as well, an individual community may choose to adopt more stringent area criteria, especially if it determines that a significant amount of development in the community falls below these thresholds. In addition, a community may choose to apply stormwater management standards on a case-by-case basis to smaller developments.

#### Definitions

*New development* is defined as land disturbing activities, structural development (construction, installation or expansion of a building or other structure), and/or creation of impervious surfaces on a previously undeveloped site.

*Redevelopment* is defined as structural development (construction, installation, or expansion of a building or other structure), creation or addition of impervious surfaces, replacement of impervious surfaces not as part of routine maintenance, and land disturbing activities associated with structural or impervious development on a previously developed site. Redevelopment does not include such activities as exterior remodeling.

*Previously developed site* is defined as a site that has been altered by paving, construction, and/or land use that would typically have required regulatory permitting to have been initiated (alterations may exist now or in the past).

A *hotspot* is defined as a land use or activity on a site that produces higher concentrations of trace metals, hydrocarbons, or other priority pollutants than are normally found in urban stormwater runoff. Examples of hotspots include gas stations, vehicle service and maintenance areas, industrial facilities such as salvage yards (both permitted under the Industrial General Permit and others), material storage sites, garbage transfer facilities, and commercial parking lots with high-intensity use.

The goals and policies of individual communities should determine the specific definition of *pre-development*. It is recommended that pre-development be defined as “natural, undisturbed conditions.” This can be simplified to a set type of vegetative condition, such as “woods in good condition,” if appropriate. However, where redevelopment incentives are desired, or where flooding concerns do not currently exist, pre-development may be defined as the condition of the site immediately prior to the implementation of the proposed project.

### Exemptions

In order to avoid excessive regulation on individual residential lots, maintenance and repair efforts, and environmental projects, the following development activities are recommended to be exempted from the stormwater management standards:

1. Individual single family residential lots (single family lots that are part of a subdivision or phased development project should not be exempt from the standards);
2. Additions or modifications to existing single-family structures;
3. Duplex residential units that do not meet the criteria listed above.
4. Land disturbing activity conducted by local, state, authority, or federal agencies, solely to respond to an emergency need to protect life, limb, or property or conduct emergency repairs;
5. Land disturbing activity that consists solely of cutting a trench for utility work and related pavement replacement that maintains the original grade; and
6. Land disturbing activity conducted by local, state, authority, or federal agencies, whose sole purpose is to implement stormwater management or environmental restoration.

As noted above, since runoff from smaller developments can cause water quality and quantity impacts as well, an individual community may choose not to adopt these exemptions. The City of Atlanta, for example, currently requires that stormwater management measures be utilized for any new home or addition that is greater than 1,000 square feet of impervious surface. [See the Case Study in Section 4.4.4.](#)

### Additional Requirements

New development or redevelopment in critical or sensitive areas, or as identified through a watershed study or plan, may be subject to additional performance and/or regulatory criteria. Furthermore, these sites may need to utilize or restrict certain structural controls in order to protect a special resource or address certain water quality or drainage problems identified for a drainage area. For example, in Coastal Georgia, areas that discharge into designated shellfish harvesting areas are recommended by the Coastal Stormwater Supplement to adopt Special Criteria including increasing runoff reduction criteria to the 1.5” storm and provide a minimum 50-foot aquatic buffer.

### 4.2.3 Stormwater Management Standards

It is recommended that the following stormwater management performance standards be adopted for new development or redevelopment sites falling under the applicability criteria above. It is further recommended that these twelve (12) standards be adopted in whole to create a comprehensive stormwater management approach. However, an individual community may choose to adopt some of the standards rather than the entire set, or modify individual standards, depending upon its regulatory requirements and specific local approach to stormwater management. Specific required criteria for communities covered by a Municipal Separate Storm Sewer System (MS4) permit are delineated in the permit.

#### STANDARD #1 – NATURAL RESOURCE INVENTORY

Prior to the start of any land disturbing activities (including any clearing or grading activities), acceptable site reconnaissance and surveying techniques shall be used to complete a thorough assessment of the natural resources, both terrestrial and aquatic, found on a development site. The site's critical natural features and drainage patterns shall be identified early in the site planning process. The natural resources inventory shall be used to identify and map the natural resources on site, as they exist prior to the start of any land disturbing activities. The identification, and subsequent preservation and/or restoration of these natural resources, through the use of better site design practices, helps reduce the negative

impacts of the land development process "by design".

Resources to be identified and mapped during the natural resources inventory, include, at a minimum (as applicable):

- Topography and Steep Slopes (i.e., Areas with Slopes Greater Than 15%)
- Natural Drainage Divides and Patterns
- Natural Drainage Features (e.g., swales, basins, depressional areas)
- Wetlands
- Water Bodies
- Floodplains
- Aquatic Buffers
- Shellfish Harvesting Areas
- Soils
- Erodible Soils
- Groundwater Recharge Areas
- Wellhead Protection Areas
- Trees and Other Existing Vegetation
- High Quality Habitat Areas
- Protected River Corridors
- Protected Mountains
- Karst Areas

All relevant resources shall be shown on the Stormwater Site Plan (Standard #12).

#### STANDARD #2 – BETTER SITE DESIGN PRACTICES FOR STORMWATER MANAGEMENT

All site designs shall implement a combination of approaches collectively known as stormwater better site design practices to the maximum extent practicable. Through the use of these practices and techniques, the impacts of urbanization on the natural hydrology of the site and water quality can be significantly reduced. The goal is to reduce the amount of stormwater runoff and pollutants that are generated, provide for natural on-site control and treatment of runoff, and optimize the location of stormwater management facilities. Better site design concepts can be viewed as both water quantity and water quality management tools, and can reduce the size and cost of structural BMPs.

Site designs shall preserve the natural drainage and treatment systems and reduce the generation of additional stormwater runoff and pollutants to the maximum extent practicable. More information on Better Site Design is provided in [Chapter 3](#).

The use of certain better site design practices that provide water quality benefits allows for a reduction (known as a "credit") of the water quality volume. The applicable design practices and stormwater site design credits are covered in [Volume 2, Section 2.3](#).

### STANDARD #3 – RUNOFF REDUCTION

Runoff reduction practices shall be sized and designed to retain the first 1.0 inch of rainfall on the site to the maximum extent practicable. Runoff reduction practices are stormwater BMPs used to disconnect impervious and disturbed pervious surfaces from the storm drain system, thereby reducing post-construction stormwater runoff rates, volumes, and pollutant loads. Since runoff reduction practices actually eliminate stormwater runoff (and the pollutants associated with it), rather than simply treating or detaining runoff, they can contribute to several of the other performance standards, while providing many additional benefits. If the entire 1.0 inch of rainfall can be retained onsite using runoff reduction methods, the community may choose to waive the water quality treatment volume in Standard #4. If the entire 1.0-inch runoff reduction standard cannot be achieved, the remaining runoff from the 1.2-inch rainfall event must be treated by BMPs to remove at least 80% of the calculated average annual post-development TSS loading from the site per Standard #4 Water Quality.

Runoff reduction percentages are assigned to applicable BMPs that reduce the amount of stormwater required for treatment, and subsequently reduce the other stormwater management volumes, incentivizing their use. Runoff reduction practices inherently reduce TSS and other pollutants to provide water quality treatment (i.e. 100% pollutant removal for stormwater retention, infiltration, evaporation, transpiration,

or rainwater harvesting and reuse). This standard is quantified and expressed in terms of engineering design criteria through the specification of the runoff reduction volume ( $RR_v$ ), which is equal to the runoff generated on a site from 1.0 inches of rainfall. Individual runoff reductions specific to each practice are described in detail in [Volume 2, Chapter 4](#).

While runoff reduction practices provide important water quality benefits, as described in [Chapter 2](#), certain conditions, such as karst topography, soils with very low infiltration rates, high groundwater, or shallow bedrock, may lead a community to choose to waive or reduce the runoff reduction requirement. Alternatively, these conditions can be addressed on a site-specific basis. If the  $RR_v$  of 1.0 inches of rainfall cannot be achieved, adequate documentation should be provided to the local development review authority to show that no additional runoff reduction practices can be used on the development site.



### CASE STUDY

#### City of Atlanta's Runoff Reduction Requirement

In February 2013, the City of Atlanta amended its Post-Development Stormwater Management Ordinance to require green infrastructure on new and redevelopment projects in the city. One of the most significant revisions to the ordinance was a volume-based runoff reduction requirement. Commercial and single family residential developments must capture the first 1.0" of runoff and reduce this volume onsite using infiltration, evapotranspiration, and/or harvesting the rainwater and reusing it in irrigation or indoor plumbing systems. This new standard replaces the previous water quality requirement of capturing and removing 80% of the total suspended solids from the first 1.2" of runoff on commercial sites.

In order to implement the runoff reduction standard, the City adopted the Coastal Stormwater Supplement (CSS) of the Georgia Stormwater Management Manual (Blue Book). The CSS (2009) includes these runoff reduction BMPs and provides design parameters and a specified credit system for implementation. Because these practices both clean and reduce the volume of runoff, quantifiable credit is given to satisfy both runoff reduction and attenuation requirements, reducing the size of detention ponds or underground vaults.

Source: Rayburn, Rutherford, *Implementing Green Infrastructure: Atlanta's Post-Development Stormwater Ordinance*, City of Atlanta Department of Watershed Management, 2013.

**STANDARD #4 – WATER QUALITY**

Stormwater management systems shall be designed to retain or treat the runoff from 85% of the storms that occur in an average year, and reduce average annual post-development total suspended solids loadings by 80%. Averaged from rainfall events across the state of Georgia, this equates to treating storm events of 1.2 inches or less, as well as the first 1.2 inches of runoff for all larger storm events.

Communities that choose to adopt runoff reduction may choose to waive the water quality treatment volume from this standard if 100% of the 1.0 inch runoff reduction volume is achieved. If the entire 1.0-inch runoff reduction standard cannot be achieved, the remaining runoff from the 1.2-inch rainfall event must be treated by BMPs to remove at least 80% of the calculated average annual post-development TSS loading from the site.

This standard is quantified and expressed in terms of engineering design criteria through specification of the water quality volume ( $WQ_v$ ), which is equal to the runoff generated on a site from 1.2 inches of rainfall. The  $WQ_v$  must be treated to the 80% TSS removal performance goal.

This standard assumes that BMPs will be designed, constructed and maintained according to the criteria in this Manual. Stormwater discharges from land uses or activities with higher or special potential pollutant loadings may require the

use of specific structural practices and pollution prevention practices. A detailed overview of BMPs is provided in [Volume 2, Chapter 4](#).

**STANDARD #5 – STREAM CHANNEL PROTECTION**

Stream channel protection shall be provided by using all of the following three approaches: (1) 24-hour extended detention storage of the 1-year, 24-hour return frequency storm event; (2) erosion prevention measures, such as energy dissipation and velocity control; and (3) preservation of the applicable stream buffer. Stream channel protection requirements are further described in [Volume 2, Section 2.2.4.2](#).

The first method of providing stream bank protection is the extended detention of the 1-year, 24-hour storm for a period of 24 hours using BMPs. It is known that the increase in runoff due to development can dramatically increase stream channel erosion. This standard is intended to reduce the frequency, magnitude and duration of post-development bankfull flow conditions. The volume to be detained is also known as the channel protection volume ( $CP_v$ ). The use of nonstructural site design practices and runoff reduction BMPs that reduce the total amount of runoff may also reduce  $CP_v$  by a proportional amount (See [Volume 2, Section 3.1.7.5](#) for calculations that incorporate the runoff reduction volume into larger storm events).

This requirement may be waived by a local jurisdiction for sites that discharge directly or through piped stormwater drainage systems into larger

streams, rivers, wetlands, lakes, estuaries, tidal waters, or other situations where the reduction in the smaller flows will not have an impact on stream bank or channel integrity.

The second stream bank protection method is to implement velocity control, energy dissipation, stream bank stabilization, and erosion prevention practices and structures as necessary in the stormwater management system to prevent downstream erosion and stream bank damage. Energy dissipation and velocity control methods are discussed in [Volume 2, Section 5.5](#).

The third method of providing for stream channel protection is through the establishment of riparian stream buffers on the development site. Stream buffers not only provide channel protection but also water quality benefits and protection of streamside properties from flooding. It is recommended that 100-foot buffers be established where feasible. Additional stream buffer guidelines are presented in [Volume 2, Section 2.3](#).



## STANDARD #6 – OVERBANK FLOOD PROTECTION

Overbank flood protection shall be provided by controlling the post-development peak discharge rate to the pre-development rate (natural or existing condition, as applicable) for the 25-year, 24-hour return frequency storm event. If control of the 1-year, 24-hour storm (Standard #5) is exempted, then overbank flood protection shall be provided by controlling the post-development peak discharge rate to the pre-development rate (natural or existing condition, as applicable) for the 2-year through the 25-year return frequency storm events. Overbank flood protection requirements are further described in [Volume 2, Section 2.2.4.3](#).

The use of nonstructural site design practices and runoff reduction BMPs that reduce the total amount of runoff will also reduce  $Q_{p25}$  by a proportional amount (See [Volume 2, Section 3.1.7.5](#) for calculations that incorporate the runoff reduction volume into larger storm events).

Smaller storm events (e.g., 2-year and 10-year) are effectively controlled through a combination of extended detention for the 1-year, 24-hour event (channel protection) and control of the 25-year peak rate for overbank flood protection. These design standards, therefore, are intended to be used in unison.

This standard may be adjusted by a local jurisdiction for areas where all downstream conveyances and receiving waters have the natural capacity to

handle the full build-out 25-year storm through a combination of channel capacity and overbank flood storage without increasing flood stages above pre-development flood levels (natural or existing condition, as applicable).

## STANDARD #7 – EXTREME FLOOD PROTECTION

Extreme flood protection shall be provided by controlling and/or safely conveying the 100-year, 24-hour storm event (denoted  $Q_t$ ). This is accomplished either by (1) controlling  $Q_t$  through BMPs to maintain the existing 100-year floodplain, or (2) by sizing the on-site conveyance system to safely pass  $Q_t$  and allowing it to discharge into a receiving water whose protected floodplain is sufficiently sized to account for extreme flow increases without causing damage. In this case, the extreme flood protection criterion may be waived by a local jurisdiction in lieu of provision of safe and effective conveyance to receiving waters that have the capacity to handle flow increases to maintain 100-year level.

The use of nonstructural site design practices and runoff reduction BMPs that reduce the total amount of runoff will also reduce  $Q_t$  by a proportional amount (See [Volume 2, Section 3.1.7.5](#) for calculations that incorporate the runoff reduction volume into larger storm events).

Existing and future floodplain areas shall be preserved to the extent possible. Extreme flood protection requirements are further described in [Volume 2, Section 2.2.4.4](#).

## STANDARD #8 – DOWNSTREAM ANALYSIS

Due to peak flow timing and runoff volume effects, some structural practices fail to reduce discharge peaks to pre-development levels downstream from the development site. A downstream peak flow analysis shall be provided to the point in the watershed downstream of the site or the stormwater management system where the area of the site comprises 10% of the total drainage area. This is to help ensure that there are minimal downstream impacts from the developed site. The downstream analysis may result in the need to re-size BMPs, or may allow the waiving of some unnecessary peak flow controls altogether. The use of a downstream analysis and the “ten-percent” rule are discussed in [Volume 2, Section 3.1.9](#).

**STANDARD #9 – CONSTRUCTION EROSION AND SEDIMENTATION CONTROL**

Erosion and sedimentation control practices shall be utilized during the construction phase of development or during any land disturbing activities.

All new development and redevelopment sites must meet the regulatory requirements for land disturbance activities under the Georgia Erosion and Sedimentation Control Act and/or the NPDES General Permit for Construction Activities. This involves the preparation and implementation of an approved erosion and sedimentation control plan, including appropriate best management practices, during the construction phase of development. Further guidance on practices for construction site erosion and sedimentation control can be found in the latest version of the *Manual for Erosion and Sediment Control in Georgia*.

Better site design practices and techniques that can reduce the total amount of area that needs to be cleared and graded should be implemented wherever possible. It is essential that erosion and sedimentation control be considered and implemented in stormwater concept plans and throughout the construction phase to prevent damage to natural stormwater drainage systems and previously constructed best management practices and conveyance facilities.

**STANDARD #10 – STORMWATER MANAGEMENT SYSTEM OPERATION AND MAINTENANCE**

The stormwater management system, including all best management practices and conveyances,

shall have an operation and maintenance plan to ensure that it continues to function as designed. See [Section 5.2](#) and [Volume 2, Appendix E](#) for more information on stormwater operation and maintenance.

All new development and redevelopment sites are to prepare a comprehensive operation and maintenance plan for the on-site stormwater management system. This is to include all of the stormwater management system components, including drainage facilities, BMPs, and conveyance systems. To ensure that stormwater management systems function as they were designed and constructed, the operation and maintenance plan must provide: (1) a clear assignment of stormwater inspection and maintenance responsibilities; (2) the routine and non-routine maintenance tasks to be undertaken; (3) a schedule for inspection and maintenance; and (4) any necessary legally binding maintenance agreements.

**STANDARD #11 – POLLUTION PREVENTION**

To the maximum extent practicable, the development or redevelopment project shall implement pollutant prevention practices and have a stormwater pollution prevention plan.

All new development and redevelopment sites are to consider pollution prevention in the design and operation of the site, and prepare a formal stormwater pollution prevention plan if circumstances warrant it. Specific land use types and hotspots may need to implement more rigorous pollution prevention practices. The preparation of pollu-

tion prevention plans and the full set of pollution prevention practices are covered in Volume 3 of this Manual.

**STANDARD #12 – STORMWATER MANAGEMENT SITE PLAN**

The development project shall prepare a stormwater management site plan for local government review that addresses Standard #1 through Standard #11.

All new development and redevelopment sites will require the preparation of a stormwater management site plan for development activities. A stormwater site plan is a comprehensive report that contains the technical information and analysis to allow a local review authority to determine whether a proposed new development or redevelopment project meets local stormwater regulatory requirements. See [Section 4.3](#) and other local stormwater regulatory requirements for specific guidance.

## 4.3 Stormwater Management Site Plans

**Description:** A stormwater management site plan is a comprehensive plan used to show compliance for all applicable stormwater management requirements. The stormwater management site plan is the key document in the site plan review process and used to ensure that a development has been designed and will be constructed as required. It also provides important details and certifications for the long-term ownership, operation, and maintenance of stormwater BMPs on a site.



### KEY CONSIDERATIONS

- The stormwater management site plan should be signed and sealed by a qualified design professional.
- A typical stormwater management site plan should include the following components:
  1. Natural Resources Inventory
  2. Existing Conditions Hydrologic Analysis
  3. Post-Development Hydrologic Analysis
  4. Stormwater Management System
  5. Downstream Analysis
  6. Erosion and Sediment Control Plan
  7. Landscaping Plan
  8. Operations and Maintenance Plan
  9. Evidence of Acquisition of Applicable Permits
  10. Waiver Requests (if applicable)
- The site plan review should be performed by a qualified local government staff person or consultant. The review may consist of the following steps:
  1. Pre-consultation Meeting and Joint Site Visit
  2. Review Stormwater Concept Plan
  3. Review Preliminary Stormwater Site Plan
  4. Review Final Stormwater Site Plan
  5. Pre-construction Meeting
  6. Construction Inspections
  7. Ongoing Maintenance Inspections



### 4.3.1 Introduction

To encourage and ensure that local stormwater guidelines and requirements are implemented, communities should implement a formal site plan preparation, submittal, and review procedure that facilitates open communication and understanding between the involved parties.

A stormwater management site plan is a comprehensive report containing the technical information and analysis to allow a community to determine whether a proposed new development or redevelopment project meets the local stormwater regulatory requirements. This section discusses the typical contents of a stormwater management site plan and the recommended review and consultation checkpoints between local government staff and the site developer.

The procedures and guidelines for the preparation of a site stormwater plan should be explicitly stated in a local ordinance. The ordinance, in turn, may refer to a design guidance document for additional detail. Ideally, site stormwater plans are developed with open lines of communication between the developer (and developer's engineer) and the plan reviewer. Stormwater plans are more than just the preparation of a document and maps. Instead, stormwater plans should be thought of as a process that occurs over the planning and development cycle and continues after build-out via regular inspection and maintenance of the stormwater management system.

### 4.3.2 Contents of a Stormwater Management Site Plan

The following elements are recommended components for local stormwater management site plan requirements. It is often required that a stormwater management site plan be sealed and signed by a licensed Professional Engineer or Landscape Architect.

Based on a community's prerogative, small-scale projects could be allowed to prepare a site plan that includes a defined subset of the elements outlined below.

1. Natural Resources Inventory
  - Natural Drainage Divides
  - Natural Drainage Features (e.g., swales, basins, depressional areas)
  - Wetlands
  - Water Bodies
  - Floodplains
  - Aquatic Buffers
  - Shellfish Harvesting Areas
  - Soils
  - Erodible Soils
  - Steep Slopes (i.e., Areas with Slopes Greater Than 15%)
  - Groundwater Recharge Areas
  - Wellhead Protection Areas
  - Trees and Other Existing Vegetation
  - High Quality Habitat Areas
2. Existing Conditions Hydrologic Analysis
  - A topographic map of existing site conditions (minimum 2-foot contour interval recommended) with the basin boundaries indicated
  - Acreage, soil types, and land cover of areas for each sub-basin affected by the project
  - All perennial and intermittent streams and other surface water features
  - All existing stormwater conveyances and structural control facilities
  - Direction of flow and exits from the site
  - Analysis of runoff provided by off-site areas upstream of the project site
  - Infiltration rates of existing soils
  - Methodologies, assumptions, site parameters, and supporting design calculations used in analyzing the existing conditions and site hydrology
3. Natural Conditions Hydrologic Analysis (where applicable)
  - In communities where pre-development is defined as natural conditions rather than existing conditions, or where natural conditions are a more appropriate hydrologic standard, such as discharges to impaired streams or floodprone areas, a natural conditions hydrologic analysis will be necessary. The natural conditions hydrologic analysis should include all of the elements described for Existing Conditions Hydrologic Analysis above.

- In some cases, the existing topography may not be representative of natural conditions, and the hydrologic analysis should be modified for leveling or grading that has occurred.
  - A set type of vegetative condition such as “woods in good condition” may be used in the natural conditions hydrologic analysis
4. Post-Development Hydrologic Analysis
    - A topographic map of developed site conditions (minimum 2-foot contour interval recommended) with the post-development basin boundaries indicated
    - Total area of post-development impervious surfaces and other land cover areas for each sub-basin affected by the project
    - Unified stormwater sizing criteria runoff calculations for water quality, channel protection, overbank flooding protection, and extreme flood protection for each sub-basin
    - Location and boundaries of proposed natural feature protection areas
    - Documentation and calculations for any applicable site design credits that are being utilized
    - Methodologies, assumptions, site parameters and supporting design calculations used in analyzing the existing conditions site hydrology
  5. Stormwater Management System
    - Drawing or sketch of the stormwater management system including the location of non-structural site design features and the placement of existing and proposed structural stormwater controls. This drawing should show design water surface elevations, storage volumes available from zero to maximum head, location of inlets and outlets, location of bypass and discharge systems, and all orifice/restrictor sizes.
    - Narrative describing that appropriate and effective structural stormwater controls have been selected
    - Cross-section and profile drawings and design details for each of the structural stormwater controls in the system. This should include supporting calculations to show that the facility is designed according to the applicable design criteria.
    - Hydrologic and hydraulic analysis of the stormwater management system for all applicable design storms (should include stage-storage or outlet rating curves, and inflow and outflow hydrographs)
    - Documentation and supporting calculations to show that the stormwater management system adequately meets the unified stormwater sizing criteria
    - Drawings, design calculations, and elevations for all existing and proposed stormwater conveyance elements including stormwater drains, pipes, culverts, catch basins, channels, swales, and areas of overland flow
  6. Downstream Analysis
    - Supporting calculations for a downstream peak flow analysis using the ten-percent rule necessary to show safe passage of post-development design flows downstream
  7. Erosion and Sedimentation Control Plan
    - Must contain all the elements specified in the Georgia Erosion and Sediment Control Act and local ordinances and regulations
    - Sequence/phasing of construction and temporary stabilization measures
    - Temporary structures that will be converted into permanent stormwater controls
  8. Landscaping Plan
    - Arrangement of planted areas, natural areas and other landscaped features on the site plan
    - Information necessary to construct the landscaping elements shown on the plan drawings
    - Descriptions and standards for the methods, materials and vegetation that are to be used in the construction
  9. Operations and Maintenance Plan
    - Description of maintenance tasks, responsible parties for maintenance, funding, access, and safety issues
  10. Evidence of Acquisition of Applicable Permits
  11. Waiver Requests (if applicable)

### 4.3.3 Procedure for Reviewing Stormwater Site Plans

Section 2.4 of Volume 2 describes the general procedure for the preparation of a stormwater site plan. The following steps are intended to provide communities with a review process and checkpoints that complement the procedure from the site developer's perspective:

1. Pre-consultation Meeting and Joint Site Visit
2. Review Stormwater Concept Plan
3. Review Preliminary Stormwater Site Plan
4. Review Final Stormwater Site Plan

Additional steps to ensure compliance with the stormwater management site plan include:

5. Pre-construction Meeting
6. Construction Inspections
7. Ongoing Maintenance Inspections

#### STEP 1. PRE-CONSULTATION MEETING AND JOINT SITE VISIT

The most important action that can take place at the beginning of the development project is a pre-consultation meeting between the local review authority and the developer team to outline the stormwater management requirements and other regulations, and to assist developers in assessing constraints, opportunities, and potential for stormwater design concepts.

This recommended step may help to establish a constructive partnership through the develop-

ment process. A joint site visit, if possible, can yield a conceptual outline of the stormwater management plan and strategies. By walking the site, the two parties can identify and anticipate problems, define general expectations, and establish boundaries of natural feature protection and conservation areas. A major incentive for pre-consultation is that permitting and plan approval requirements will become clear at an early stage, increasing the likelihood that the approval process will proceed more quickly and smoothly.

The site developer should be made familiar with local stormwater management and development requirements and design criteria that apply to the site. These may include:

- Design and performance standards for stormwater management
- Design storm frequencies
- Conveyance design criteria
- Floodplain criteria
- Buffer/setback criteria
- Wetland provisions
- Watershed-based criteria
- Erosion and sedimentation control requirements
- Maintenance requirements
- Need for physical site evaluations (infiltration tests, geotechnical evaluations, etc.)

This guidance could be provided at the pre-consultation meeting and should be detailed in various local ordinances (subdivision codes, stormwater and drainage codes, etc.). This information could be contained in a set of checklists, which would be provided to the developer. Appendix B includes example checklists outlining the necessary steps to prepare preliminary and final stormwater management site plans.

Current land use plans, comprehensive plans, zoning ordinances, road and utility plans, watershed or overlay districts, and public facility plans should all be consulted to determine the need for compliance with other local and state regulatory requirements. Opportunities for special types of development (e.g., clustering) or special land use opportunities (e.g., conservation easements or tax incentives) should be investigated. There may also be opportunities to partner with the site developer for the creation of greenways or open space parks.





## CASE STUDY

### City of Atlanta Stormwater Concept and Consultation Meeting

For certain types of developments, the City of Atlanta requires that a stormwater concept plan and consultation meeting be held early in the design process. At this meeting, the project's engineer and City of Atlanta staff discuss the post-development stormwater management measures necessary for the proposed project and assess constraints, opportunities, and ideas for better site design, low impact development, and runoff reduction techniques early in the design process. This consultation meeting must be held prior to submittal of an application for a building permit (BB) or land disturbance permit (LD).

Per the City of Atlanta's Post Development Stormwater Management Ordinance, the project's engineer must present a Stormwater Concept Plan to City of Atlanta staff for the following activities:

- New commercial development (greenfield) that involves the creation of any impervious cover;
- Commercial redevelopment that includes the creation, addition, or replacement of 500 square feet of impervious cover or more;
- Commercial development or redevelopment that disturbs one acre of land or more; and,
- Commercial demolition projects that leave in place more than 500 square feet of impervious cover.

The city's Stormwater Concept Plan and Consultation Meeting Record is available here: <https://www.atlantawatershed.org/green-infrastructure/stormwater-concept-plan-requirements-and-meeting-record/?showMeta=2&ext=.pdf>

## STEP 2. REVIEW STORMWATER CONCEPT PLAN

During the concept plan stage the site designer will perform most of the layout of the site, including the preliminary stormwater management system design and layout. The stormwater concept plan allows the design engineer to propose a potential site layout and gives the developer and local review authority a “first look” at the stormwater management system for the proposed development. The stormwater concept plan should be submitted to and approved by the local plan reviewer before detailed preliminary site plans are developed.

It is extremely important at this stage that stormwater design is integrated into the overall site design concept in order to best reduce the impacts of the development, as well as provide for the most cost-effective and environmentally sensitive approach.

## STEP 3. REVIEW PRELIMINARY STORMWATER SITE PLAN

The preliminary plan ensures that local requirements and criteria are being complied with and that opportunities are being taken to minimize adverse impacts from the development.

The preliminary stormwater management site plan should consist of maps, narrative, and supporting design calculations (hydrologic and hydraulic) for the proposed stormwater management system, and should include the following elements:

- Existing Conditions Hydrologic Analysis
- Natural Conditions Hydrologic Analysis (where applicable)
- Post-Development Hydrologic Analysis
- Stormwater Management System
- Downstream Analysis

It should be demonstrated that appropriate and effective stormwater controls have been selected and adequately designed. The preliminary plan should also include, among other things, street and site layout, delineation of natural feature protection and conservation areas, soils data, existing and proposed topography, relation of site to upstream drainage, limits of clearing and grading, and proposed methods to manage and maintain conservation areas (easements, maintenance agreements/responsibilities, etc.)

## STEP 4. REVIEW FINAL STORMWATER SITE PLAN

1. The final stormwater management site plan adds further detail to the preliminary plan and reflects changes that are requested or required by the local review authority. The final stormwater site plan should include all of the revised elements from the preliminary plan as well as the following items:
  - Erosion and Sedimentation Control Plan
  - Landscaping Plan
  - Operations and Maintenance Plan and Agreement (see Section 5.2 and Appendix D)

- Evidence of Acquisition of Applicable Local and Non-local Permits
- Waiver Requests

This process may be iterative. The reviewer should ensure that all submittal requirements have been satisfactorily addressed and permits, easements, and pertinent legal agreements (maintenance agreements, performance bond, etc.) have been obtained and/or executed.

The completed final stormwater site plan should be submitted to the local review authority for final approval prior to any construction activities on the development site. Approval of the final plan is the last major milestone in the stormwater planning process. The remaining steps are to ensure that the plan is installed, implemented, and maintained properly.

## STEP 5. PRE-CONSTRUCTION MEETING

This step ensures that the contractor, engineer, inspector, and plan reviewer can be sure that each party understands how the plan will be implemented on the site. A pre-construction meeting should occur before any clearing or grading is initiated on the site. This is the appropriate time to ensure that natural feature protection areas and limits of disturbance have been adequately staked and adequate erosion and sediment control measures are in place.

## STEP 6. CONSTRUCTION INSPECTIONS

Project sites should periodically be inspected during construction by local agencies to ensure that conservation areas have been adequately protected and that stormwater control and conveyance facilities are being constructed as designed. Inspection frequency may vary with regard to site size and location; however, monthly inspections are a good target. In addition, it is recommended that some inspections occur after larger storm events (e.g., 0.5 inches and greater). The inspection process can prevent later problems that result in penalties and added costs to developers. Example construction inspection forms are included in [Appendix C](#).

An added benefit of a formalized and regular inspection process is that it should help motivate contractors to internalize regular maintenance of sediment controls as part of daily construction operations. If necessary, a community can consider implementing a penalty system, whereby fines can be assessed and/or stop work orders issued.

A final inspection is needed to ensure that all construction conforms to the intent of the approved design. Prior to issuing an occupancy permit and releasing any applicable bonds, the review authority should ensure that: (1) temporary erosion control measures have been removed; (2) stormwater controls are unobstructed and in good working order; (3) permanent vegetation cover has been established in exposed areas; (4) any damage to natural feature protection and conser-

vation areas has been restored; (5) conservation areas and buffers have been adequately marked or signed; and (6) any other applicable conditions are being met.

Record drawings of the structural stormwater controls and drainage facilities should also be acquired by the community, as they are important in the long-term maintenance of the facilities. The review authority should keep copies of the drawings and associated documents to develop a local stormwater control inventory and data storage system. With geographic information systems (GIS) becoming more widely used, much of these data can be stored electronically.

## STEP 7. ONGOING MAINTENANCE INSPECTIONS

Ongoing inspection and maintenance of a project site's stormwater management system is often the weakest component of stormwater plans. It needs to be clearly detailed in the stormwater site plan which entity has responsibility for operation and maintenance of all structural stormwater controls and drainage facilities. Often, the responsibility for maintenance is transferred from the developer and contractor to the owner. Communication about this important responsibility is usually inadequate; therefore, communities may need to consider ways to notify property owners of their responsibilities. For example, notification can be made through a legal disclosure upon sale or transfer of property or public outreach programs may be instituted to describe the purpose and value of maintenance.

Ideally, preparation of maintenance plans should be a requirement of the stormwater site plan preparation and review process. A maintenance plan should outline the scope of activities, schedule, and responsible parties. Vegetation, sediment management, access, and safety issues should also be addressed. It is important that the maintenance plan contains the necessary provisions to ensure that vegetation establishment occurs in the first few years after construction. In addition, the plan should address testing and disposal of sediments that will likely be necessary.

Periodic inspections of stormwater management facilities should be conducted by an appropriate local agency, but these inspections should not replace the more frequent inspections required of the BMP owner. Where chronic or severe problems exist, local governments should have the authority to remedy the situation and charge the responsible party for the cost of the work. This authority should be well established in an ordinance.



There are many different types of development that impact natural site features and runoff patterns. By revising local codes, communities may be able to help conserve these site features and reduce the amount of impact a development has on the existing hydrology and topography. The Atlanta Regional Commission (ARC) offers a Community Choices Toolkit (<http://atlantaregional.com/local-government/implementation-assistance/best-practices>), which provides information for local officials on the choices available to them to create and sustain quality communities and takes many of the types of development discussed in this section into account.

In addition to having tailored ordinance language, communities should be prepared to address the different stormwater challenges that may be unique to each particular development type. The following offers a basic overview of the typical development categories and some of the more common challenges to implementing effective stormwater strategies.

#### **4.4.1. Subdivision**

A subdivision is a large parcel of residential, commercial, or industrial zoned land divided into smaller parcels, or lots, for the purpose of developing and selling the individual lots. In the Georgia Construction General Permit Program, this is referred to as a Common (Plan of) Development, which is a contiguous area where multiple, separate, and distinct construction activities will be taking place at different times on different schedules under one plan of development.

#### **Residential Subdivisions**

For some single-family detached residential subdivisions, the original owner or developer also serves as the home builder and will construct the primary infrastructure (i.e., roads, utilities, and other common improvements), including stormwater management facilities, in concert with the home construction, allowing for gradual and sequential construction, stabilization, and occupancy. However, the more common approach is for the original owner/developer to construct the primary infrastructure and sell the lots to be developed individually by others. This latter approach will not typically follow a sequential construction pattern and is often more difficult to manage in terms of erosion and sediment control and stormwater management implementation and oversight.

In all cases, the erosion and sediment control plan and the post-construction stormwater management plan for residential subdivisions should be developed for the entire plan of development. The Natural Resources Inventory (NRI) and the Stormwater Concept Plan (SCP) should be reviewed carefully, with a focus on any proposed phasing of construction or stormwater practice implementation.

#### **Industrial/Commercial Subdivisions**

The development of an industrial or commercial subdivision may be very different. While the site may be developed in a similar manner to a residential subdivision, with mass grading of all lots together, sometimes, the primary access road and utility infrastructure is built and the lots are

left untouched, or minimally disturbed, as may be needed for ancillary improvements. This allows the individual purchasers or tenants to develop a site plan customized for their intended use. However, the NRI should identify all the relevant features for the entire plan of development. The NRI should be utilized to configure the individual lot lines so as to minimize potential future impacts and for alignment of the primary access road. Likewise, the SCP should establish the strategy for managing the stormwater runoff from the roadway and, if applicable, conceptually identify potential strategies for the future development of the individual lots.

In some cases, the owner/developer of a commercial or industrial subdivision will benefit from an economy of scale and construct a stormwater management plan for full build-out of the subdivision. This will allow for a more efficient plan review and initial construction inspection, but the subsequent ESC plan review for individual parcel construction should be cognizant of the potential disturbed acreage in the contributing drainage area to the stormwater controls.

### Stormwater Strategies for Residential Subdivisions

Applying and enforcing the application of distributed stormwater BMPs in a subdivision development can be challenging. Since traditional residential subdivisions have many different owners and potentially on-going construction, it can be difficult to be sure adequate stormwater measures are being implemented appropriately. Ideally a subdivision layout would maintain natural site features as amenities and identify the most advantageous topography and soils for locating stormwater BMPs. Figure 4.4-1 represents a combined NRI and a SCP for a large mixed-use development. Based on the NRI, the SCP identifies the locations of high, medium, and low density development zones. The SCP also identifies ideal locations for the primary ‘subdivision-scale’ stormwater controls. Figure 4.4-2 represents the conceptual layout.

Generally, the NRI offers an opportunity to maximize cost-effectiveness of the stormwater strategy, and the development as a whole, by informing the overall layout of the development. The next step is to develop a SCP for each development zone in order to identify the degree to which the development achieves the goals of Standard #2: Better Site Design Practices for Stormwater Management, Standard # 3: Runoff Reduction, and Standard #4: Water Quality. The SCP for each development zone should include preliminary sizing computations to ensure that the stormwater practice locations are adequate for the development.

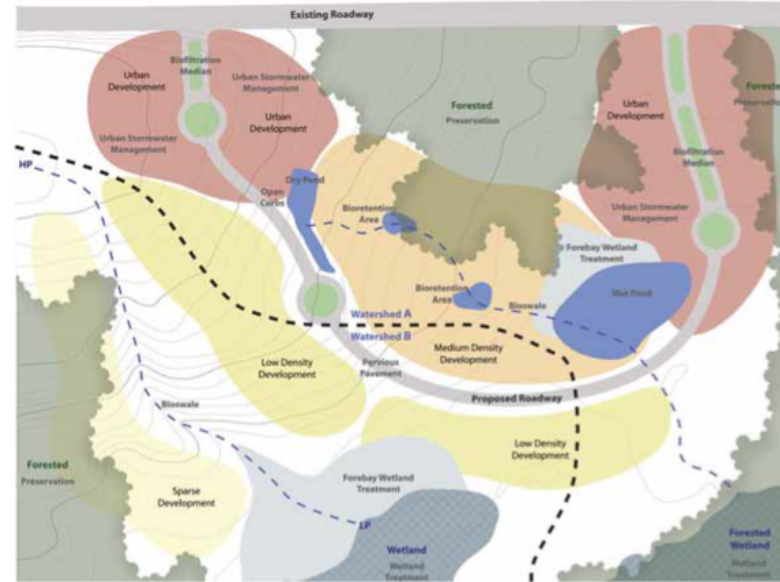

Figure 4.4-1 Schematic of a Water Quality Treatment Plan  
(Source: Central, LA Municode)



Figure 4.4-2 Final Water Quality Treatment Plan  
(Source: Central, LA Municode)



In order to review the SCP, communities should establish basic standards for acceptable better site design and water quality practices within residential subdivisions. Not all better site design strategies are consistent with local ordinances (cluster development, reduced front yard setbacks, reduced road widths, etc.). See Section 3.2 for more information about aligning local ordinances with Better Site Design Principles.

Likewise, not all water quality practices are compatible with residential subdivisions. For example, maintenance-intensive or underground practices can be difficult to manage on residential sites. Communities should establish provisions to guide the selection of subdivision-scale and micro-scale stormwater practices based on lot size (i.e., 1/2-acre lots versus 1/8-acre lot subdivisions), the presence of a Home Owners Association for establishing a single entity responsible for ongoing inspection and maintenance, and neighborhood-wide covenants related to the protection of stream buffers, proper pollution prevention, and management of open space, among other concerns. These documents are critical to long-term maintenance of stormwater infrastructure. Proper review of these documents and acceptance by the developer and future owners should be established early in the review process.

#### 4.4.2 Linear Projects

Linear development projects can include roads and highways, railroad tracks, and utility corridors, such as gas and electric transmission lines. Linear

development projects are different enough that the Georgia Department of Natural Resources developed a sector specific NPDES construction general permit: Infrastructure Construction General Permit. These projects can represent numerous design challenges for both ESC and SWM:

- The right-of-way for these infrastructure corridors is highly constrained. Public acquisition processes limit the purchase or taking of right-of-way to only that which is necessary for the primary transportation goal (meaning acquiring additional right-of-way for ancillary features such as stormwater management practices can be difficult and expensive).
- The alignment of these corridors is not flexible. Either specific topographic or public safety considerations can force the selection of the least unfavorable alignment, rather than the one that meets all the design goals;
- Alignments can form a 'levy' or diversion system, intercepting off-site areas of sheet flow and creating concentrated flow from the combined on-site and off-site drainage where it discharges from the right-of-way. Defining the specific stormwater requirements can become complicated.
- Alignments can cross several watersheds and sub-watersheds creating very complex conveyance and treatment design strategies.



Figure 4.4-3 Bioretention Area in a Subdivision  
(Source: US EPA)

Early coordination through the environmental permitting processes will typically direct these linear alignments towards minimizing impacts to regulated waters of the U.S. and private property. However, this process will likely establish design performance goals rather than the design itself, especially on new location highway projects. Primary and limited access collector widening projects and urban infrastructure upgrades are much more common and more difficult to address due to severely limited space.

Designers and plan reviewers should utilize the pre-consultation SCP process to identify and assess these challenges early in the design process to ascertain the efficacy of linear LID to the extent practicable. The Georgia Department of Transportation (GDOT) Manual on Drainage Design for Highways (<http://www.dot.ga.gov/PS/DesignManuals>) provides design guidance for linear applications of filter strips, grass channels, enhanced swales, infiltration trenches, bioslopes, sand filters, bioretention basins, and open-graded friction course BMPs. Where these practices cannot achieve full compliance, designers should consider supplemental off-site mitigation options as a viable compliance option. (Section 5.7).

#### 4.4.3. Redevelopment

Many jurisdictions actively encourage redevelopment with tax breaks, reduced impact fees, and other monetary incentives to revitalize abandoned or underutilized urban lands. Redevelopment of existing urban lands is preferred over the 'green-field' development that expands the urban area

footprint into rural areas. The desire to retrofit these redeveloping sites with stormwater controls requires a delicate balance to avoid creating a disincentive for redevelopment.

Designers and plan reviewers should utilize the pre-consultation and SCP process to identify and assess stormwater treatment options. In some cases, reductions in impervious cover can help satisfy stormwater management requirements. Designers may also evaluate the most readily managed portion of the site for treatment in order to reduce costs, rather than treating the specific area of new impervious cover. Designers should also consider off-site mitigation as a viable compliance option.

Ultimately, financial or other incentives to encourage redevelopment should take precedence over exemptions or variances to environmental protection ordinances. Other avenues to encourage redevelopment include:

- Establishing a formal infill development/redevelopment program to ensure that developers and property owners are aware of incentives, such as:
  - » Financial incentives and prioritized capital funding or financing for infrastructure improvements (water, sewer, and transportation upgrades, etc.) in identified growth areas;
  - » Housing density bonuses and accelerated permitting process for infill and redevelopment projects;

- » Reduced impact fees for infill development based on less demand for new infrastructure;
  - » Establishment of Tax Incremental Financing districts to encourage redevelopment; and
  - » More restrictive zoning, utility access, stormwater requirements, and other provisions outside of growth boundary or at the edge of a city to restrict development and preserve rural character (Nevue, 2009).
- Reviewing and revising local codes to eliminate unnecessary site infrastructure upgrades to the extent practicable; and
  - Utilizing and promoting financial incentives provided by state and federal programs to encourage redevelopment and revitalization.

More information on the advantages, opportunities, and strategies for local adoption of infill development and redevelopment and planning policies is provided in [Chapter 3](#) of the Manual.



Figure 4.4-4 Linear Bio-swale  
(Source MDSHA)

#### 4.4.4. Single Family Homes

Single family home construction that is not part of a common plan of development is usually exempt from stormwater management requirements.

However, the cumulative effect of many new homes and/or large additions can result in changes to the hydrologic conditions of a developing area. Some guiding principles can be applied to individual building permits to help property owners and general contractors minimize impacts as well as the potential for ongoing drainage problems:

- Provide educational materials with building permits to clearly illustrate proper implementation of pollution prevention and ESC measures;
- Ensure adequate grading and drainage around the house foundation and other improvements without creating concentrated flow, which can include the use of level spreaders or impervious disconnection at downspouts; and
- Review soil conditions and make property owners aware of permeable soils for directing downspout and sheet flow, or the implementation of rain gardens, dry wells, permeable pavers, and other BMPs.



Figure 4.4-5 Residential Rain Barrel  
(Source: www.energyearth.com)



### CASE STUDY

#### City of Atlanta Single-Family Development Requirements

In February 2013, the City of Atlanta amended its Post-Development Stormwater Management Ordinance to require green infrastructure on new and redevelopment projects in the City. Atlanta's ordinance is unique in terms of its applicability to single-family development.

The City's previous requirements allowed 99% of homes to be constructed in existing neighborhoods without any form of stormwater management. The City now requires new homes and large additions (>1,000 ft<sup>2</sup> of impervious surface) to manage the first 1.0" of runoff on their site using green infrastructure.

With the help of a consultant, the City developed a guidance document, Green Infrastructure for Single Family Residences, which specifies the types of stormwater practices that can be utilized on an individual lot, allows the user to size the practice using easy to read sizing charts and provides tear-off detail sheets that show a step-by-step construction sequence for the given practice. The practices include routing runoff from the roof to a simplified rain garden, dry well, modified French drain, cistern, or natural buffer.

The guidance document is available here: <https://www.atlantawatershed.org/greeninfrastructure/atlanta-residential-gi-nov-2012022013/?show-Meta=2&ext=.pdf>

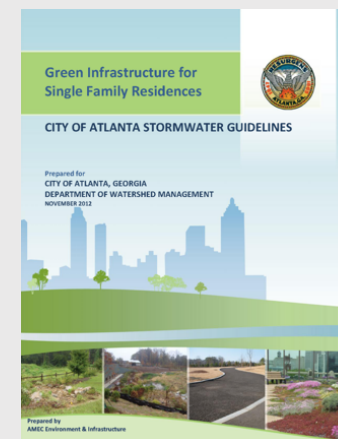

Figure 4.4-6 City of Atlanta's Green Infrastructure for Single Family Residences Manual

Source: Rayburn, Rutherford, Implementing Green Infrastructure: Atlanta's Post-Development Stormwater Ordinance, City of Atlanta Department of Watershed

#### 4.4.5. Planned Unit Development

According to the American Planning Association, a planned unit development (PUD) is a large, integrated development adhering to a comprehensive plan and located on a single tract of land or on two or more tracts of land that may be separated only by a street or other right-of-way. Establishing PUD districts can enable the building of innovative new developments, while preserving natural features and open spaces.

PUDs offer a comprehensive approach to the design of large scale developments, as opposed to the conventional lot-by-lot approach typically allowed in community zoning codes and regulations. Unlike conventional development, a PUD allows developers to by-pass standard zoning and development regulations in exchange for site-specific design and development innovations, such as clustered lots, mixed land uses, conservation of open spaces, and natural resource preservation (Ellis, 2014).

These considerations offer a potentially unlimited list of options to creatively and holistically manage stormwater. Specific strategies can be applied to different areas or phases of the development. Regional or subdivision-scale practices can be supplemented with micro-scale practices distributed throughout the development on outparcels or individual lots.

The zoning approval process for PUDs typically involves many rounds of negotiation. Any commitments regarding stormwater management made during these negotiations, including any restrictive covenants or shared responsibilities for the stormwater infrastructure, should be clearly documented and passed forward to the stormwater program plan review staff. The pre-consultation and SCP process should incorporate these provisions into the final construction drawings, accompanied by detailed HOA and common area restrictive covenants and maintenance agreements.



## CASE STUDY

### Planned Unit Development: Palmetto Bluff, SC (Ellis et al, 2014)

Palmetto Bluff, South Carolina is a sea island with expansive frontage on the May, Cooper, and New Rivers. For most of the last century, Palmetto Bluff has been managed and enjoyed as a private wildlife and forest preserve. The property has been carefully master-planned to grow into a complete, balanced, and controlled community within a coastal setting. Its size makes possible the creation of a series of inter-related, yet distinctive, settlements and natural preserves. The combination of its location and varied natural features makes this a unique community.

Palmetto Bluff has been designed to preserve the land's beauty, vastness, and rich landscape, while taking advantage of the views and island setting to create a strong sense of place. Owners, along with their architect and landscape architect, are encouraged to work together from the initial phases of design to ensure that all aspects of the design are consistent with specific design objectives, such as implementing sustainable building systems, site development, materials, and construction techniques in all development. Reducing consump-

tion of materials and energy, reducing waste, and making intelligent choices about how a building is used benefits both Palmetto Bluff as a community and the sensitive sea island landscape as a whole. Palmetto Bluff is committed to the implementation of Sustainable and Low Impact Design concepts, such as reducing the house's "footprint" on the land, implementing energy and water conservation measures, reuse and recycling of building materials, and preservation of the existing forest and river marsh frontage.

The text for the Palmetto Bluff Planned Unit Development is based on the Beaufort County Zoning and Development Standards Ordinance 90/3 with the following amendments:

- River Protection Overlay District
  - » The buffer width was changed from fifty (50) feet to an average of one hundred (100) feet, with a minimum of eighty (80) feet.
  - » Development setbacks changed from fifty (50) feet to an average of one hundred (100) feet, with a minimum of eighty (80) feet. Additionally, streets and roads to access land

within the PUD can penetrate the buffer provided stormwater runoff is treated.

- Site Design and Development Standards
  - » In the planned resort, residential and commercial development parking requirements were changed for the following uses. The assumption underlying the change was that a substantial number of visitors would arrive by public transportation, thus requiring fewer spaces than the current requirements.
    - Auditorium and Theaters: 0.2 spaces for each spectator seat.
    - Automobile Service Station: One (1) space for each vehicle stored or parked, plus one (1) space for each employee.
    - Bank: One (1) space for each two-hundred square feet (200 sf) of gross floor space, plus one (1) space for each two (2) employees.
    - Church: One (1) space for each six (6) seats in the main assembly room.

## References

City of Atlanta. 2013. *Stormwater Concept Plan and Consultation Meeting Record*. City of Atlanta, Atlanta, GA.

Ellis, K., C. Berg, D. Caraco, S. Drescher, G. Hoffmann, B. Keppler, M. LaRocco, and A. Turner. 2014. *Low Impact Development in Coastal South Carolina: A Planning and Design Guide*. ACE Basin and North Inlet – Winyah Bay National Estuarine Research Reserves.

Nevue Ngan Associates, Eisen|Letunic, Van Meter Williams Pollack LLP, ICF International. 2009. *Stormwater Management Handbook: Implementing Green Infrastructure in Northern Kentucky Communities*. ICF International. Fairfax, Va. Nevue Ngan Associates. Portland, OR.

Rayburn, Cory, Susan Rutherford. 2014. *Implementing Green Infrastructure: Atlanta's Post-Development Stormwater Ordinance*. City of Atlanta Department of Watershed Management, Atlanta, GA.



## 5. Elements of Stormwater Management Programs

### 5.1 Site Plan Review and Enforcement

Description: A formal stormwater management site plan review process is important to ensure that local stormwater guidelines and requirements are implemented.

#### KEY CONSIDERATIONS

Roles of Interested Parties in the Site Plan Review Process:

- Local Program Authority – Establish post-construction stormwater management requirements, develop and facilitate an effective stormwater design and plan review process, and evaluate program regularly.
- Design Engineer – Understand local requirements and communicate design options and life-cycle implications to client and local program authority.
- Local Plan Reviewer – Ensure that stormwater management plans meet the standards and specifications of applicable permits and ordinances.

The Site Plan and Construction Review Process should include the following:

1. Design and Review Materials
2. Pre-Design or Pre-Submittal Consultation Meeting
3. Stormwater Management Concept Plan
4. Final Stormwater Management Design and Construction Plans and Computations
5. Land Disturbing Permit and Transfer Project to Inspection and Maintenance Personnel
6. Pre-Construction Meeting
7. Construction Inspection and As-Built Record Drawings



### 5.1.1 Introduction

To encourage and ensure that local stormwater guidelines and requirements are implemented, communities should implement a formal stormwater management site plan submittal and review procedure. The basic steps in the review process should be outlined and the appropriate contact information for purposes of communicating approval, or disapproval when necessary, with corresponding written comments should be identified.

A stormwater management site plan is a comprehensive report that contains the technical information and analysis to allow a community to determine whether a proposed new development or redevelopment project meets local stormwater regulatory requirements. The introduction of Better Site Design (BSD) and low impact development (LID) practices that reduce impervious surface and infiltrate as part of the stormwater management strategy complicate the design review and change the methods in which land-disturbing activities are undertaken. Typical development projects often fit the landscape to the development, but with implementation of BSD and LID, the goal is the opposite – fit the development to the natural landscape. The conceptual approach to designing with BSD and LID should occur at the earliest stages of the design and review process, including zoning applications and preliminary plan approvals.

This section discusses the recommended roles and responsibilities of the local government staff

plan reviewer and the applicant (or more likely the applicant's designated agent – the design engineer), as well as consultation checkpoints through the plan review process.

### 5.1.2 Roles of the Local Program, the Local Plan Reviewer, and the Design Engineer

The technical criteria, performance goals, accepted best management practices (BMPs), and associated hydrologic and hydraulic computational methods upon which the stormwater management plan must be based should be explicitly spelled out or adopted by reference in the local ordinance. However, the design steps, calculations, and modeling tools that the design engineer utilizes for demonstrating compliance may vary from engineer to engineer and/or from site to site. Complex commercial projects may utilize a robust package of integrated design and CADD software, while small single family lot subdivisions or similarly simple developments may use of a more modest design package.

In either case, it is the role of the local program to establish and communicate clear expectations and minimum design criteria. It is the role of the design engineer to understand the local requirements and work with his or her client to incorporate these into the site and stormwater management design strategy with the necessary documentation and clearly communicate the strategy to the plan reviewer. And finally, it is the role of the plan reviewer to ensure that all the

required elements of the design and construction drawings are present and that they collectively demonstrate compliance with the standards and specifications in the ordinance and design manual.

The following should be considered general guidance to help the local program authority, design engineer, and plan reviewer navigate the various responsibilities necessary for bringing a project from the preliminary planning stage to construction.

#### The Role of the Local Program Authority:

To facilitate effective stormwater design and plan review processes, the local program authority should consider the following recommendations:

- Set clear and concise goals for integrating better site design and low impact development strategies into stormwater management designs.
- Establish processes for stormwater management strategies to be incorporated early in the planning process (e.g., zoning, preliminary plan) and carried forward through subsequent steps in the development approval process.
- Establish routine pre-design, pre-submittal process to review the site conditions and discuss opportunities for conserving natural resources, minimizing impervious surface, and using LID best management practices.

- Develop standard procedures for applicants to propose innovative designs for challenging sites. Development projects will often present unique conditions that could not have been foreseen in the development of specific design standards. A review process that establishes minimum performance goals and recommended steps for demonstrating compliance will often encourage innovative and effective design strategies.
- Sponsor periodic combined training workshops for plan review staff and the local design community to foster communication and understanding of the different site design issues and challenges, and support a better understanding of acceptable implementation strategies.
- Develop design, submittal, and review checklists to foster consistency in the design documentation and review process. Example site plan review checklists can be found in [Appendix B](#).

More detailed information for site plan review is available in *Managing Stormwater in Your Community Chapter 7, The Stormwater Plan Review Process* (CWP, 2008).

#### The Role of the Design Engineer:

- Understand local requirements and represent his or her client's interests in developing a compliant stormwater management strategy that minimizes adverse post-development stormwater runoff impacts from the development.

- New stormwater management objectives and performance goals, such as better site design and runoff reduction, are being added to the traditional site planning process. The design engineer should strive to understand these objectives, identify consistencies with his or her client's site design objectives, and incorporate them into the overall site plan.
- Meet with the local plan reviewer prior to beginning design in order to discuss site constraints and opportunities for implementing BSD and LID practices. Do not rely on plan review comments to identify best fit strategies or specific requirements.

Communicate design options and life-cycle implications to the client and the local plan review authority. Some LID strategies can be relatively inexpensive to build and may or may not represent an ongoing maintenance responsibility for the post-construction owner of the property. Alternatively, other BMPs may be expensive to build but the shared responsibility of maintenance can be relatively minor. In all cases, the engineer should ensure that their client is aware of these options and develop appropriate long-term maintenance documentation to be included in the design submittal.

- Conduct site visits to verify field conditions.
- In most cases the design requirements include a soils investigation, depth to groundwater, wetlands, and other formal site assessments. However, the design engineer should also visit the site and verify any pre-developed conditions related to site hydrology, vegetation,

topography, and any other conditions relevant to the stormwater design. Consider site designs that maintain a portion of the site in a natural, undisturbed condition, particularly environmentally sensitive landscapes such as wetlands and stream buffers.

- Clearly communicate the design and supporting computations to the plan reviewers. Stormwater management designs can be complex with LID practices in series (or "treatment train") with structural stormwater treatment practices and/or peak rate detention practices. These designs require that reductions in runoff volume, pollutant loads (in some watersheds), and peak rate of flow be tracked through multiple drainage areas and stormwater practices. Engineers should consider the use of a design narrative, node diagrams, and other documentation strategies to facilitate review of the design.
- In general, design engineers should follow the Fundamental Canons of the Professional Engineer, especially:
  - » Hold paramount the safety, health, and welfare of the public; and
  - » Perform services only in areas of their competence.

Further, the National Society of Professional Engineers' Professional Obligations encourages engineers to "adhere to the principles of sustainable development in order to protect the environment for future generations."

“Sustainable development” is the “challenge of meeting human needs for natural resources, industrial products, energy, food, transportation, shelter, and effective waste management, while conserving and protecting environmental quality and the natural resource base essential for future development.” National Society of Professional Engineers Code of Ethics; <http://www.nspe.org/resources/ethics/code-ethics>

#### The Role of the Local Plan Reviewer:

The role of the local plan reviewer can be summed up as that of ensuring that stormwater management plans meet the standards, specifications, and performance criteria in the ordinance, applicable permits, and design manual, and that BMPs are being properly applied to the project site.

- Determine if the stormwater management plan adequately addresses the standards and specifications in the ordinance and design manual.
- Understand the requirements and the difference between requirements and guidelines.
- Offer suggestions where appropriate, but do not re-design the plan.
- Ask questions: Stormwater plans and computations can be complex. Plan reviewers may not recognize the thought process and intent of design elements or the computational methods, especially given the numerous hydrologic and hydraulic software packages available.

- Reserve the right to get smarter: Comments on the first submission may lead to new comments on the second submission, or it may be that not everything was noted on the first review. In either case, reviewers should strive to identify all comments on the first review, but should not be restricted to assessing first review comments only in subsequent plan submissions.
- Attend the pre-construction meeting with the contractor, engineer, and inspector to ensure that each party understands the essential elements of the stormwater management plan, including locations for LID installation and conserved natural areas that should not be disturbed.

#### 5.1.3 Site Plan Review Process

The recommended standards of the stormwater management plan can be found in [Section 4.2](#).

The detailed review of the plan and computations will determine if the design adequately meets local stormwater management technical requirements. This section provides a recommended stepwise process for reviewing plans and computations to ensure compliance, while also fostering multi-disciplinary and innovative design strategies ([discussed in more detail in Section 5.1.4](#)).

All plan submittal stages should include a Submittal Completeness Checklist to ensure that the submittal package is reviewable. This is not a determination of the adequacy of the design in meeting the requirements, but rather it is used to confirm that all required parts of a complete stormwater management design are included. All stages of plan review should also include written

documentation of comments. This can be in the form of an itemized list of questions or comments, or a marked-up plan set.

#### 1. Design and Review Materials

The regulated community should have the same plan review checklists as the plan reviewers, including the following:

- Submittal application or transmittal form with applicant information;
- Checklists – including Design, Submittal Completeness, and Review checklists – for each stage of the review process ([see Section 4.3.2 for Contents of a Stormwater Management Site Plan](#));
- Review process and schedule information; and
- Contact information for relevant personnel.

#### 2. Pre-Design or Pre-Submittal Consultation Meeting

- The regulatory criteria and ordinance language rarely accounts for all varieties of site conditions and development scenarios encountered in the land development process. This is especially true if the project will consist of multi-disciplinary and/or innovative compliance strategies. A pre-design meeting with a site visit allows the design team to identify site-specific issues and review potential design strategies with the local plan review personnel. In general, this step will lead to better designs and preliminary understanding of the expectations, which in turn results in a faster review and approval process.

### 3. Stormwater Management Concept Plan

The stormwater concept plan articulates the basic design strategy to the design and review team. Similar to the Pre-Design Consultation Meeting, this is a critical step for plans that will include multi-disciplinary and/or innovative compliance strategies, as it allows the opportunity to coordinate with staff who might be reviewing other components of the site plan or subdivision plat. The local plan review staff can provide preliminary feedback before the applicant spends time and resources preparing more complex engineered plans and computations.

A general checklist of recommended items should include preliminary hydrologic computations (e.g., impervious area anticipated, preliminary pre- and post-runoff volumes). This can be especially important if multiple stormwater practices will be utilized in series or treatment train; the design engineer can provide basic node diagrams or other graphics to help convey the strategy.

### 4. Final Stormwater Management Design and Construction Plans and Computations

This stage includes several items that should be identified in the Final Design Submittal Completeness Checklist (plan review application and fees, project narrative, stormwater management and erosion and sediment control construction drawings, hydrologic and hydraulic computations, draft stormwater management practice maintenance agreements, certification statement (Professional Engineer, or registered Landscape Architect or Land Surveyor as appropriate), etc.

This is likely an iterative process; however, with a pre-design consultation meeting and a concept plan review, two review cycles should be sufficient. The submittal completeness checklist should require a sufficient number of plans and computations to route a review plan set to the appropriate sister agencies (i.e. the transportation, water, and sewer departments) and all review letters should be consolidated into a single transmittal response.

### 5. Land Disturbing Permit and Transfer Project to Inspection and Maintenance Personnel

Issuance of a local land disturbing permit should be predicated on all local approvals having been obtained, including erosion and sediment control (if review and approval is independent of the stormwater design review). Also, final documentation or proof of other permits, (Army Corps of Engineers Section 404 and/or state stream and wetland permits, NPDES construction general permit, stream buffer variance (if applicable), etc.), should be provided.

In addition, any construction bonds or surety for erosion and sediment control, BMP construction, and any other improvements should be calculated based on the approved plans and posted.

Finally, stormwater BMP inspection and maintenance agreements, maintenance access easements, and conservation easements (if applicable), as reviewed and approved during the plan review process, must be signed and recorded.

The last step is to verify that all the appropriate information is transferred to the Inspection and Maintenance Teams:

- Project information: name of project, location, file or tracking number, file location
- Plan reviewer contact information
- Information from stormwater plan: number, type of practices (structural and nonstructural), and location
- Copy of any stormwater credits applied to site
- Copy of plat showing drainage and access easements and any deeds of easement
- Copy of recorded long-term inspection and maintenance agreement denoting responsible party
- Performance bond form and computation sheet
- Copy of other relevant permits (streams, wetlands, floodplains, and dam safety)

## 6. Pre-Construction Meeting

The pre-construction meeting ensures that each party (contractor, engineer, inspector, and plan reviewer) understands how the plan will be implemented on the site. A pre-construction meeting should occur before any clearing or grading is initiated. The local inspection team should meet with the 'site operator' and the designated 'certified personnel' to discuss the project and ensure that natural feature protection areas and limits of disturbance have been adequately staked and that sufficient erosion and sediment control measures are in place before any land disturbance occurs (other than that needed for implementation of erosion control measures).

The inspection team should also review the requirements for stormwater BMP construction and establish critical milestones that will require inspections. For example, infiltration BMPs must be protected from compaction and sedimentation during construction of other portions of the site. Additional information regarding inspections is provided in [Section 5.1.5](#).

## 7. Construction Inspection and As-Built Record Drawings

Once construction begins, construction inspections should be performed periodically to confirm that required stormwater management plan elements are properly located and constructed. Once construction is complete, "as-built" documentation should be submitted so the county

has a record of all stormwater BMPs on the site (construction inspection is discussed further in [Section 5.1.5](#)).

### 5.1.4 Multidisciplinary Approach to Stormwater Management

Stormwater management treatment objectives have evolved significantly from the early years of peak rate control for flood protection through the range of targeted design storms for natural channel protection, and into the recent years of targeted stormwater runoff pollutant removal. The current regulatory epoch is focused on all of these goals through runoff volume reduction as the surrogate treatment objective and replicating the pre-development hydrologic cycle on development sites as the performance goal. These strategies will require a multi-disciplined approach to site design starting at the earliest stages of the development process. For example, a landscape architect may be better able to assist with some better site design principles and vegetation-based BMPs, such as bioretention.

The various better site design strategies that can be considered self-crediting through the resulting reduction in impervious cover include:

- Cluster or compact development that leaves portions of the property undisturbed
- Local subdivision street acceptance (roadway design, pavement width, curb and gutter section versus open section, sidewalks, etc.)

- Reduced parking requirements
- Reduced building setbacks
- Impervious cover limitations

These impervious cover reduction strategies are typically contingent upon locally administered zoning, subdivision, and other land use ordinances (additional information on these can be found in [Chapter 3](#)).

Other site design strategies may serve as BMPs; however, multi-disciplinary design and plan review/approval steps may be warranted for the following:

- Vegetated buffers
- Natural area conservation
- Stream buffers
- Improved soils management

The first step in the review process is to determine if any additional documentation of agreements, special conditions, and other correspondence that originated from the earliest days of the project is required. For example, documentation of conservation easements to maintain land set aside from development in perpetuity should be documented and included for review as necessary. These early process stages are where site design elements are introduced as ways of ensuring compliance with local resource protection initiatives above and beyond stormwater management requirements.



### 5.1.5 Enforcement

An enforcement program consists of regular inspections during construction as well as periodic (ongoing) operation and maintenance inspections at regular intervals after construction. Ensuring that the post-construction stormwater practice is built correctly (in accordance with the approved plans) and that the contributing drainage area is stabilized is critical to the initial and long-term performance of the practice. This section focuses on construction inspections, and [Section 5.2](#) addresses the periodic (ongoing) operation and maintenance inspection program.

Stormwater BMP construction inspections ensure that:

- The approved erosion and sediment control plan is implemented and effective;
- Structural and non-structural stormwater practices are built in accordance with the approved stormwater management plan;
- Better site design and LID strategies are properly implemented (e.g., areas of the site shown on the plan to be preserved are not disturbed during construction);
- As-built record drawings include inspection documentation of critical milestones of BMP construction; and
- Final permanent stabilization is achieved, such that the stormwater BMPs are functional prior to releasing bonds or terminating the

permit (this final inspection should also verify the removal, as appropriate, of any remaining erosion control measures, that conservation areas and buffers have been protected and adequately marked or signed, etc.).

BMP construction inspection frequency may vary with regard to the particular type of BMP. Some BMPs, particularly those with underground elements, will require more frequent inspections, while surface BMPs will require fewer. It is also recommended that some inspections occur after larger storm events (e.g., 1/4" or 1/2" and greater). The inspection process can prevent later problems that result in penalties and added costs to developers.

Local ordinances will dictate the frequency of local erosion and sediment control inspections, while the frequency of self-inspections conducted by the site operator's designated certified personnel is dictated by the construction permit. General guidance on erosion and sediment control inspections conducted by local program inspectors and required self-inspections conducted by the site operator's designated certified personnel can be found in the Manual for Erosion and Sediment Control in Georgia.

The complexity of BSD and LID strategies in terms of timing of construction makes for a very complex erosion and sediment control plan. Multiple site design strategies that must be installed after the contributing drainage areas are stabilized

require careful phasing of site grading and stabilization efforts to control runoff on-site while transitioning to final conditions. An important goal of local program inspections and self-inspections is to ensure compliance with the sequence of construction. The sequence of construction is critical for ensuring that site conditions are adequate for the staged installation of multiple permanent Post-Construction BMPs. The erosion and sediment control plan should include specific requirements governing the construction of the stormwater BMPs (e.g., transitional drainage pattern and stabilization requirements) and conversion to the final layout once the practice has been completed.

BMP construction inspections should also be coordinated to the extent possible to allow inspection at the critical milestones of construction. These will vary by BMP, but generally include the following:

- Grading for post-construction BMPs
- Modifications to embankments, risers, and spillways
- Construction of forebays or pretreatment cells
- Placement of underdrain systems
- Testing and installation of soil or filtering media
- Planting, final grading, and final stabilization

Basic Stormwater Construction Inspection Checklists that can be customized to meet local requirements can be found in [Appendix C](#).

The inspection team should review the proposed BMPs with the site operator and/or certified personnel at the pre-construction meeting and coordinate contact information and lead times to facilitate quick response when critical construction milestones are approaching. The inspection team should encourage contractors to take photographs before, during, and after construction to help document the process and provide evidence that BMPs have been properly constructed. The inspection process should also include:

- Clear communication of any corrective actions required to address deficiencies in BMP construction;
- The time allotted for the completion of the corrective action; and
- Follow-up inspection documenting that the action has been successfully completed.

The effectiveness of the construction inspection process will be an important factor in the long-term performance and community acceptance of better site design and low impact development strategies. Documentation of inspections and any corrective actions required should be maintained in the project file.

As-built plan submittals represent the final tool a local enforcement program has to ensure that all BMPs were constructed properly on a site. Upon completion of a project, and before a certificate of occupancy is granted, the applicant should be required to certify that the completed project is in accordance with the approved stormwater management plan. The plan should show the final design specifications for all stormwater management facilities and practices and be certified by a Professional Engineer.

When the bond is released, or a certificate of occupancy is granted, the updated owner's contact information should be required of the developer so that the long-term maintenance program can properly update their files. Without updated contact information it is extremely difficult for the local government to ensure the BMP is properly maintained.

## 5.2 Operation and Maintenance

**Description:** A comprehensive long-term BMP inspection and maintenance program is essential to ensuring that the water quality and peak flow reduction benefits achieved from BMP installation are maintained over time.



### KEY CONSIDERATIONS

- A community needs to consider what level of involvement they plan to have in the maintenance of privately-constructed BMPs.
- The types of BMPs constructed in a community will greatly affect future maintenance needs.
- Maintenance needs can be reduced or simplified through thoughtful design of BMPs.
- The requirements and components of the inspection and maintenance program should be identified with clear legal authority in a local ordinance.



## 5.2.1 Introduction

One of the most important measures of a successful stormwater program is the total lifecycle cost effectiveness of the accepted stormwater practices. The question is not whether a local stormwater system maintenance program is necessary; rather, the question is how the community's maintenance program will be budgeted, staffed, and administered, and who has responsibility for scheduling and conducting inspections, carrying out routine maintenance, and funding corrective and/or non-routine maintenance. Local governments have been implementing stormwater programs for many years now, providing numerous examples of the benefits of addressing these long-term operations and maintenance questions proactively. Incorporating long-term maintenance provisions into each of three phases of local stormwater management program implementation will help to achieve the desired water quality benefits at the lowest life-cycle cost for property owners and local governments:

### 1. Local ordinance and design guidance.

The local ordinance and accompanying stormwater Best Management Practice (BMP) design guidance should clearly emphasize the long-term inspection and maintenance features that ensure maximum performance and lifecycle cost effectiveness of the BMPs (i.e., addressing issues related to complex construction phasing, adequate erosion control while vegetation is established, and requiring maintenance related accommodations in the BMP design).

2. **Local construction inspection program.** Successful construction of what can be a complex design strategy depends on the ability of contractors to understand the design and to orchestrate BMP construction phasing and timing amid all the other moving parts of a construction site (i.e., small structural and non-structural BMPs being implemented only after the contributing drainage areas have been stabilized). The local construction inspector is therefore a critical part of ensuring long-term performance through compliance with the approved plans and properly performing BMPs.
3. **Local long-term inspection and maintenance program.** The long-term inspection and maintenance program ensures that the cost and effort to design and construct the stormwater strategy yields the intended long-term water quality benefits. The local program should utilize multiple avenues to engage property owners and encourage (and enforce when necessary) compliance with owner-inspection and routine maintenance requirements, while also performing the responsibilities reserved for the local program.

This section covers the local government long-term inspection and maintenance program, which is the third leg of a cost-effective local stormwater program.

Challenges and concerns related to the implementation of a stormwater system inspection and maintenance program have not changed. While stormwater management strategies and BMP designs have evolved to recognize the importance of LID and runoff reduction, communities must still make decisions concerning which parts of the stormwater management infrastructure should be the local government's responsibility and which parts, if any, can be successfully delegated to the private property owner. When these questions are not addressed and communicated to the community, maintenance is often neglected, and the drainage and stormwater system can gradually fall into disrepair until flooding or another form of system failure forces a reaction (that likely costs orders of magnitude higher than regular maintenance).

The challenges associated with the development and implementation of an effective maintenance program include (CWP 2006):

- Lack of definition of the 'stormwater system'
- Lack of an awareness of 'ownership' and accompanying maintenance responsibilities
- Lack of funding
- Inability to track responsible parties
- Lack of dedicated inspection staff
- Designs that are not conducive to easy maintenance

- Lack of compliance and enforcement authority
- Lack of simple tests to determine BMP effectiveness
- Varying set of regulations applied to the BMPs, based on the permitting date.

While any one or a combination of these challenges can quickly undermine the implementation of a maintenance program, the most important item is the initial definition, inventory, and map to serve as the foundation for development of a successful program. Knowledge of the existing system and the qualifying characteristics of the future system becomes the basis for identifying and assigning long-term roles and responsibilities for the maintenance program and level of service.

### 5.2.2 Low Impact Development Maintenance

As discussed in [Chapter 1](#), there is a growing body of evidence that the traditional stormwater management strategies (i.e., peak flow attenuation) may not be as effective in protecting receiving stream channels and aquatic resources as was once believed. These traditional strategies combined with traditional urban drainage conveyance systems (curb and gutter, drainage inlets, pipes, etc.) do not address impacts associated with increased volume, duration, and frequency of peak discharges from urban areas or the loss of stream baseflow and groundwater recharge. Alternatively, LID that encourages infiltration and runoff volume reduction through distributed small-scale storm-

water management practices is generally considered to be more protective of water quality and receiving stream health (NAS, 2008).

A challenge for local programs is identifying how to address long-term inspection and maintenance of this new type of infrastructure. This challenge is compounded by the application of these strategies for residential development. Traditional inspection and maintenance program requirements are too cumbersome for community-wide application of distributed small-scale practices. The reflex reaction to this potential expansion of the administrative burden of traditional BMP tracking and inspection protocols is to restrict LID as part of the compliance strategy, especially when proposed on residential developments with small-scale BMPs distributed throughout the development, including individual lots.

Low impact development will increase the number of BMPs above what would be expected from traditional strategies. The perception is that the increase in the number of practices will translate into a corresponding increase in the inspection and maintenance resources needed to administer the program, thereby creating a barrier to implementation of LID (Houle et al. 2013).

However, it is important to note that LID practices are small and generally less complex than traditional centralized (subdivision) scale BMPs and should therefore require less time to perform routine inspections (i.e., a lay-person's observa-

tions of general landscaping and standing water). Alternatively, a traditional centralized BMP may require qualified inspections of (1) the embankment for stability and seepage; (2) the riser/outlet for structural integrity; (3) the riser-barrel (principal spillway) connection for water tightness; (4) the outlet for signs of scour; and (5) the overall storage volume area for excessive sedimentation.

Likewise, routine maintenance of LID may be more frequent in order to support the often highly visible locations, but this maintenance is generally less complex, consisting of routine landscaping and trash removal activities versus the often reactive maintenance required of traditional centralized structures. This is often a hypothetical debate based on anecdotal experience with failed stormwater systems. However, LID and distributed small-scale stormwater strategies are shown to be cost-effective: a recent study (Houle et al. 2013) compared the maintenance burden as measured by cost and personnel hours of LID and traditional practices and determined that:

1. LID practices have lower annualized maintenance costs based on acres treated (see Figure 5.2-1); and
2. LID practices have lower marginal maintenance costs in terms of mass pollutant load reductions: ranging from \$4–\$8/kg/year TSS removed for porous asphalt, a vegetated swale, bioretention, and a subsurface gravel wetland, to \$11–\$21/kg/year TSS removed for a wet pond, a dry pond, and a sand filter system.

LID practices not only represent a viable treatment strategy for compliance on new development projects, but also can be very practical for stormwater retrofitting of large residential areas for total maximum daily load (TMDL) compliance. As local program plan reviewers and construction inspection personnel gain experience with these strategies, there will be lessons learned and improved efficiencies in the administration and implementation of inspection and enforcement programs on residential lots.

In general, the challenges, complexities, and administrative burden of an inspection and maintenance program geared toward small-scale distributed BMPs are related to data management, which can be addressed through improved information technology and assertive community outreach programs.

### 5.2.3 Components of an Inspection and Maintenance Program

The stormwater drainage infrastructure of many urban areas consists of varying sizes of concrete pipes, channels, and other features that were designed to effectively convey the peak runoff away from built infrastructure – roads, sidewalks, parking lots, and commercial and residential structures. These systems have been and continue to be designed, to the extent practical, to be durable and relatively easy to maintain; minimum hydraulic design criteria ensure that the flow velocity keep the system clear of debris and the system, in general, has a long design life.

In more recent years, stormwater management systems have been designed to perform in an almost opposite manner: detaining peak flows in order to protect downstream receiving stream channels from damage associated with increases in peak discharge from new impervious cover. These flow attenuation facilities include large storage volumes and flow control structures that are designed to require minimal maintenance (flow controls with trash racks that shed debris, outlet channel armoring to minimize scour, etc.). Periodic vegetation management has become an accepted element of maintenance. Removal of sediment, structural repairs to the flow control structure, and/or geotechnical investigations of the embankment occur so infrequently that owners often have no first-hand experience with the responsibilities associated with ownership of these facilities.

Most recently, design treatment objectives and performance goals have evolved further to include varying scales of LID. This ‘watershed’ change in the stormwater management paradigm adds a new and beneficial level of stormwater infrastructure performance. However, the added water quality benefits come with a tradeoff. With smaller, more distributed BMPs, there will now be considerably more stormwater infrastructure subject to the inspection and maintenance program.

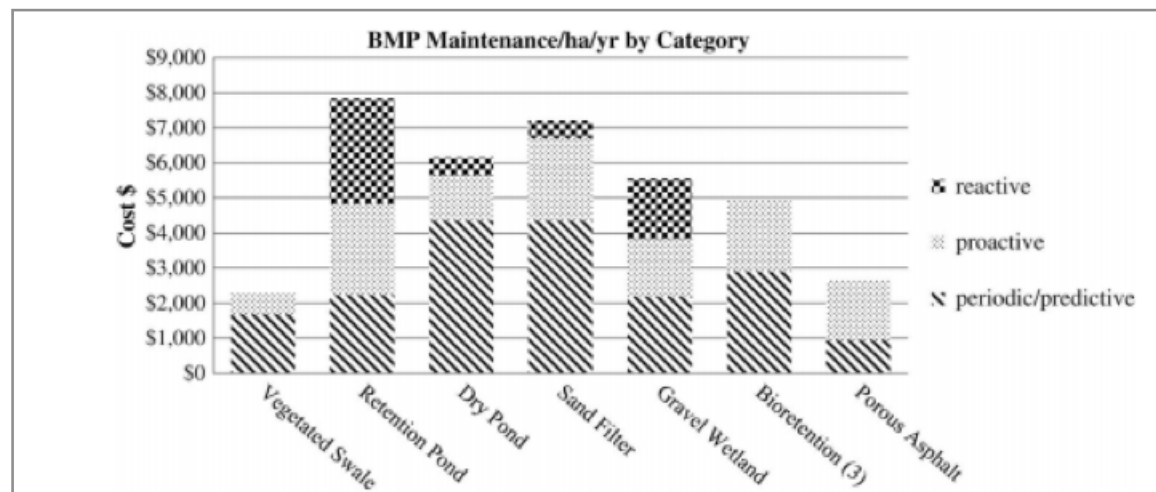

Figure 5.2-1 Annualized maintenance costs per BMP type per hectare of impervious cover (Houle et al, 2013).  
 Note: 1 hectare = 2.47 acres



### 5.2.3.1 STORMWATER SYSTEM LEVEL OF SERVICE

The extent of local program responsibility for the condition and performance of the stormwater system is generally referred to as Level of Service (LOS). A maintenance LOS is defined by the types of services the local program will provide to different parts of the drainage system. For example, within the right-of-way and in critical areas highly susceptible to flood damages, the maintenance LOS might include periodic inspection, priority cleaning, and the highest level of emergency response. This LOS may translate to providing a similar degree of service to the upstream stormwater management retention and detention structures. In similar right-of-way areas not susceptible to flooding, the level of service for maintenance might be much lower, with a corresponding lower degree of inspection responsibilities for the upstream retention and detention structures.

The LOS concept translates readily to drainage conveyance infrastructure. This concept is more complicated when the stormwater infrastructure includes on-site dual purpose BMPs for stormwater quality and flow attenuation. Responsibility for on-site stormwater management systems is typically assigned to the property owner through use of recorded maintenance agreements or another mechanism. The conveyance of that stormwater off-site, onto the neighboring property and beyond, either in a pipe or surface conveyance, is typically part of the public drainage conveyance

infrastructure within an easement or public right-of-way. As should be expected, if a local program adopts a low LOS with minimal responsibilities it should anticipate increasing complaints and possibly a growing backlog of unmet maintenance needs associated with these upstream practices.

The development of MS4 permits, TMDL requirements, and other water quality focused regulatory permit programs has created a basis for local programs to consider a water quality LOS. The extent to which a local program will conduct periodic inspections to ensure that BMPs are properly maintained by the owners of the on-site stormwater BMPs is now a programmatic requirement that is initiated at the outset of the land development process. The extent to which the local program decides to maintain neglected BMPs documented in an inspection becomes a policy decision related to the selected LOS. The decision is driven by (1) public safety and welfare and, in some cases, (2) regulatory permit compliance. In other words, the locality may be in violation of their program responsibility to ensure that water quality standards are met when these facilities are not maintained and decide to raise their selected LOS to more aggressively ensure maintenance is being performed ([see Section 5.2.4: Maintenance Program Responsibilities](#)).

### 5.2.3.2 INSPECTIONS

Inspections can be categorized as regular or routine inspections, and periodic (oversight) inspections.

### Routine Inspections

Routine inspections are usually performed by the BMP owner and conducted on a regular schedule based on the specific BMP type and level of activity or traffic in the contributing drainage area (high traffic sites may require more frequent inspections). The following are some general guidelines for routine inspections:

- The proposed schedule of routine inspections can be modified as experience identifies site-specific conditions and pollutant loading.
- Routine inspections can also include 'drive-by' inspections after measureable rainfall events. A programmatic decision may identify target rainfall depths as BMP-specific triggers for inspections (i.e., large storms for flow attenuation structures).
- Credentials of inspectors conducting routine inspections may vary by BMP type.
  - » Large impoundment structures with embankments, hydraulic control structures, principal and emergency spillways, etc. should be conducted by a qualified licensed engineer (or another comparably qualified individual).
  - » Underground vaults, filters, etc., should be inspected by a qualified licensed engineer (or another comparably qualified individual). These systems may require special equipment or confined space certification.

» *Homeowner BMPs* (located on individual residential lots) are generally simple with the primary pollutant removal pathways consisting of filtering through vegetation, soil media infiltration/extended filtration, and/or shallow surface volume, with few structural components. These systems can be periodically inspected and documented by property owners.

#### Periodic (Oversight) Inspections

Periodic (oversight) inspections are conducted by the designated local program personnel or a hired contractor and are intended to verify that the routine maintenance is being performed as stated in the Maintenance Agreement and, where applicable, to verify that routine inspections are being conducted and recorded. These periodic inspections are generally conducted on a schedule as part of the local stormwater program and stormwater permit compliance review, and should include inspection forms and photographs.

#### 5.2.3.3 MAINTENANCE

Maintenance activities can be divided into two types: scheduled (routine) maintenance and corrective maintenance.

#### Scheduled (Routine) Maintenance

Scheduled (routine) maintenance tasks are those that are typically accomplished on a regular basis by the owner or owner's representative and can generally be scheduled without referencing inspection reports or requiring special equipment (depending on the stormwater practice). The

minimal maintenance items should be listed in the design specifications and recorded maintenance agreement, and will usually include frequently scheduled maintenance items, such as trash removal, or grass mowing in the summer months, as well as less frequent items, such as removal of woody vegetation from embankments and removal of sediment from forebays.

#### Corrective Maintenance

Routine inspections or the process of performing routine maintenance will periodically reveal the need for more extensive maintenance efforts, such as removal of more sediment than is typically done with hand tools or a significant corrective action (i.e. structural repair of an inflow pipe end section or riser structure). This is generally how the inspection and routine maintenance process should work; however, this also makes it difficult to plan or budget for these activities. Reviewing the routine inspection and maintenance documentation along with accompanying photographs should provide a general sense of the likely corrective maintenance needs.

Also, similar to the scheduled maintenance, there are regular long-term maintenance needs associated with some BMPs that have a predicted schedule, albeit with a very broad range (i.e. wet pond major sediment dredging/removal schedule of 10 to 20 years). This range is very dependent on conditions in the contributing drainage area; instances of ongoing construction activity or large

pervious areas may shorten this range significantly. Likewise, high density commercial or residential areas may generate very little sediment, with the likely alternative of requiring more frequent trash removal.

#### 5.2.4 Maintenance Program Responsibility

There are many possible approaches to assigning responsibilities for stormwater maintenance. Three basic approaches are presented here:

- Limited Local Responsibility;
- Expanded Local Responsibility; and
- Comprehensive Local Responsibility.

It should be noted that aside from Homeowner BMPs the local program authority should utilize right-of-entry easements and the recorded maintenance agreements to reserve the right to enter a property to perform corrective or routine maintenance after proper notification of the owner, where it is determined that public safety and welfare may be at risk. The formula for evaluating the LOS for a maintenance program will be different for each locality; however, the decision to quickly perform maintenance will often result in beneficial public relations. Examples include instances of embankments in disrepair that could result in adjacent property damage and 'dry' BMPs that are holding water, causing vector-borne disease concerns. The local program can file a lien or utilize other mechanisms to recover costs.

Having this ultimate responsibility for the safety and welfare of the public may be a challenge for local program decision-makers considering the application and maintenance of various BMPs. For example:

A residential subdivision with a homeowner's association owns a stormwater pond located out of sight and out of mind of the residents, who have little understanding of the purpose of the pond and how it operates and even less funding available to repair and maintain it. Based on the potential impact to the public, should the local program:

1. **Pursue enforcement and require the homeowner's association to perform required maintenance?** This action will likely result in years of inactivity since there is no simple means to compel a homeowner's association to take action. Meanwhile the safety issue remains in place.

OR

2. **Perform the maintenance overhaul and then file a lien against the individual properties to recover costs?** Filing a lien will require liens on each residence and will only be collected upon the sale of the individual property (there may be other legal avenues to collect the money, however, there are no simple processes when it comes to recovering expenses). The local program has expended the funds to perform maintenance, and will possibly spend much more in legal costs trying to collect.

OR

3. **Take over future maintenance responsibilities of the basin and perform the complete overhaul?** This is the same as option 2 without the recovery of costs, and with the addition of future maintenance. Localities that have pursued this third option generally do so in recognition of the savings associated with repairing or bringing a BMP up to current standards, and conducting 'preventive' scheduled inspections and routine maintenance in the future.

This is clearly a difficult question to answer, with no perfect solution. The best approach is to avoid the situation in the first place where possible, by clearly defining maintenance responsibilities (see Section 5.2.4.1), making a concerted effort to communicate maintenance responsibilities to the public (see Section 5.2.4.2), and encouraging BMP designs that reduce the maintenance burden overall (see Section 5.2.6).

#### 5.2.4.1 ASSIGNING INSPECTION AND MAINTENANCE RESPONSIBILITY

The following provides a brief explanation of three basic approaches for assigning local program responsibility (numerous other combinations or hybrid approaches are possible):

##### Limited Local Responsibility

Limited local responsibility is exactly what it sounds like: the local program is only responsible for the BMPs and stormwater system infrastructure that they own; that is, systems within the

public right-of-way or on publicly owned land (schools, local parks, etc.). Adopting this approach means the local program would have no involvement with any stormwater systems on private property, except for possible regulatory enforcement action or in response to a threat to public safety, as noted above. However, in order to minimize the occurrence of enforcement actions, the local program will have to exert the initial effort to educate homeowners on the presence and purpose of their BMPs, and engage them in a discussion of possible homeowner association funding mechanisms to address current and/or future maintenance.

##### Expanded Local Responsibility

Expanded local responsibility means that in addition to maintaining and operating publicly owned stormwater systems, the local program has determined that it should maintain and operate some of the private portions of the system. This approach could be chosen in an attempt to prevent the problems of neglected BMPs that will likely become the local program's responsibility anyway.

The challenge with this approach is the establishment of a very objective process for taking over private BMPs. Taking over the greatest health and safety risks in some ways creates an incentive for owners to neglect their BMP, due to the expectation that the local program will take over. One option considered by several jurisdictions is local program acceptance of the routine inspection and periodic corrective maintenance responsibilities on all single-family residential development BMPs (no commercial or industrial BMPs, LID or otherwise), while designating all the routine maintenance (grass cutting or other routine activities as designated by the maintenance plan) to the owner. This includes only structural 'centralized' BMPs on out parcels or within easements (no Homeowner BMPs). This approach is in response to the challenges that typical HOAs face in generating sufficient funding to contract qualified resources for inspections or corrective maintenance. It is anticipated that the application of local program expertise in conducting periodic inspections will help keep the long-term costs of periodic corrective maintenance to a minimum by addressing issues before they require costly structural repairs.

#### Comprehensive Local Responsibility

A comprehensive local responsibility approach would fold the inspection and maintenance responsibilities for all stormwater systems within its jurisdictional boundaries into the local program. This approach has been gaining some supporters in watersheds with TMDLs, potentially providing the local program with a long list of potential

retrofit opportunities. The primary obstacle to this approach is funding. However, the implementation of a stormwater utility becomes an easier sell to the community because there is no question as to the utility services that will be provided.

It is important to note that the Comprehensive and Expanded Local Responsibility options should exclude the Homeowner BMP category, and should only include those BMPs that manage runoff from multiple lots or the public right-of-way, which are located on out parcels and/or within easements. Also, to the extent practicable, routine maintenance responsibilities, such as grass cutting and periodic debris removal, should remain with the owners.

#### 5.2.4.2 COMMUNICATING PROGRAM RESPONSIBILITIES TO THE PUBLIC

Once decisions have been made as to the assignment of maintenance responsibilities, the local program should utilize available resources to communicate these decisions to the public. In the modern world of communication there should never be a case where the owners of a stormwater BMP are unaware of their ownership and assigned responsibility. The documentation associated with purchasing a home, including the required HOA agreements and restrictive covenants for new developments, combined with the ongoing expansion of social media and other forms of public education and outreach offer numerous opportunities to reach and educate the public.

There have been several case studies on effective messaging and formatting of public education and outreach in response to MS4 permit programs. The goal of the local program should be to ensure that the community understands the roles, responsibilities, and long-term benefits of the selected maintenance program. The following are some basic considerations in communicating various responsibilities to the public:

- Communicate policy decisions along with the program goals and community characteristics upon which they are based in explicit language;
- Cover all aspects of the program; don't assume that all parties will recognize implied responsibilities;
- Utilize easement agreements, maintenance agreements, and similar documentation to clearly outline rights and responsibilities where applicable; don't assume that public outreach can replace the need for enforceable agreements;
- Develop a maintenance guidebook and other technical documentation to allow the development and design community to provide consistent messaging; and
- Incorporate appropriate messaging and communication skills into staff training to help them more effectively communicate responsibilities to the public during routine and periodic inspections.

### 5.2.4.3 INSPECTION AND MAINTENANCE STAFF RESOURCES

Local programs should evaluate the scale of the stormwater system, level of service, and designated local program responsibility (limited vs. comprehensive) to estimate the resources needed to fulfill the basic responsibilities:

- Periodic inspection of post construction BMPs (based on the required or desired inspection frequency);
- Routine inspections of publicly owned stormwater facilities;
- Routine maintenance of publicly owned stormwater facilities; and
- Periodic corrective maintenance of publicly owned facilities.

Evaluating the capacity of in-house staff to conduct BMP inspections and maintenance, or decisions on expanding the role of other department personnel responsible for operating and managing utilities, buildings, and roads, along with the option of using private contractors, represents a complex process beyond the scope of this manual. However, there will be cases where the amount of development, scale of the jurisdiction and local staff, or other limiting factors will make the decision relatively straightforward (with the option of changing that decision as circumstances or experience in implementing the program change). The use of qualified private contractors may be more efficient than hiring new staff and

purchasing equipment while trying to establish a stormwater program. Similarly, localities may elect to enter into an agreement with the water and sewer utility, a neighboring jurisdiction, or transportation agency to share maintenance responsibilities and maximize economies of scale in the use of equipment and personnel.

### 5.2.5 Legal Authority

Adoption of an MS4 permit has increased the role of the stormwater management program into functions that may be spread across many local government divisions, programs, and local ordinances. Requirements for the inspection and maintenance program should be identified with clear legal authority. The following offers some suggestions for utilizing local ordinances and legal agreements to minimize legal and other challenges to the local program.

#### 5.2.5.1 LOCAL ORDINANCE PROVISIONS

All requirements for the inspection and maintenance program should be included in a local ordinance or, where applicable, in a separate formal policy document. Having these provisions formally documented will simplify the process of communicating with the development community and the public in general. Further, the process of incorporating these provisions into an ordinance ensures that the governing political body is fully aware of the requirements and can help support the program staff when questions or complaints are elevated to that level.

The following represent items that should be adopted by ordinance:

- **Purpose and Intent:** The local ordinance will likely include language that, among other things, it is intended to 'protect, maintain, and enhance the public health, safety, and general welfare'. This section should include a clear statement regarding the establishment and ongoing implementation of long-term inspection and maintenance program roles and responsibilities.
- **Applicability:** Establish a hierarchy if any language in the ordinance is deemed to be in conflict with other local provisions. This is especially useful when complex zoning, subdivision, and other development standards are in place and conflicts may not be apparent during the development of the stormwater inspection and maintenance program.
- **Stormwater Program Department Responsibilities:** As noted above, the role of the local stormwater program has grown. The specific roles and responsibilities of the local inspection and maintenance program should be itemized in very clear terms with further narrative or criteria included in the appropriate sections.
- **Definitions:** Include the various stormwater system component definitions that may be referenced in the inspection and maintenance program section or policy document.

- **Variations:** It is hard to determine all of the potential situations or site conditions that may arise related to land development. Requests for variances to stormwater technical criteria are very common. Once the inspection and maintenance program has been defined and there is even the slightest possibility of conditions that may justify a variance of any kind to that program (which is impossible to rule out), this section should include a process by which requests should be made, who is responsible for reviewing and decision-making, and, if possible, the parameters that will be used in making those decisions.
- **Technical Criteria and Design Standards:** Include any additional design standards that may be applicable to facilitating long-term inspection and maintenance. As it is more likely that the ordinance will only reference the technical criteria (design storms, calculations, etc.), rather than the full design standards for the BMPs, be sure that the desired maintenance provisions are considered a requirement and not simply a 'good idea'.
- **Plan Submittal Requirements, Review, and Approval Procedures:** Include requirements for access easements, maintenance agreements and plans, etc., tailored for specific BMPs. These provisions should be reviewed during the plan review process for accuracy, and recorded prior to either plan approval or other milestones in the project construction prior to permit termination and/or project occupancy.

- **Inspections:** What is the role of the inspector and what does the inspector's authority include? An inspection section should address erosion and sediment control, BMP construction, and post-construction inspections separately, delineating the authority of the inspector in terms of right of access for purposes of inspection, sampling of stormwater, etc.
- **Enforcement:** Identify levels of enforcement for the violation of an inspection and maintenance agreement, including the administrative steps for communicating the initiation and prosecution of enforcement actions, such as notice of violation, establishment of a time frame and designation of remedial actions necessary, and the level of penalties, including civil and criminal penalties. Additional language should address the local program's rights to address immediate danger to the public health, safety, or general welfare because of unsafe conditions or improper maintenance, including explicit language for the recovery of costs.
- **As-built Plans (Record Drawings):** Establish minimum requirements of as-built drawings compiled by a licensed professional engineer to document that the BMP was built in accordance with the approved plans. This represents a difficult task for a Professional Engineer that was not present during the construction of the BMP. Inspection checklists applicable to the specific BMP being built should include 'milestone' inspections when the licensed Professional Engineer should

document compliance with subsurface construction elements, such as underdrains, compaction (or scarifying) of sub soils, riser barrel connections, etc. This individual will then be able to complete the as-built survey of required surface features and certify compliance with the plans.

- **Inspection and Maintenance Responsibilities:** Explicit inspection and maintenance roles and responsibilities of the owner and local program personnel should be itemized, along with any provisions related to development type (commercial, industrial, residential, etc.). This includes any specific qualifications of inspectors, documentation format (checklist) requirements, record keeping, and reporting. This section should reference the enforcement section and any other applicable 'failure to maintain' provisions.



### 5.2.5.2 INSPECTION AND MAINTENANCE AGREEMENTS

Whenever stormwater BMPs are identified on a stormwater plan and utilized for compliance with ordinance requirements, regardless of being structural or non-structural, the inspection and maintenance requirements must be explicitly stated, implemented, and when necessary, enforced. For example, a permit or maintenance agreement could specify that the local government accepts responsibility for inspecting and maintaining the stormwater system's structural components, including the periodic removal of debris and accumulated sediments. However, vegetative and aesthetic maintenance would still be performed (or contracted) by the owner. Some key aspects of these permits or maintenance agreements is the clear delineation of responsibilities, such as:

- As-Built documents, including designed property access to the BMP for inspections and maintenance;
- Identification of who will perform routine inspection duties and how often;
- Listed routine maintenance duties that are to be performed by the owner, such as mowing, debris removal, and replanting of vegetation;
- Defined roles for the local government, possibly including routine inspections and/or corrective maintenance or modifications to the system;

- Identification of enforcement provisions in the local ordinance and a statement of recourse for failure to perform the agreed upon responsibilities; and
- Requirements for documentation and/or reporting frequency (i.e., annually), along with an attached inspection form (a standardized format will help in utilizing a database system for tracking records).

An inspection and maintenance agreement should be developed specifically for each BMP. This is important for educating the property owner, but also for eliminating the question of enforceability when inspections and/or routine maintenance are not being performed. Consider some of the typical routine inspection elements for a stormwater detention basin, which should be performed by a qualified individual (i.e., licensed Professional Engineer with appropriate certifications):

- Inspection of the embankment for stability and seepage
- Inspection of the riser for structural integrity
- Inspection of the riser-barrel (principal spillway) connection for water tightness
- Inspection of the emergency spillway for signs of scour
- Inspection of the basin volume for excessive volume loss due to sedimentation

In contrast, consider the inspection of an LID or Homeowner BMP:

- Inspection of raingarden (drains properly within 24 hours of rainfall)
- Inspection of raingarden storage volume (standard dimensions)
- Inspection of positive drainage from raingarden away from the house foundation
- Inspection of plants (health, control of invasive species, removal of weeds)

An example Maintenance Agreement is provided in [Appendix D](#).

### 5.2.6 Inspection and Maintenance by Design

Maintenance must be considered throughout each component of the entire stormwater program. The long-term inspection and maintenance components can represent the largest investment of program resources, thereby making it critical to look for opportunities to incorporate policies and procedures that lead to a cost-effective program. As noted previously, this includes inserting maintenance related design and construction elements into the local ordinance, BMP design standards, and policies, and ensuring that these provisions are upheld during construction.

The following are tips on how to tailor design and construction procedures to minimize long-term maintenance needs. It should be noted that most of this guidance refers to centralized or subdivision scale BMPs, and that Homeowner BMPs should be considered separately.

- **BMP Selection:** The selection of BMPs is often driven by the performance credit or compliance value; that is: what is required in order to achieve compliance with the local program performance goals. This may include treatment trains of multiple BMPs where the order of BMPs in the treatment train can influence the overall compliance and construction costs. Unfortunately, the designer and/or developer of the project may not be responsible for long-term maintenance and is therefore considering the construction costs over the long-term costs. One example is the use of an underground treatment system such as a sand filter or proprietary device. This may be appropriate in a commercial setting where space is limited and the owner can establish a maintenance contract with a qualified contractor; however, these systems represent a significant maintenance burden in a residential setting where any one of several surface BMPs would be more cost-effective for the eventual owner(s) of the practice(s).

Guidance on long-term maintenance often categorizes BMPs by a relative maintenance burden of High, Medium, or Low. This is helpful as a quick reference, but the local program should establish additional guidance and conditions for

BMP approval based on the type of development and BMPs that require simpler and/or less costly maintenance. Emphasizing nonstructural BMPs, such as conservation of natural areas, restoration of riparian areas, and disconnection of impervious surfaces, can help reduce the maintenance burden for residential property owners (whether these are Homeowner BMPs or community scale BMPs). Further, designing both structural and non-structural BMPs as components of greenways, walking trails, recreation areas, parks, streetscapes, and courtyards gives them more visibility and, therefore, a higher likelihood of receiving maintenance.

- **BMP Specific Maintenance Plans and Maintenance Agreements:** Maintenance plans and maintenance agreements should be included with the construction drawings and reviewed prior to plan approval to ensure that they reflect the specific BMPs, their locations, and anticipated ownership of the BMPs. The maintenance plan should identify responsible parties, and both the plan and the maintenance agreement should include a list and schedule for routine and periodic structural maintenance. Also, the maintenance plan and agreement should outline the legal mechanisms in place that guide or govern long-term maintenance responsibilities (i.e., access easements, subdivision restrictive covenants, and/or deed restrictions). Maintenance Checklists can assist with typical maintenance tasks for specific types of BMPs.

- **Runoff Pretreatment:** The local program BMP design specifications, plan review, and construction inspection should require and emphasize the need for runoff pretreatment upstream of all inflow points into the BMP. Proper pretreatment preserves the primary BMP pollutant removal pathway over time by sequestering larger sediment particles, trash, and organic debris. Pretreatment practices include forebays, vegetated filter strips, stone filter strips (for higher velocities), and grass channels. These practices should be located such that they are easy to access for routine inspections and maintenance.

Multiple pretreatment practices may be appropriate for high traffic development sites utilizing infiltration or filtration BMPs. Refer to the individual BMP design specifications in [Volume 2, Chapter 4](#) for the appropriate types and sizing rules of pretreatment practices.

- **Permanent Maintenance Access:** Providing permanent maintenance access includes both the access easement and the means by which maintenance equipment can access the BMP. Providing an easement over slopes too steep to navigate, or to a limited area of the BMP, will discourage if not prevent proper maintenance.

Ponds and wetlands should have access routes, with adequate width (12-foot minimum is common) and appropriate slopes (no steeper than 15% is recommended) to allow maintenance vehicles to enter and turn around, and be extended as needed to allow access to inflow locations (refer to pretreatment), outlet structures, and any other structures, such as diversion manholes or bypass structures. These roads can be constructed of reinforced turf or other pervious material so as to avoid further stormwater impacts.

- **Innovative Control Structures:** The design specifications for all BMPs should include appropriate guidance on how to achieve the intended runoff treatment for the scale of the BMP. The design of dewatering structures has evolved from establishing a minimum size of the control orifices to discourage clogging to more creative approaches. For example, the developed landscape includes numerous examples of stormwater extended detention basins and wet ponds that include a minimum 3-inch diameter orifice, since that was considered necessary to pass the expected trash and debris to avoid clogging (often referred to as the 'Budweiser' rule), even if it meant the rate of discharge exceeded the minimum allowed rate. So while maintenance was definitely being considered in the design, the goal of avoiding a maintenance burden trumped the desired water quality benefits.

The alternative has been to develop innovative strategies that create sufficient capacity to avoid clogging while also restricting discharge. A

common example is the perforated pipe buried in gravel, set at the design outlet invert elevation, with a control orifice or weir in the control structure. The perforations combine to create a large flow area that will continue to allow discharge even as sediment begins to reduce the porosity of the gravel. This allows for a much longer maintenance cycle than simply placing a small orifice at the outlet invert of the control structure. The tradeoff is that the gravel diaphragm must be periodically maintained, requiring appropriate resources and equipment. Another example is the micro-pool outlet with an inverted (reverse slope) outlet pipe. The lower elevation of the pipe is set above the micro-pool bottom to allow for the accumulation of sediment that will likely migrate towards the outlet.

Design specifications for each BMP should provide appropriate examples of outlet structure configurations. Designers are encouraged to be creative in solving this inherent design challenge: restrict the design discharge so as to promote water quality without clogging the outlet and creating unsafe (overtopping) conditions during storm events, or nuisance conditions (standing water) after storm events, while also preserving the desired maintenance cycle.

- **Maintenance By-Pass:** If, based on the scale of the BMP, it is expected that a maintenance activity will take several days or longer, the design should include provisions for routing a targeted design peak discharge around the BMP. This can include a pump well or other structure near the

inflow points. This is a very site- and BMP-specific feature, which should be considered for large detention basins and ponds.

- **Stable Conveyance Systems:** After the contributing drainage area to a BMP has been adequately stabilized (usually after one or two growing cycles), the sediment loading to the BMP should be relatively low. Since sediment is the primary cause of clogging and maintenance, this should mean that the heavy maintenance burden gradually decreases over time, leaving the more readily performed (and lower cost) vegetation management as the primary activity. Unfortunately, in cases where there is a network of open channel conveyances serving the contributing drainage area, this load can increase dramatically if the conveyances begin to erode.

Open channels, especially grass channels, can be an effective part of a treatment train, even if only for pre-treatment. Therefore, in addition to including inspection of the contributing drainage area and conveyance systems for bare spots and/or erosion, the design specifications for the conveyances should include provisions for minimizing flow velocities. Where applicable, this can also include check dams and/or forebays for sequestering sediment in an easy to access location (similar to the inflow forebay).

- **Sediment Markers and Benchmarks:** Benchmarks or graded markers can be established for tracking and monitoring BMPs. For example, graded markers can be placed in forebays, or permanent pools of ponds and wetlands, to consistently measure the depth of sediment during inspections. Sediment clean-out markers should always be used in underground vaults and in the sediment chambers of sand filters.

- **Plan for Sediment Disposal:** Removing sediment and debris is a common maintenance item for many types of BMPs. Minor debris removal is relatively simple, but removing large quantities of sediment can be an involved and costly undertaking. Design features should enhance access, as described above, and include features that simplify removal efforts. For example, a pond drain is an important design feature that allows maintenance crews to drain ponds or wetlands before removing accumulated sediment.

Sediment removal costs can be site-specific and dependent on disposal plans since it can be expensive to dispose of saturated sediment. This is not due to issues of toxicity, but rather the challenge of how and where to dispose of the material. The 'how' requires water-tight dump trucks to prevent the discharge of liquid in transit. The 'where' is related to the reluctance of landfills to accept wet material that can add to leachate concerns and the reluctance of waste water treatment plants to accept solid materials that burdens the treatment process.

A possible solution is to establish a dewatering area in the vicinity of the BMP. This includes appropriate grades so the sediment doesn't migrate back into the BMP, as well as stabilization guidance for re-stabilizing the area after the dried material is hauled to the landfill or other approved location. This strategy relies on having available space. Where this is not realistic, the maintenance plan should acknowledge the likely expense of dredging and sediment disposal.

## 5.3 Geographic Information Systems (GIS)

**Description:** A Geographic Information System (GIS) is a computer-based database system that allows a user to visualize, query, analyze, and interpret geographical data. GIS can be an important tool for a stormwater management program, assisting with tracking BMP locations and drainage area characteristics, organizing stormwater infrastructure data, and many other tasks.



### KEY CONSIDERATIONS

The main functions of GIS typically include:

- Data Input
- Data Conversion
- Query and Analysis
- Data Display
- Output
- Visualization

Example uses for GIS include:

- Mapping surface features such as land uses, soils, watershed boundaries, etc.
- Managing stormwater assets and information
- Automating tasks such as measuring areas of watersheds, plotting floodplain boundaries, etc.
- Evaluating water quality impacts
- Forecasting future land use or land cover conditions.



### 5.3.1 Introduction

A Geographic Information System (GIS) is a computer-based database system that allows a user to visualize, query, analyze, and interpret data to understand relationships, patterns, and trends. The system is designed to utilize spatial or geographical data as a collection of thematic layers or databases that can be linked together by geo-referencing a series of coordinates. GIS uses location as the key index variable to manipulate data and combine datasets to produce a wide variety of individual maps that effectively convey relationships between geographic elements and events related to stormwater management, such as topography, rainfall, and hydrography. GIS has proven invaluable for solving many real-world stormwater problems, from tracking complaints to master planning applications and infrastructure management. GIS is also a fundamental tool of asset management systems, and is used extensively by MS4s to schedule and track inspection and maintenance of the MS4's structural controls.

A GIS-based data inventory not only helps monitor existing stormwater management practices but also guides planning officials in analyzing vulnerable areas, retrofitting existing facilities, and identifying potential locations for implementing new stormwater best management practices (BMPs). Some sample base data that is helpful for assessing stormwater management potential is listed in Table 5-1.

**Table 5-1 Sample data layers for stormwater management assessment**

• Surface Parking Lots	• Stormwater Network, including ditches, catchbasins, ponds, stormwater lines, etc.
• Sidewalks	• Water Distribution Networks
• Road Widths	• Wetlands
• Building Footprints	• Existing Best Management Practices (BMPs)
• Impervious Surfaces	• High Water Marks
• Trees and Tree Canopy	• Riparian Buffer Status
• Curve Numbers	• Orthophoto
• Watershed Boundaries	• Contours
• Streams	• Land Uses
• Stream Banks	• Soils
• Floodplains	

**Table 5-2 Advantages of Using an integrated GIS/Database Management System (DBMS) to Track Stormwater Assets**

<b>Can track inventory and lifetime history</b> of stormwater assets, including the history of inventory, preventative maintenance, and condition assessments
<b>Visualize stormwater infrastructure assets</b>
<b>Collect service requests</b> with web-based citizen access, easily create work orders to address issues in a timely manner, and track the lifecycle and costs of each request
<b>Create schedules</b> configured against a single stormwater inlet or your entire system, and manage stormwater preventative maintenance schedules from your mobile device
<b>Store video and inspection comments</b> for stormwater infrastructure and other assets to review deterioration and determine requirements for repair and replacement
<b>Monitor real-time statistics</b> and extract work order, assets, and other stormwater system data into a spreadsheet for use in compatible third-party applications, presentations, or reports



### 5.3.2 GIS Components

A functional GIS integrates four key components:

- **Hardware:** Desktop or laptop computers and digitizing equipment are the primary hardware components of a typical local GIS system.
- **Software:** GIS software provides the functionality and tools needed to input, store, analyze, display, and output geographic information.
- **Data:** Generally the most costly part of a GIS is data development. Some geographic data and related tabular data can be collected in-house or purchased from commercial data providers. Many government agencies, including metropolitan planning organizations (MPOs), federal administrations, and city and county departments, maintain GIS datasets for their jurisdictions, which are typically available for public use. GIS software can integrate tabular data, image (raster) files, and electronic drafting (CAD) data to build information into the GIS database.
- **Users:** GIS technology is of limited value without trained operators who understand the data, system, organization, and how to apply resources to achieve the desired results.

### 5.3.3 GIS Functions

General purpose geographic information systems essentially perform six processes or tasks:

#### Data Input

Before geographic data can be used in a GIS, the data must be converted into a suitable digital format. The process of converting data from paper maps

into computer files is called digitizing. Modern GIS technology can sometimes automate this process fully for projects using scanning technology, though some jobs may require manual digitizing using a digitizing table. Today many types of geographic data already exist in GIS-compatible formats. These data can be obtained from a number of different sources including the Georgia GIS Data Clearing-house at <https://data.georgiaspatial.org/login.asp>.

#### Data Conversion

It is likely that some needed data may not be in the correct format or proper map projection to use with your system. Most GIS software has the ability to do this conversion, but in some cases this is better done by a contractor who specializes in data conversion. Be careful with third party data; it is imperative that you understand the source, quality, age, accuracy, and limitations of all datasets. This and other information about a dataset are often provided in Federal Geographic Data Committee (FGDC) metadata that accompanies the dataset.

#### Query and Analysis

Once there is a functioning GIS containing geographic information, it can be used to answer questions such as:

- Who owns the land parcel being flooded?
- What is the distance between two stream locations?
- Which homes are located in the updated floodplain?

- How will the new development impact downstream properties?
- What types of infrastructure give us the most complaints and where are they located?

GIS provides both simple point-and-click query capabilities and sophisticated spatial analysis tools to provide timely information to stormwater managers and analysts. GIS technology can also be used to analyze geographic data to look for patterns and trends and undertake “what if” scenarios. Most modern geographic information systems have many powerful analytical tools including:

- **Size Analysis** – Provides specific information about a feature (e.g., What is the area and perimeter of a parcel?)
- **Proximity Analysis** – Determines relationships between objects and areas (e.g., Who is located within 100 feet of the streambank?)
- **Overlay Analysis** – Performs integration of different data layers (e.g., What is the SCS curve number for this sub-watershed considering soils and land use?)
- **Network Analysis** – Analyzes the connectivity of linear features and establishes routes or direction of flow (e.g., Which pipes feed into this junction box?)
- **Raster Analysis** – Utilizes a raster model to address a number of hydrologic issues (e.g., What does the 3-D model of this watershed look like? Where does the water flow?)

### Data Display, Output and Visualization

Geographic information systems excel at allowing users to create rich and detailed maps, graphs and other types of output which can help local staff, elected officials, and the general public visualize and understand complex problems and large amounts of information. These maps and charts can be integrated with reports, three-dimensional views, photographic images, and multimedia presentations.

### 5.3.4 Use of GIS in Stormwater Management

#### Types of Uses

GIS can be useful to a community in a wide variety of stormwater-related applications:

- GIS can be used for the mapping of surface features, land uses, soils, rainfall amounts, watershed boundaries, slopes, land cover, etc.
- GIS integration with a database management system (DBMS) can be used to help manage a stormwater system inventory and information about facility conditions, storm sewer networks, inspection and maintenance scheduling, and problem areas.
- GIS can be used to automate certain tasks, such as measuring the areas of sub-watersheds, plotting floodplain boundaries, or assessing stormwater utility fees.
- GIS can be used to evaluate water quality impacts and answer cause and effect questions, such as the relationship between various land uses and in-stream pollution monitoring results.

- “What if” analyses can be undertaken with GIS. For example, various land use scenarios and their impacts on pollution or flooding can be tried in various combinations to determine the best management solutions or the outcome of current decisions. When tied to hydrology, hydraulics, and/or water quality models, this type of analysis becomes a powerful tool to assess the impacts of new development on downstream properties.
- GIS databases can provide public officials, consultants, and citizens with immediate answers and ready information. For example, inventory, complaints, and other information about stormwater infrastructure (including pictures) can be placed in a database tied to geographic location.
- Complex problems or changes over time, such as water quality improvements, can be easily visualized in maps and graphs generated by GIS systems.
- GIS maps can be used to inform and influence citizens and political leadership concerning a course of action or a project’s viability.

#### Implementation Issues

Communities often make enormous expenditures on data, hardware, software, and databases, but spend too little resources on planning, staff familiarization, training, graphical user interface (GUI), and applications development. The end result is an unusable system accessible by only a few who have the resources to learn the system, hire competent staff, and develop applications. It is generally better to target GIS implementation

to certain needs and quickly roll-out applications that work for these needs, even prior to the complete development of the database and overall system.

Proper implementation of GIS applications for stormwater management involves planning for stormwater-only applications and integration of these applications with other potential users within the municipality.

### 5.3.5 Other Related Technologies

GIS is closely related to several other types of information systems, and can be used with these other information tools, including:

- CAD—Computer-Assisted Design (CAD) systems evolved to create designs and plans of buildings and infrastructure. The systems are designed to do very detailed drafting and drawing, but have only limited capability to attach data fields to the electronic drawing. As a result these systems do not have the capability to perform spatial analysis. Fortunately these drawings can be input to GIS, saving significant time on digitizing. Once in GIS, attribute data can be added to the graphic features.
- DBMS—Database Management Systems (DBMSs) specialize in storage and management of all types of data, including geographic data. DBMSs are optimized to store and retrieve data and many geographic information systems rely on them for this purpose. They do not typically have the analytic and visualization tools that are common to GIS.
- SCADA—SCADA stands for Supervisory Control and Data Acquisition System. These systems combine the ability to monitor information (rainfall, stream flow, flood level, etc.) remotely through telemetry. SCADA systems can also execute commands to do such things as open gates or close valves from a distance. Examples of the use of SCADA include automating stormwater pump station operation, alarms for flood warning, and lowering of traffic control barrier arms during high water periods. SCADA systems can be combined with GIS to create comprehensive tracking systems.

## 5.4 Asset Management

**Description:** Asset management is a process employed to track stormwater infrastructure needs and efficiently allocate resources to promote strategic preventative maintenance and timely repairs. Stormwater programs can use asset management and tracking to help address a number of issues, including aging infrastructure, failure analysis, NPDES and TMDL compliance, inspection and maintenance, reporting requirements, and inadequate funding.



### KEY CONSIDERATIONS

A stormwater infrastructure tracking system is an integral part of the stormwater management program, which should:

- Provide detailed knowledge of stormwater practice locations and conditions;
- Provide prioritization of maintenance and replacement activities based on the risk and consequences of failure;
- Supply information for long-term conditions and performance of BMPs, which can help the design of future BMPs;
- Help estimate pollutant removal rates on a watershed (or MS4-wide) basis; and
- Support the Illicit Discharge Detection and Elimination (IDDE) program.



### 5.4.1 Introduction

Asset Management is a process of maintaining and managing assets once they are acquired or built to maximize value while providing an expected level of service. In general, asset management allows a local government to optimize asset life while focusing maintenance efforts on the most critical assets. This allows a program to improve decision-making by tracking infrastructure needs and efficiently allocating resources to promote strategic preventative maintenance and timely repairs.

Stormwater programs can use asset management and tracking to address a number of issues, such as aging infrastructure, failure analysis, NPDES and TMDL compliance, inspection and maintenance, reporting requirements, and inadequate funding. Stormwater assets are typically identified as system components with a physical and functional role (e.g., manholes, catch basins, pump stations, stormwater piping and conveyances, ponds, and outfalls). Asset management in this context means creating an inventory of existing infrastructure with location, establishing a baseline rating for the condition of the components, and then developing a system to track operations and maintenance and issue alerts when repairs are necessary. Asset management can also provide a basis to identify long-term funding needs as stormwater infrastructure begins to reach the end of its functional life, with replacement prioritized based on risk and consequences of failure.

### 5.4.2 Stormwater Infrastructure Tracking System

The stormwater infrastructure tracking system is a map-based database that tracks the location and condition of BMPs, outfalls, conveyance structures, and other stormwater infrastructure attributes. This tracking system should include a field inspection and survey program for stormwater infrastructure. The tracking system is integral to the stormwater program for the following reasons:

- Detailed knowledge of stormwater practice location and condition is needed to ensure ongoing maintenance.
- Long-term condition and performance of specific BMPs and BMP design elements can help to inform the future BMP design process.
- BMP condition can reflect the effectiveness of the program.
- Integration of BMP data with land use data can be used to develop models that estimate pollutant removal on a watershed- or MS4-wide basis
- As a supplemental benefit, mapping of outfalls and infrastructure will support the Illicit Discharge Detection and Elimination (IDDE) program.

Because a stormwater infrastructure inventory program can be an ambitious and costly undertaking, it can be phased over time. For instance, the program can start with newly installed BMPs

and major outfalls, followed by older BMPs, minor outfalls, and conveyance elements.

An important part of the inventory, in addition to the location and type of BMP, is an assessment of the physical and regulatory condition of the system, including the following:

- BMP type and location
- Contributing drainage area statistics
- Control structure type and design elevations
- Location of outfall and receiving stream
- BMP and conveyance stability and functionality
- The regulatory condition
  - » Located within easement
  - » Covered by maintenance agreement
  - » Maintenance access
  - » Proper maintenance being performed
- Previous inspections
  - » Inspection dates
  - » Maintenance dates
  - » Specific maintenance tasks performed
  - » Digital photographs

All data entered into the database should be verified and updated over time through field inspections. For example, the quality of the location data can be enhanced through the use of handheld global positioning system (GPS) units during ongoing operation and maintenance activities, as well as when new stormwater infrastructure elements are added.

The specific data collected during field inspections can be used to determine what percentage of practices meet particular stormwater practice performance goals, such as:

- Sediment forebays should be no more than half full of sediment.
- Vegetation should cover at least 80% of the surface area of bioretention and wetland BMPs.
- Emergency spillways should be clear of debris and obstructions.
- Open channels should be stable (not eroding) and free of sediment deposits.
- Catch basin sediment should not comprise more than 25% of the space below pipe inverts.

These data are also used as triggers for when maintenance should be performed by the municipality or other responsible party. The authority and ability to track stormwater infrastructure maintenance work can help ensure regular compliance with a maintenance plan.

In parallel with physical infrastructure mapping, the MS4 needs a readily available, accurate, and preferably digital mapping layer of any easements and property boundaries. These data help in determining which practices have adequate maintenance access, and they help in identifying situations where a new agreement with a private property owner is needed to conduct regular inspections and maintenance.

### 5.4.3 Land Use and Land Cover Tracking

The ultimate effectiveness of a program needs to be evaluated in the context of changing land use. Many of the codes and policies implemented as a part of a post-construction stormwater program, such as implementation of LID or open space design techniques, can directly affect future land use. Consequently, updating basic land use layers in GIS is critical to understanding the actual benefits of the program.

Baseline data, including a good measure of impervious cover, land use, land cover, and developed areas, should be developed early in the process. These data should then be overlaid with zoning data or another estimate of future land use. Taken together, these data can help identify sensitive watersheds, as well as areas of potential growth.

Ultimately, these data help to inform decisions about redevelopment policies, zoning, and stormwater criteria. They also help the community to

understand realistic pollutant reduction goals in the context of existing land use and future development pressures. Finally, these land use layers help the MS4 identify areas for potential stormwater retrofits.

These basic land use and land cover data can be supplemented with additional data that can help the MS4 better understand habitats and pollutant loading potentials. Some examples include stream, wetland, or forest assessments that identify high-value resources, or locations of stormwater hotspots that identify key pollutant load sources. Another example is a green space inventory, in which a community inventories landscape scale features that help manage stormwater and would aggravate stormwater problems if development is allowed there, including floodplains, stream buffers, and wetlands.

Land use and land cover data should be continuously updated to the extent possible. A plan review tracking system can be a direct source of information, as long as the existing and current land uses are accurately recorded for each development plan. As these data are updated, the MS4 can periodically reevaluate progress toward watershed-wide goals identified at the program's onset.



## 5.4.4 Reporting

Asset management in this context is about ensuring that mechanisms are in place so data generated by the system is communicated to the proper departments and agencies. These reports can be generated weekly, monthly, or yearly based on need. Weekly reports would be used for tracking inspection and maintenance demand, while monthly reports might be designed to track NPDES, TMDL, or state required goals.



### CASE STUDY

#### DeKalb County Asset Management

DeKalb County is responsible for inspection and maintenance of over 150,000 public stormwater assets, 20% of which must be inspected every year, according to their MS4 permit. These inspections include permanent control structures (catch basins, pipe conduits, ditches, ponds, etc.), dry weather outfall inspections for illicit discharges, highly visible pollutant source businesses, industrial facilities that are required to have an NPDES permit, and privately maintained detention ponds. In the past, all inspection and maintenance records were prepared on paper and manually entered into the County database. With help from a consultant, the County is switching to a geographically linked asset management system – a web-based program that incorporates ArcGIS to help with stormwater asset inspections, inventory updates, and reporting. With this program, inspectors will be able to access and document inspections in real-time, rather than returning to the office to look up data or manually enter records into a database. The result is expected to be a significant improvement in inspector efficiency and productivity.

Source: Kurz, J.S., Proceedings of the 2013 Georgia Water Resources Conference, held April 10–11, 2013, at the University of Georgia



### CASE STUDY

#### Coweta County Asset Inspection Program

Industrial and commercial growth has put significant pressure on Coweta County's infrastructure in the past 20 years. In that time, the population has more than doubled, to 130,000.

"The growth in all aspects of our community has resulted in us just trying to keep up with infrastructure," Cowetta County stormwater resources manager Brice Martin said. "The big thing is keeping up with our assets and trying not to outpace ourselves. We don't want to get to the point where we have a lot of infrastructure going in and we are not able to keep up with it." In just the past two years, something else doubled: daily infrastructure inspections. Coweta County recently became part of the Metropolitan North Georgia Water Planning District, resulting in stricter regional mandates, including inspecting all urbanized infrastructure and at least 10 percent of assets in unincorporated areas.

To keep up with the new annual inspection requirement, the County invested in better mobile device capabilities. Rather than relying on a device that required daily downloads and uploads to and from the County's GIS system, the County converted to a tablet-based system that would automatically download and upload GIS information over the internet. The improved system has led to a doubling of inspector productivity – from 50 inspections per day to over 100.

Source: Double Time in Georgia: Coweta County Public Utility District Moves Twice as Fast with ArcGIS on iPad. 2014. Esri News for Water & Wastewater.

## 5.5 Funding

Description: Adequate funding is an essential part of a stormwater management program. While General Fund monies may be the most common funding approach, many other effective strategies exist.

### ! KEY CONSIDERATIONS

Funding strategies covered in this section include:

- General Fund
- Stormwater Utilities
- Grant and Loan Programs
  - » Clean Water State Revolving Fund (CWSRF)
  - » Section 319(h) Georgia's Nonpoint Source Implementation Grant
  - » Department of Community Affairs (DCA) Water First
  - » National Flood Insurance Program (NFIP) Community Rating System (CRS)
  - » Coastal Incentive Grant (CIG) Program
- Other Funding Sources
  - » General Obligations Bonds
  - » Development Impact Fees
  - » Special Assessments/Tax Districts

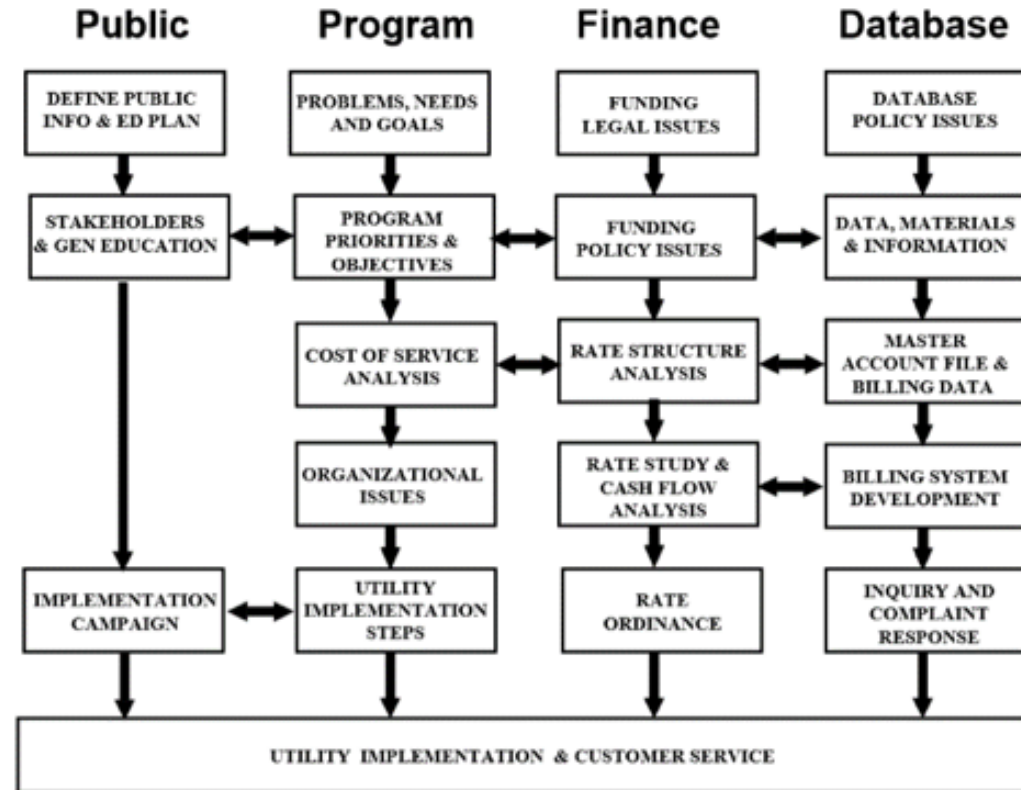

### 5.5.1 Introduction

Adequate funding of local stormwater management program activities is perhaps one of the most critical, yet difficult, aspects of establishing a comprehensive stormwater management program. The best-designed stormwater management program will flounder without sufficient community support and a stable and sufficient funding source. Funding is required for the formation and ongoing operation of a local stormwater program. With regard to long-term operation of the program, the key funding issues are: (1) how much money is required to fund the program annually and (2) how to support the program with a consistent and dedicated funding base. An effective and ongoing program that includes planning, engineering, plan review, capital improvements, maintenance, and enforcement activities will typically require more resources than what is available from general appropriations.

In Georgia, general revenues from property taxes are typically the main funding source for local stormwater management activities. However, there are a number of alternative funding methods for stormwater management programs, including the sale of bonds, development impact fees, the formation of local improvement districts, and the creation of stormwater user fee systems (also known as stormwater utilities). Each funding approach has its advantages and limitations. These methods are discussed below and should be assessed as to potential revenue, suitability, and public acceptance.

### 5.5.2 General Fund

General appropriations are a traditional way of funding most government programs and services. The strongest advantage of general funding is that it represents a stable funding source from local taxes. The disadvantage is that stormwater activities must compete with other local programs and activities for limited funds. A government that elects to use its general fund may subject its stormwater operations to budget deliberations each fiscal year.

### 5.5.3 Stormwater Utilities

A stormwater user fee system is a financing option that provides a stable and dedicated revenue source for stormwater management. User fees for stormwater management present an alternative to increased taxes or impact fees for the support of local program operations and maintenance, as well as funding of other stormwater program activities. In a stormwater user fee system, stormwater infrastructure and programs are considered a public service or utility, similar to wastewater and water programs that are funded on a similar basis. As with water and wastewater rates, stormwater fees are assessed on users of the system based on average conditions for groups of customers with similar service requirements. Typically, fees are based on some measure of a property's impervious area. Rates may be assessed in charges per either equivalent dwelling unit (EDU) (e.g., "x" dollars per EDU per month) or unit area (e.g., "x" dollars per 100 square feet per month). Alternative methodologies include the use of a runoff factor

or coefficient based on the type or category of land use, a flat fee per customer, or a combination of any of these methods.

A stormwater utility operates similarly to water, sewer, or fire districts, which are funded through service fees and administered separately from the general tax fund, ensuring stable and adequate funding for these public services. Stormwater utilities have existed for a number of years in several states, but have only recently been used in Georgia.

A stormwater utility can provide a vehicle for:

- Consolidating or coordinating activities and responsibilities that were previously dispersed among several departments and divisions;
- Generating funding that is adequate, stable, and equitable (as it is borne by the user on the basis of the user's demand placed on the stormwater system), and dedicated solely to stormwater management; and
- Developing programs that are comprehensive, cohesive, and consistent year-to-year.

Generally a community enacts two ordinances to create a stormwater utility, one to establish the various components of the utility and the other to determine the rate structure. Forming the utility through two separate ordinances allows the flexibility to alter the rate structure without having to revise the ordinance governing the basic structure of the utility. The first ordinance may also include a statement of the goals of the utility. The second ordinance tries to structure the service charges to create a logical and equitable relationship between the quantity of stormwater leaving a property, the benefits received from the stormwater system, and the amount assessed.

The stormwater utility rate should be designed to defray the costs of the service provided by the municipality. It is important that there is an equitable relationship between the amount of stormwater generated by a given property, the benefit received by the ratepayer, and the corresponding fee assessed. Generally, case law suggests that a rate will be deemed valid where: (1) the revenue generated benefits for the payers primarily, if not exclusively; (2) revenue is only used for the projects for which it was generated; (3) the revenue generated does not exceed the costs of the projects; and (4) the rate is uniformly applied among similarly situated properties.

Below are several features that should enhance a stormwater utility's chances of surviving any legal challenge:

- Operation as a separate public utility (similar to a water or power utility)
- Detailed findings explaining why the project is needed to protect public health, safety, and welfare
- Revenues from fees are segregated and managed as a separate fund
- Fees are proportionate to the burden placed on the system by class of property
- Credits can be implemented
- Findings and resultant fees are based on a professional analysis
- An appeal process is provided

Though they are not without significant administrative, political, and potential legal hurdles, stormwater utilities are worth considering as a potential funding source for local stormwater management activities.

The Georgia Stormwater Utility Dashboard is a useful tool to explore and compare stormwater utility fees for the many Georgia communities that have already adopted one. <http://www.efc.sog.unc.edu/reslib/item/ga-stormwater-utility-dashboard>

For more information on stormwater utilities and other stormwater funding mechanisms, see the National Association of Flood and Stormwater Management Agencies' Guidance for Municipal

Stormwater Funding: [http://www.epa.gov/sites/production/files/2015-09/documents/guidance-manual-version-2x-2\\_0.pdf](http://www.epa.gov/sites/production/files/2015-09/documents/guidance-manual-version-2x-2_0.pdf)



## CASE STUDY

### Stormwater Utilities in Georgia

In 2012, the Environmental Finance Center at the University of North Carolina, Chapel Hill performed a survey of existing stormwater utilities in the State of Georgia. At the time, there were a total of 44 stormwater utilities in existence. Key facts and observations from the survey included:

- Populations served by utilities range from 2,900 people in Avondale Estates to over 800,000 in Gwinnett County.
- Monthly fees for residential customers range from \$0.10 to \$6.00, with a median rate of \$4.00.
- 34 of the 44 utilities offer a credit for installation of stormwater BMPs.

More information can be found in the report Approaches to Stormwater Management: Stormwater Utilities and Green Infrastructure [http://www.efc.sog.unc.edu/sites/www.efc.sog.unc.edu/files/White%20Paper\\_Stormwater%20Overview%20for%20Rincon\\_GA\\_v6.pdf](http://www.efc.sog.unc.edu/sites/www.efc.sog.unc.edu/files/White%20Paper_Stormwater%20Overview%20for%20Rincon_GA_v6.pdf)

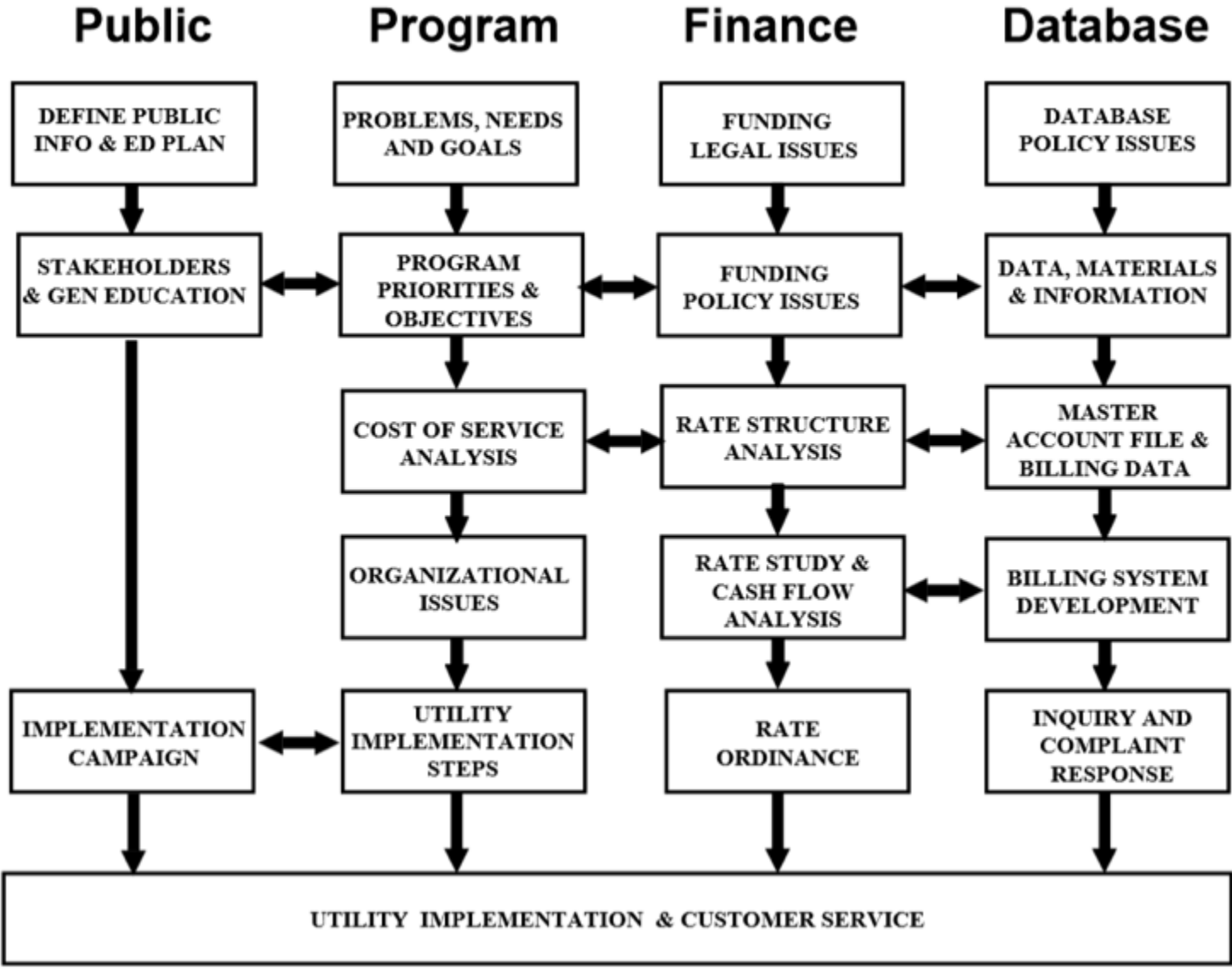

Figure 5.5-1 Utility Implementation Approach from *Guidance for Municipal Stormwater Funding*.

### 5.5.4 Grant and Loan Programs

The following loan and grant programs provide credits and incentives to communities that incorporate green infrastructure/LID practices into their projects and regulations. Some of these programs apply only to government entities, while others apply to actual projects. The websites given for each program can be referenced for more information.

#### The Clean Water State Revolving Fund (CWSRF)

The Clean Water State Revolving Fund (CWSRF) is a federal loan program administered by the Georgia Environmental Finance Authority (GEFA) that provides funding for pollution prevention projects. Green infrastructure projects consisting of site- and neighborhood-specific practices, such as bioretention, trees, green roofs, permeable pavements, and cisterns are eligible for funding. Reference the GEFA website for more information: <http://gefa.georgia.gov/clean-water-state-revolving-fund>



#### Section 319(h) Georgia's Nonpoint Source Implementation Grant

Under Section 319(h) of the Clean Water Act, the U.S. Environmental Protection Agency (USEPA) awards a Nonpoint Source Implementation Grant to the Georgia Environmental Protection Division (GAEPD) to fund projects in support of Georgia's Nonpoint Source Management Program. Funding is distributed via a competitive process to projects that will lead to direct reductions in pollutant loads and measurable water quality improvements.

Eligible applicants include: public agencies, such as local, regional, or state governments; authorities that operate service or delivery programs (e.g., sewer, water); regional commissions; agricultural conservation councils; and school and university systems. State law prohibits non-governmental organizations from receiving Section 319(h) funds directly; but, these organizations are encouraged to form partnerships with public agencies to develop or implement projects. Stormwater projects are reviewed to determine whether or not they are specifically required in MS4 permits. This funding cannot be used to implement MS4 permits. More information regarding the grant can be found at: <http://epd.georgia.gov/section-319h-georgias-nonpoint-source-implementation-grant>



#### Department of Community Affairs (DCA) WaterFirst

The WaterFirst Community Program is a voluntary partnership between local governments, state agencies, and other organizations working together to increase the quality of life in communities through wise management and protection of valuable water resources. This proactive approach to water resources requires local governments to make the connection between land use and water quality, and think beyond political boundaries to recognize the inextricable links created by shared water resources. The intended result of the program is the achievement of excellence beyond the current water regulations in seven major categories:

- Watershed Assessment

- Stormwater Master Planning
- Wastewater Treatment and Management
- Water Supply Planning
- Water Supply Protection
- Water Conservation
- Water Reclamation and Reuse



Participation benefits include resources, tools, and support to help meet water management goals and state-wide recognition for being environmental stewards. In addition to the Participation Benefits, designated communities receive:

- A 1% interest rate reduction for Georgia Environmental Finance Authority water-related loans;
- Annual eligibility for DCA Community Block Development Grants for water related projects;
- Priority for EPD 319 Grant funding; and
- State-wide recognition, including road signage and authorization to use the WaterFirst trademarked logo.

More information on the WaterFirst program can be found at: <http://www.dca.state.ga.us/development/PlanningQualityGrowth/programs/Water-ResourcesTechnicalAssistance.asp>



## National Flood Insurance Program (NFIP) Community Rating System (CRS)



The National Flood Insurance Program's (NFIP) Community Rating System (CRS) was implemented in 1990 as a voluntary program for recognizing and encouraging community floodplain management activities exceeding the NFIP's minimum standards. Any community that is in full compliance with the NFIP's minimum floodplain management requirements may apply to join CRS.

As a result of joining the CRS, flood insurance premium rates are discounted to reflect the reduced flood risk resulting from community actions meeting the three goals of the CRS:

1. Reduce flood damage to insurable property;
2. Strengthen and support the insurance aspects of the NFIP; and
3. Encourage a comprehensive approach to floodplain management.

The CRS uses a method that is similar to fire insurance rating to determine flood insurance premium reductions for residents. Most communities enter the program at a CRS Class 9 or 8 rating, which entitles residents in Special Flood Hazard Areas (SFHAs) to a 5% discount on their flood insurance premiums for a Class 9, or 10% discount for Class 8. Each CRS Class improvement produces a 5% greater discount on flood insurance premiums for properties in the SFHA. More information about the CRS program can be found

at: <https://www.fema.gov/national-flood-insurance-program-community-rating-system>

## Coastal Incentive Grant (CIG) Program

The Coastal Incentive Grant (CIG) Program is a competitive pass-through sub-grant



program made possible by a grant to the Georgia Department of Natural Resources (GDNR) from the National Oceanic and Atmospheric Administration (NOAA) through congressional funding pursuant to the Coastal Zone Management Act. Each year, the Georgia Coastal Management Program (GCMP) allocates a portion of its federal funding to the CIG Program. This program supports the objective of the GCMP: balancing economic development in Georgia's coastal area with preservation of natural, environmental, historic, archaeological and recreational resources for the benefit of Georgia's present and future generations.

These sub-grants may be awarded to qualified county and municipal governments, regional commissions, state-affiliated research or educational institutions, or state agencies (except GDNR), provided the project takes place entirely within the eleven-county service area of the program. The CIG Program service area includes Brantley, Bryan, Camden, Chatham, Charlton, Effingham, Glynn, Liberty, Long, McIntosh, and Wayne counties.

More information about the CIG Program can be found at: <http://coastalgadnr.org/cm/grants/cig>

## 5.5.5 Other Funding Sources

### 5.5.5.1 GENERAL OBLIGATIONS BONDS

Debt financing of capital and operation and maintenance costs can be accomplished through issuing general obligation bonds, revenue bonds, or a combination of the two. A bond issue requires voter approval on a referendum ballot and is subject to local administrative policy in the form of debt ceilings. Most stormwater project debt has been financed through issuance of 15-year term bonds. These bonds are repayable from service charge proceeds, general revenues, and other sources (e.g. development fees), depending on the type of debt issued.

### 5.5.5.2 DEVELOPMENT IMPACT FEES

This funding source involves the assessment of a development impact fee on developers of new projects within a defined watershed or area. The project's total share of costs is determined not by the benefits received but by the impacts it creates in requiring new facilities and/or increased service levels. Development impact fees may be assessed as a permit or plan review fee. These are generally one-time fees, the revenues of which are used specifically to finance new stormwater facilities or other system components. While paid by the developer, these type of costs are typically passed on to the property owner(s).

A variation of the development impact or permit fee approach commonly used by small jurisdictions is the use of a private consultant to conduct plan reviews, construction inspections, and maintenance inspections. Using this scenario, the consultant would directly bill the developer for all services rendered. Ongoing maintenance inspections could be billed to the local jurisdiction. This type of arrangement typically results in a very low implementation cost to the community.

### 5.5.5.3 SPECIAL ASSESSMENTS/TAX DISTRICTS

A community may create special tax (or local improvement) districts to develop stormwater control systems. This approach is good in cases where capital improvements, land acquisition, special studies, and/or extraordinary maintenance benefits a specific area or number of properties within a jurisdiction. The result is that only those

who benefit from the systems pay for them. Special districts function as quasi-municipal corporations created by law. As such, these districts have several funding options available: special taxes on property within the district area, development fees, user fees and, in some instances, debt financing. Creation of these districts requires voter approval. An alternative to creating these districts is to develop basin-specific user fees through a stormwater utility.

## 5.6 Adapting the Program to Meet Local Needs and Challenges

**Description:** Georgia communities vary significantly in terms of environment, as well as past and future growth conditions. Therefore, it is important for each community to customize its stormwater management program to meet its local needs and challenges.

### KEY CONSIDERATIONS

There are several factors worth considering that may require local customization or modification of a local stormwater management program, including:

- Historic Rainfall and Flooding Concerns
- Climate Change
- Land Use Patterns and Zoning Requirements
- Anticipated Development and Population Growth
- Typical Terrain and Soil Conditions

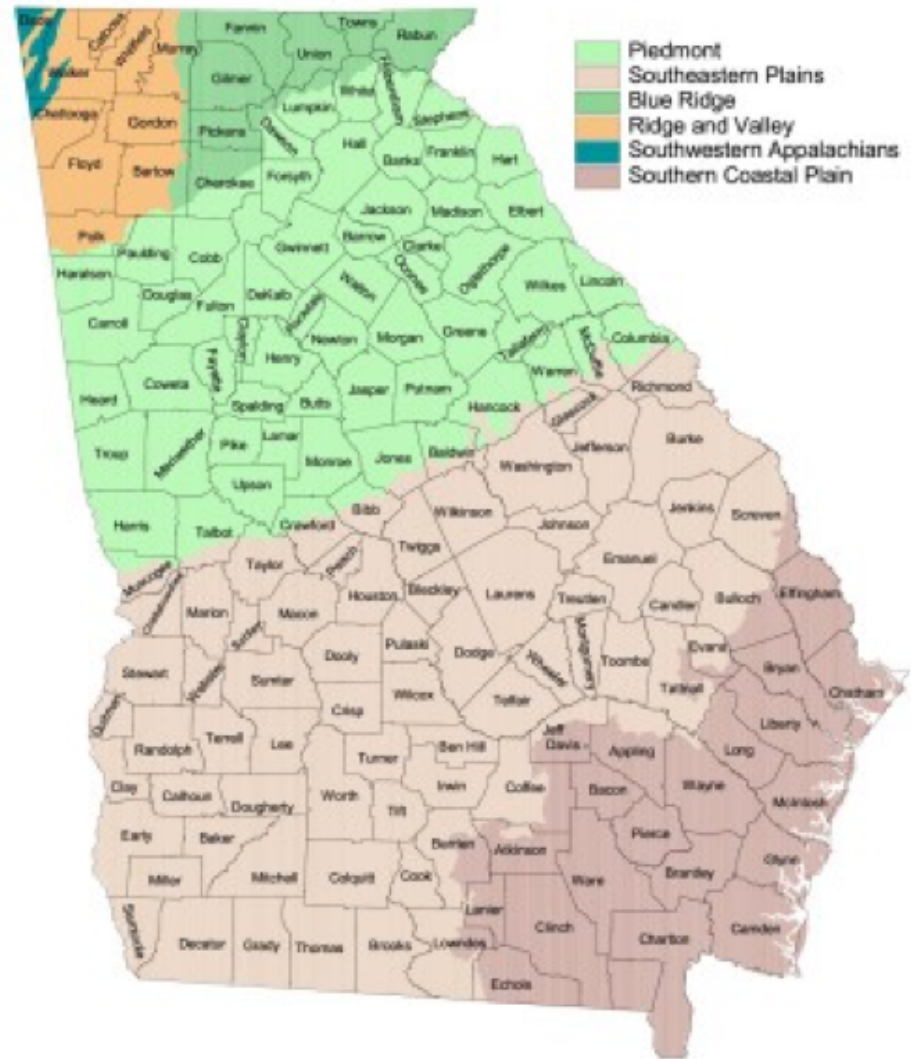

### 5.6.1 Introduction

Adapting a stormwater management program to meet local needs and challenges is an important step that requires extensive planning and forethought. A community must consider environmental factors such as flooding and hurricanes, regional factors such as proximity to the coast and presence of karst, and future growth conditions and patterns. In addition, a community must determine the best approach for implementing and building political and public support for the program. The goal of this section is to provide an overview of the necessary steps for adapting a stormwater management program to meet the local needs and challenges of a community.

### 5.6.2 Environmental Factors

Identifying the location and magnitude of existing and/or potential stormwater-related problems including flooding, property damage, water quality impairment, streambank erosion, and habitat degradation is the first step in adapting a stormwater management program to the community.

Local governments should obtain geographical information to help determine which areas are contenders for new development and which areas should be avoided. The following information should be gathered to help with this process:

- Maps
  - » Watersheds
  - » Floodplains
  - » Soils

- » Land use
- » Land cover
- » Water resources (rivers, lakes, wetlands, etc.)
- » Source water protection areas
- » Roads
- Precipitation

- Areas prone to flooding

When thinking about future conditions, climate change should be considered, since it could potentially affect the ways stormwater will be generated and treated in both the piedmont region and the coastal region. Climate change is anticipated to impact every aspect of the water cycle, and many of the underlying assumptions that stormwater managers use for runoff and storm system design might become outdated if these predictions become a reality. Changes in water elevation, storm intensity, and storm duration can impact the stormwater management program's LID placement, design variables (such as the design storm, water quality volume, and stormwater conveyance), and other considerations needed to account for changing climate and associated impacts. To review the predicted impacts of climate change on the State of Georgia, see the National Climate Assessment's Climate Change Impacts in the United States: <http://nca2014.globalchange.gov/>

Since there is still significant uncertainty regarding climate change's impacts on rainfall and stormwater management, it is difficult to recommend

specific changes to BMP design standards. It is better to focus on broader LID design principles that build system resiliency for climate change, including designs and approaches that:

- Enhance storage and treatment in natural and vegetated areas;
- Use small-scale storage and treatment; and
- Provide conveyances that allow for a margin of safety for high flows.
- Provide greater stream and floodplain buffers and setbacks. (Ellis, et al)

## Climate Variability and Stormwater Systems

Between 2006 and 2012, the Upper ACF Basin alone experienced four extreme weather events: the Drought of 2007-2008, which brought record-high temperatures and severe losses from local reservoirs; the September Flood of 2009, which caused widespread flooding and raised the Chattahoochee River to the 500-year flood level; the subsequent Winter Floods of 2009-2010; and the Drought of 2011-2012 (Beller-Sims et al, 2014, pg. C-1). With the expectation that similar extreme events will continue to occur in addition to shifting annual averages (C-4), communities, engineers, and scientists have increasingly recognized the role of climate variability in the long-range design of stormwater infrastructure and begun to pursue measures that create resilient systems capable of withstanding a range of potential climate conditions (1-3).

Stormwater management is an important element of a comprehensive climate adaptation strategy, and the climate action plans of Seattle, Miami-Dade County, New York City, and Chicago, among others, acknowledge the role of green infrastructure and other stormwater management practices to mitigate the broad effects of climate change (Seattle Office of Sustainability & Environment, Miami-Dade County, City of Chicago). These efforts are not restricted to large urban areas; jurisdictions of all size are implementing similar initiatives, including communities like Beaverton, Oregon, Dubuque, Iowa, and small coastal communities facing the immediate consequences of inaction (Resilient Communities for America, 2013).

Though there is some disagreement among climate studies regarding the exact nature of the localized climate impacts upon precipitation and hydrology across the state, communities and water utilities locally and nationally have begun to implement strategies to manage the risk of extreme events and, more broadly, future climate variability (US EPA, 2013, pg. 10). In 2013, the Metropolitan North Georgia Water Planning District (the District) undertook a utility climate resiliency study to assess the impact of climate variability upon water resources and infrastructure in the metropolitan Atlanta area (CDM Smith, 2015, pg. 1-1). The study used 108 projections from the CMIP5 ensemble of climate models to develop five representative scenarios of potential future climate conditions: hot/dry, hot/wet, warm/wet, warm/dry, and the central tendency. This approach allowed the District to evaluate a suite of potential futures that represent the uncertainty and variability of the available climate projections (2-3). Based on the projected climate outcomes, that study recommended a range of adaptation strategies for planners, designers, and managers of water, wastewater, and stormwater infrastructure systems. Other studies from the Georgia Institute of Water Resources, which predict more frequent droughts and extreme precipitation events across the ACF basin, support the need for resilient systems (Beller-Sims et al, 2014, pg. C-4).

The performance of stormwater conveyance systems is sensitive to changes in precipitation and peak flow. Particularly, an increase in the 24-hour storm depth or a decrease in the average

recurrence interval (ARI) of precipitation events may overwhelm those systems designed with conventional design storm depths. Stormwater outfalls may also become submerged by floodwaters and high peak streamflow, cause backflow into the system, and ultimately create upstream flooding. Additionally, climate variability can lead to increased loadings of nonpoint source pollutants, which may affect the ability of stormwater systems to meet applicable water quality standards in the receiving water body (CDM Smith, 2015, 4-27). Prolonged or severe drought can impact the integrity of existing infrastructure, which can be compromised by roots seeking moisture during times of drought, and the performance of CSO systems constructed with the expectation of higher flows (Cromwell and McGuckin, 2010, pg. 25).

Some adaptation strategies have been identified to protect against the impact of climate variability and build resiliency in local stormwater conveyance systems. The District's study described some general actions to prepare for future climate variability:

- Increase the capacity of stormwater collection, conveyance, and storage systems;
- Incorporate green infrastructure to promote infiltration and reduce stormwater volumes;
- Conduct extreme precipitation event analyses with climate variability to understand the risk of impacts to the stormwater collection system;
- Monitor and inspect the integrity of existing infrastructure (5-12).

## Climate Variability and Stormwater Systems - (Con't)

Decreasing return periods for storm events can significantly impact the performance of stormwater infrastructure. The District study predicted an increase in storm depths by -2 to 12% and peak streamflow by -2 to 11% around the Atlanta metropolitan area (CDM Smith, 2015, 4-19). In response, engineers can anticipate this change and provide greater protection by designing hydraulic structures for more extreme events (50-year storm vs. 25-year storm) and incorporating green infrastructure and infiltration practices in site and system designs. The uncertain impacts of climate change also support the use of environmental site design and the inclusion of green infrastructure to build capacity throughout the system and redirect flow from undersized conveyance systems. From a planning perspective, utilities and managers should monitor and track local climate data to identify changing conditions, evaluate the system's performance, and prioritize critical adaptations to best improve the system response (Ellis et al, 2014, pg. G-2). The usefulness of these strategies is not limited to the District or the ACF basin; they build resilience to a range of climate futures, independent of the geographic context.

Coastal communities are also uniquely vulnerable to the effects of tidal flooding and sea level rise. The existence of aging stormwater infrastructure and sea level rise pose a dual threat to coastal communities. For example, submerged outfalls

can cause inundation in low-lying areas, even those located behind flood protection structures, and cause corrosion in pipes (Cromwell and McGuckin, 2010, pg. 21). Hard armoring and shoreline stabilization strategies can mitigate the effects of sea level rise upon inland structures. At-risk structures and proposed outfalls can be raised above the expected flooding level, and low-lying segments may be retrofitted with gates and pumps to prevent back up through the stormwater system (Keating and Habeeb, 2012, pg. 110). NOAA's Adapting to Climate Change: A Planning Guide for State Coastal Managers recommends a suite of strategies to regularly evaluate the system and build capacity for additional flooding to anticipate future need.

Other approaches that create resiliency, redundancy, and reliability are also recommended to be integrated in all areas of stormwater management, including planning, operations, and infrastructure to prepare for a range of possible climate futures that may feature both drought and extreme precipitation (Cromwell and McGuckin, 2010, pg. 18). The effects of climate change upon the design criteria of stormwater systems are complex, but early adoption of basic measures to build resiliency and an operations framework to proactively identify climate threats can mitigate the impact of variability across a broad range of climate futures. Simply, early preparation and recognition are key to protecting the future performance of stormwater systems.

## References

Beller-Simms, N., E. Brown, L. Fillmore, K. Metchis, K. Ozekin, C. Ternieden, and K. Lackey. 2014. *Water/Wastewater Utilities and Extreme Climate and Weather Events: Case Studies on Community Response, Lessons Learned, Adaptation, and Planning Needs for the Future*. Project No. CC7C11 by the Water Environment Research Foundation: Alexandria, VA.

CDM Smith. 2015. *Utility Climate Resiliency Study*. Metropolitan North Georgia Water Planning District.

City of Chicago. 2010. *Chicago Climate Action Plan*. City of Chicago Climate Action Plan. <http://www.chicagoclimatereaction.org/filebin/pdf/final-report/CCAPREPORTFINALv2.pdf>.

Cromwell, John and Robyn McGuckin. 2010. *Implications of Climate Change for Adaptation by Wastewater and Stormwater Agencies*. Water Environment Federation Technical Exhibition and Conference 2010. pp. 1887-1915

Ellis, K., C. Berg, D. Caraco, S. Drescher, G. Hoffmann, B. Keppler, M. LaRocco, and A. Turner. 2014. *Low Impact Development in Coastal South Carolina: A Planning and Design Guide*. ACE Basin and North Inlet – Winyah Bay National Estuarine Research Reserves, 462 pp.



## References - (Con't)

Keating, Larry and Dana Habeeb. 2012. *Tracking the Effects of Sea Level Rise in Georgia Coastal Communities*. Georgia Institute of Technology, School of City and Regional Planning.

Miami-Dade County. 2010. *Climate Change Action Plan*. Miami-Dade County GreenPrint. [http://www.miamidade.gov/greenprint/pdf/climate\\_action\\_plan.pdf](http://www.miamidade.gov/greenprint/pdf/climate_action_plan.pdf).

O'Neill II, James A. 2010. *Climate Change's Impact on the Design of Water, Wastewater, and Stormwater Infrastructure*. *Hydrology Days 2010*.

Resilient Communities for America. 2013. *Local Governments, Extreme Weather, and Climate Change*. Media Kit of the Resilient Communities for America Campaign. [http://www.resilientamerica.org/wp-content/uploads/2013/06/RC4A\\_Cities\\_extreme\\_weather\\_climate\\_fact\\_sheet.pdf](http://www.resilientamerica.org/wp-content/uploads/2013/06/RC4A_Cities_extreme_weather_climate_fact_sheet.pdf).

Seattle Office of Sustainability & Environment. 2013. *Seattle Climate Action Plan*. [http://www.seattle.gov/Documents/Departments/OSE/2013\\_CAP\\_20130612.pdf](http://www.seattle.gov/Documents/Departments/OSE/2013_CAP_20130612.pdf).

US EPA. 2013. *Climate Ready Water Utilities Adaptation Strategies Guide for Water Utilities*. U.S. Environmental Protection Agency, Washington, DC, EPA/817/K-13/001.

### 5.6.3 Regional Factors

There are many regional factors that can affect the development of a stormwater management plan. The State of Georgia is made up of six ecoregions, each having its own geographical characteristics. Most stormwater management practices were originally developed for use in the Piedmont Region, however as shown in Figure 5.6-1 there are other regions, including the Southeastern Plains, Blue Ridge, Ridge and Valley, Southwestern Appalachians, and Southern Coastal Plain, which may require variations and modifications to these practices. Regional issues, such as coastal, karst, and watersheds containing water supply districts, all need to be considered when adapting a stormwater program to a community.

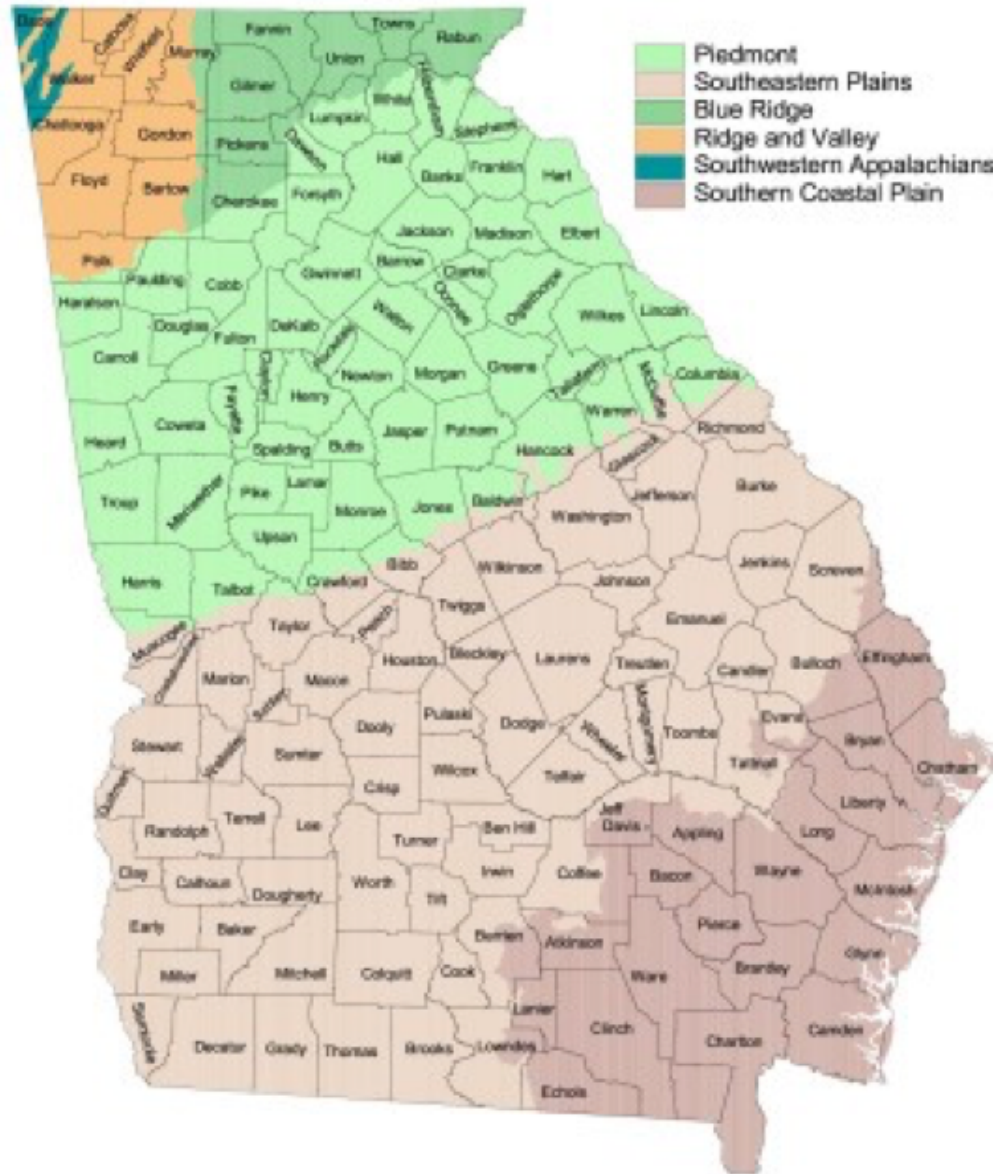

Figure 5.6-1 Georgia Ecoregions  
(Source: Georgia DNR)

### Coastal

Flat terrain, high water table, and various soil types are just a few physical features that must be considered in the coastal region. The surface water/groundwater interactions increase and the head available to treat the stormwater or move floodwaters through the watershed during intense tropical storms and hurricanes decreases due to the flat terrain present in the coastal region. Since the water table exists within a few feet of the surface, the movement of pollutants is increased through shallow groundwater causing a decrease in performance of stormwater management practices. Poorly-drained soils and well-drained soils can both be found in the coastal region. Since infiltration rates can vary greatly between each of these soil types, it is important to consider the effectiveness of certain stormwater BMPs.

### Karst

Karst is a dynamic landscape composed of soluble bedrock that is associated with sinkholes, springs, caves, and a highly irregular soil-rock interface. Specific site and BMP design considerations are required in areas of karst geology. The best approach for the community is to create stronger comprehensive land use plans that direct new growth away from karst areas to more appropriate locations. In situations where an entire community is underlain by karst, it would be critical to implement geotechnical investigation requirements aimed at minimizing the impacts of land development on the natural drainage patterns. (1)

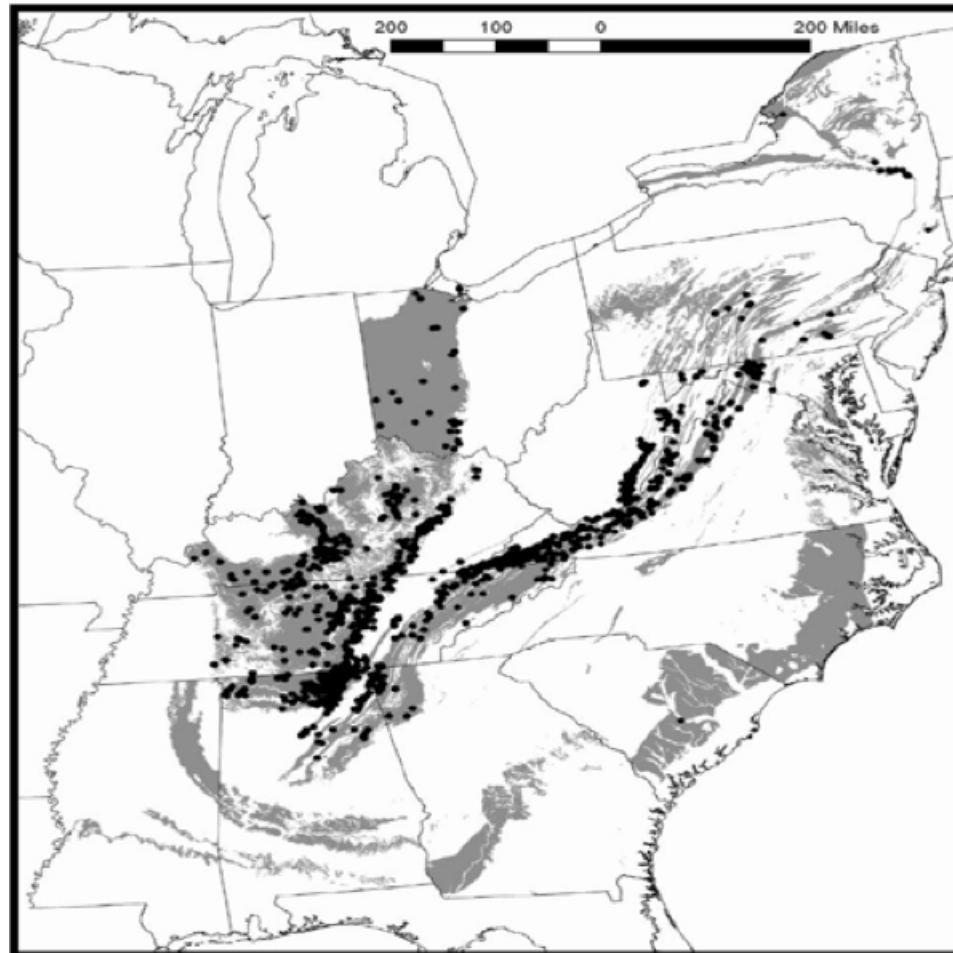

Figure 5.6-2 Karst Terrain Distribution: grey = karst, black = caves  
(Source: CSN Technical Bulletin; Weary, 2005)

### Water Supply Regions

When adapting the stormwater management program to your community, it is important to consider what watershed, or river basin, your community is located in and how the drinking water is supplied (see Figure 5.6-3). Much of the water supply in Georgia is supplied by surface waters from rivers and storage reservoirs. Care must be taken when directing growth and development of the community to these areas. In addition, stormwater management controls should be effective in protecting existing surface waters and storage reservoirs that supply this water. Low impact development practices that reduce sediment and other pollutants in water supply sources will also help reduce the cost of treating drinking water.

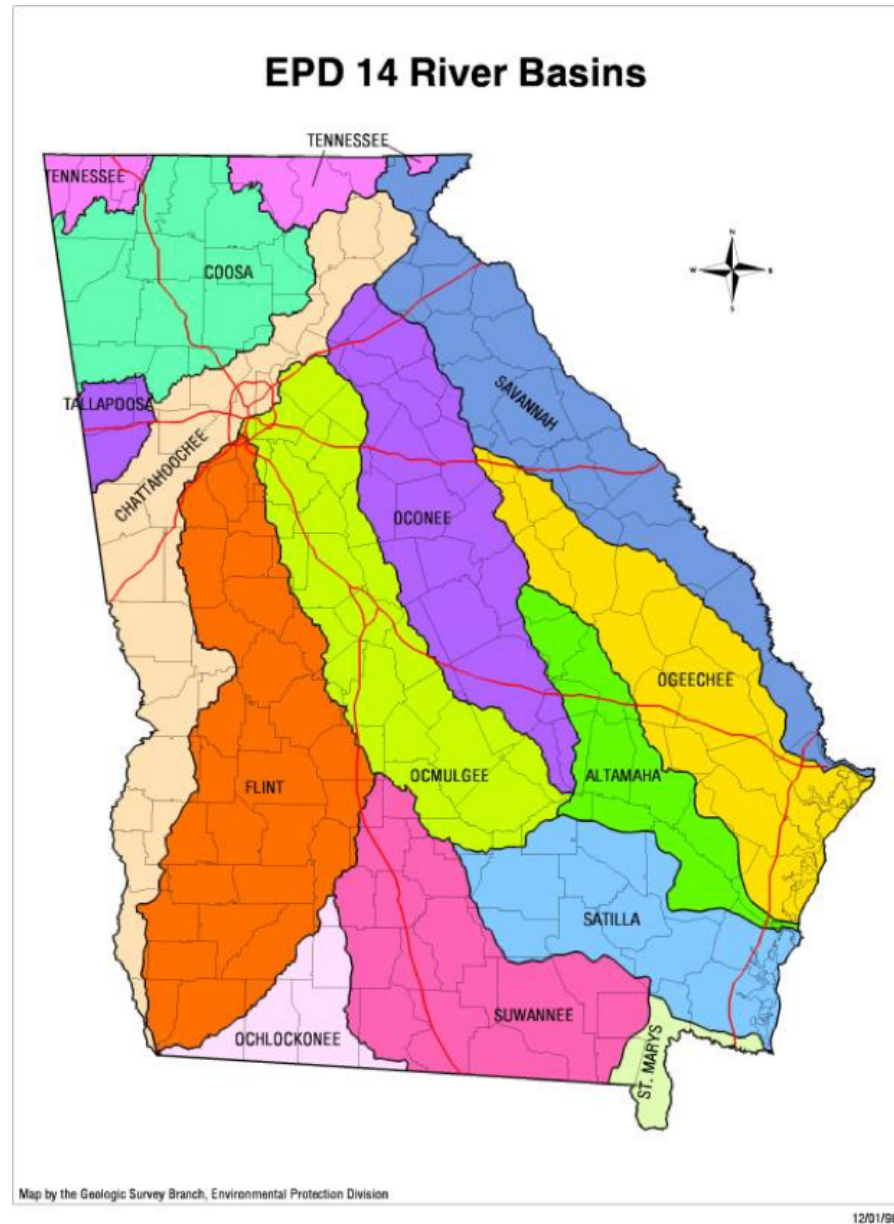

Figure 5.6-3 Georgia River Basins  
(Source: Geologic Survey Branch, EPD, 1995)

### 5.6.4 Past Growth Conditions and Patterns

All types of land use pose their own challenges when it comes to implementation of stormwater BMPs, particularly LID practices. Past growth conditions and patterns of a community may affect which types of BMPs are easiest or most appropriate to implement. For example, in urban, heavily developed areas, land prices can be very high, making it difficult to find available space for large BMPs. On the other hand, in more suburban or rural areas finding available space may be less of a challenge, but other constraints, such as the presence of septic fields and wells, or a lack of drainage infrastructure for underdrain connection may exist. It is important to consider the existing development conditions when customizing a local stormwater management program. Rural areas may have the most to gain in adopting new runoff reduction stormwater management approaches, especially when combined with comprehensive planning to preserve critical landscapes for managing water supply and quality. Early planning to preserve floodplains, wide stream buffers, and biologically important habitats, like wetlands, will help local governments avoid future costly flooding and water quality impairments as they grow, develop, and create communities where people wish to live and work.

### 5.6.5 Future Growth Conditions and Patterns

Another important step for communities to consider is future growth conditions and patterns. As discussed in [Chapter 3](#), implementing infill development and redevelopment in a community's land use regulations could encourage growth to be more centrally focused in city corridors, thereby reducing urban sprawl. Gathering current and historical information can help local governments identify areas for redevelopment and future growth. This information may include:

- Current population
- Anticipated population changes
- Current land use and zoning
- Proposed changes to land use
- Natural resources inventory
- Build-out analysis showing full development potential of existing zoning
- Impervious cover
- Construction projects (number, type, etc.)
- Transportation, utility, and infrastructure plans

### 5.6.6 Political and Public Support

The identification of stormwater-related problems or mandated requirements may lead to formal recognition by elected officials and establish a basis for developing the program. Program development should ideally be performed with a team from several departments to promote coordination and include the public in the process through the use of a stakeholder group.

All stormwater program goals should be based on problems that are clearly recognized as being important by the general public and that can be addressed through the basic powers and responsibilities of local government. Often a consensus-building approach is used to develop general program goals with citizen input. These goals often include the following general foundational responsibilities:

- Protect life and health
- Minimize property damage
- Ensure a functional drainage system
- Protect water quality
- Protect drinking water supplies
- Guide development
- Protect floodplain function
- Encourage economic development
- Protect and enhance the environment
- Improve quality of life

In order to gain public support for local stormwater management programs, citizens and the business community alike need to be educated and involved in the process. General education efforts can provide information about stormwater issues and pollution prevention practices. Educational efforts can include:

- Meetings and presentations
- Newsletters, fact sheets, and brochures
- Homeowner education materials
- Media campaigns
- Coordination with activist groups for program support

Further, programs like Georgia Adopt-A-Stream can involve local citizens in the cleanup and monitoring of local streams. The public can also be involved in the development of watershed plans and overall stormwater management policy.



## 5.7 Watershed-Based Stormwater Planning

**Description:** Programs that offer alternatives to on-site stormwater management programs can provide flexibility to encourage development and redevelopment in areas where on-site stormwater management is cost-prohibitive or otherwise very difficult.

### ! KEY CONSIDERATIONS

Alternatives to on-site stormwater management can include:

- Off-Site Mitigation, in which stormwater BMPs are constructed on a separate property, either as mitigation for forgoing on-site stormwater management, or as part of a regional stormwater management strategy.
- Fee-In-Lieu, in which a development pays a fee rather than constructing on-site stormwater management. The fees collected by the community are then used to pay for stormwater projects that have provided an equivalent level of protection.
- Offsets, Banking, and Trading, in which privately constructed stormwater BMPs may be used to offset developments that do not meet their stormwater regulations through selling or trading on a stormwater credit market.

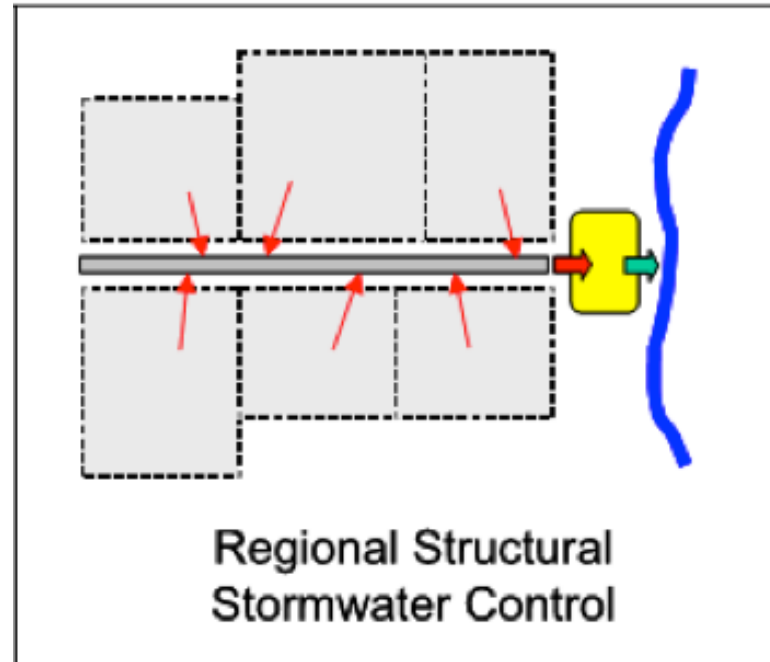

### 5.7.1 Introduction

A guiding principle of low impact development (LID) is to manage and treat stormwater as close to the original source of runoff as possible. However, there are situations in which this is either not feasible, or not the most practical approach. This section discusses alternatives to on-site stormwater management, including off-site and regional stormwater practices, fee-in-lieu, and credit banking and trading.

This is a general overview with a few examples. For more thorough coverage of off-site and watershed-based compliance programs, examples, and sample documentation, consult additional resources, such as *Guidance For Developing an Off-Site Stormwater Compliance Program in West Virginia* ([http://www.dep.wv.gov/WWE/Programs/stormwater/MS4/permits/Documents/WV\\_Mitigation-FeeInLieu-Guidance\\_Final\\_Jan-2013.pdf](http://www.dep.wv.gov/WWE/Programs/stormwater/MS4/permits/Documents/WV_Mitigation-FeeInLieu-Guidance_Final_Jan-2013.pdf)) (CWP, 2012).

### 5.7.2 Advantages and Disadvantages of Alternative Approaches

When establishing alternative stormwater treatment options to on-site stormwater management, several considerations come into play. There are advantages and disadvantages to sub-watershed- or watershed-scale approaches for managing and treating stormwater. Generally, the advantages are associated with having increased options, and with the economy and efficiency of scale. Disadvantages are generally associated with administrative demands and constraints, as well as social and political perceptions and related difficulties.

#### Advantages

There are many cases where on-site stormwater management is either infeasible or impossible due to site or financial constraints. In ultra-urban environments, often development or redevelopment stormwater management criteria require significant space to implement, and can therefore become both difficult and expensive. Many regulatory guides allow exemptions to meeting the minimum criteria by using language like “if this cannot be achieved, treatment must be implemented to the maximum extent practicable,” meaning that as much as possible must be done. This often carries with it the option to pay a fee for any on-site mitigation that cannot be achieved. This will be discussed later in [Section 5.7.4 - Fee-In-Lieu](#). Allowing alternative mitigation provides for some equivalent of on-site mitigation to be achieved to a full extent, rather than the fullest practicable extent.

Another advantage for alternative mitigation is that it allows properties and areas to be used for water quality and quantity treatment that might have otherwise (a) lain dormant (like abandoned properties in urban areas) or (b) been developed in a way that contributes to negative impacts of increased runoff. For example, a parcel containing a dilapidated building that needs to be torn down could serve as the off-site location for structural stormwater practices installed to provide mitigation for runoff, offsetting the added runoff from a nearby parcel being developed or redeveloped.

#### Disadvantages

One potential concern is that the immediate or local impacts of stormwater runoff may not be resolved by treating stormwater elsewhere. For example, a site with certain runoff characteristics will in some way affect neighboring parcels. If the on-site runoff mitigation requirements are foregone in favor of some off-site treatment option, while the overall effect on the watershed may in fact be better than it would with full on-site treatment, the effects on the neighboring parcel are not affected by off-site mitigation. In addition, the other benefits of the on-site practice, such as habitat creation, green space addition, beautification, or air quality improvements may be lost. Often, regulations state that a certain portion of the required stormwater management practices be achieved on-site, with alternative compliance as an option for the remainder.

A second concern is that, administratively, there are more components involved in watershed-scale, or even neighborhood-scale mitigation options. With on-site treatment, there is essentially one owner of the practice, one BMP or BMP train, and the process for paying for, installing, maintaining, and repairing facilities is simpler. Once at the watershed scale, this relationship may include the site owner, potentially a neighborhood association, a locality, a municipality, and a separate utility or treatment provider. Potential conflict points include responsibility for maintenance, cost sharing and liability, and administrative burdens associated with larger scale efforts involving multiple stakeholders.

### Difficulties Associated With Scope and Boundaries

When attempting to address water quality and/or quantity issues in a particular watershed, exact geographic boundaries can be difficult to delineate. As previously mentioned, even drawing the boundary for mitigation at the neighborhood scale, two parcels within that neighborhood may have issues between them as runoff from one affects another. This gets even more difficult when expanding to the watershed scale. For example, if nitrogen is a pollutant of concern in a river, and a total maximum daily load (TMDL) is established for controlling it, the boundaries constraining off-site mitigation relationships can get very tricky. A pound of nitrogen deposited at the head of a tributary to the river is not the same as a pound delivered at the confluence of the tributary and the river, since a significant amount of nitrogen would have been biologically processed and removed from the water if it had traveled the length of the tributary. Therefore, careful consideration is necessary to determine how and where mitigation projects can be located. To be effective, mitigation projects must be able to provide as much benefit as any on-site projects would have.

Political and administrative boundaries can be equally difficult to establish cleanly. Using another example, if a water quality workgroup determined that fecal coliform loads were of particular concern in a lake, the stakeholders would be involved in maintaining water quality. Therefore, a system that allowed a development in one of the stakeholder counties to treat stormwater elsewhere to

offset on-site requirements might theoretically allow treatment somewhere in another one of the stakeholder counties, but the cross-county tracking and balancing could be cumbersome. It is possible, but a council with membership of the involved counties would need to be established so that they function as one collaborative entity. And to further complicate matters, for each goal – like a TMDL in a particular water body – there may need to be a governing body that is a collection of stakeholder entities.

If the alternative treatment system includes fee-in-lieu as an option, this can become more challenging, since it becomes difficult to assign portions of the cost liability to each of the entities associated with the larger system. A small-scale development in one stakeholder county might be able to pay a fee-in-lieu of on-site treatment, but would the fee go to that county, the larger council, or perhaps the operator of an online regional treatment facility closer to the lake? The answer to this question is to be answered by the group of municipalities and other administrative entities involved, and the process for establishing a system like this and making these determinations can be guided by some of the case studies offered in this section.

<p>Some portion of stormwater management requirements must be met on-site. The remainder may be met by an alternative.</p>	<p><b>Example – Minimum on-site requirement:</b> There is a 1" retention requirement for water quality, 75% <i>must</i> be managed on-site, and the remaining 25% may be managed using an alternative.</p>
<p>The alternative compliance methods allowed may not be required in a 1:1 ratio.</p>	<p><b>Example – Factor of Safety:</b> There is a 1" retention requirement for water quality. If this cannot be met on-site, stormwater controls installed off-site must retain 1.2".</p>

**Table 5.7-1 Two common qualifying conditions for alternative stormwater management compliance**

### 5.7.3 Off-Site Mitigation

Small scale off-site mitigation – sometimes called “in-kind” – is an option to install some controls or treatment on a site that is not where the development or redevelopment is occurring, perhaps on an individual site-development scale. Once geographic boundaries and constraints are established, this may be offered as an option with some qualifying conditions.

A typical approach in many communities is for a developer to finance, design, and construct stormwater controls at the individual parcel level, or the neighborhood level. Initially, the developer is responsible for all costs, operation, and maintenance. Most municipalities require inspection and maintenance agreements to solidify responsibility of the owners to maintain proper function of the practices. Once properties are sold to individuals, ownership of those agreements, the practices, and their maintenance is passed on. However, if the owners fail to maintain the stormwater controls, the local government is likely to become responsible for them, especially if the controls are in public right-of-way or communal land.

One alternative approach is to install strategically located regional stormwater control facilities in a sub-watershed, rather than on-site controls. Regional Stormwater Management Practice (RSMP) facilities are an option, pre- or post-construction. These are designed to handle stormwater runoff from multiple projects and/or properties through a local jurisdiction-sponsored program, where individual properties or developments may assist in financing the construction, operation and maintenance of the facility, and the requirement for on-site controls is either eliminated or reduced (see Figure 5.7-1). If future development is already planned, preemptively siting and installing RSMPs can be easier. If development is already complete, finding an appropriate location for an RSMP may be difficult, due to size and property ownership constraints.

There is always an ongoing cost to managing stormwater, whether it is at the site scale or the regional scale. With regional facilities, though the per-unit cost of construction, operation, and maintenance is reduced, it is still significant and ongoing. In many cases, a community must provide capital construction funds for a regional facility, including the costs of land acquisition. However, if a downstream

developer is the first to build, the developer could be required to construct the facility and later be compensated by upstream developers for the capital construction costs and annual maintenance expenditures. Conversely, an upstream developer may have to establish temporary control structures if the regional facility is not in place before construction. Maintenance responsibilities generally shift from the homeowner or developer to the local government when a regional approach is selected. Many municipalities across the United States have established a stormwater utility or some other program to fund and implement stormwater controls.

Large-scale stormwater controls can be very cost effective. They can also be much more effective at removing pollutants of concern at the sub-watershed scale. However, an extremely effective and efficient RSMP may be better for the stream that eventually receives the discharge, but small tributaries upstream of that larger receiving stream might suffer due to lack of treatment or runoff reduction before discharge reaches them. It is important to ensure that improving one water body is not accomplished at the cost of harming another.

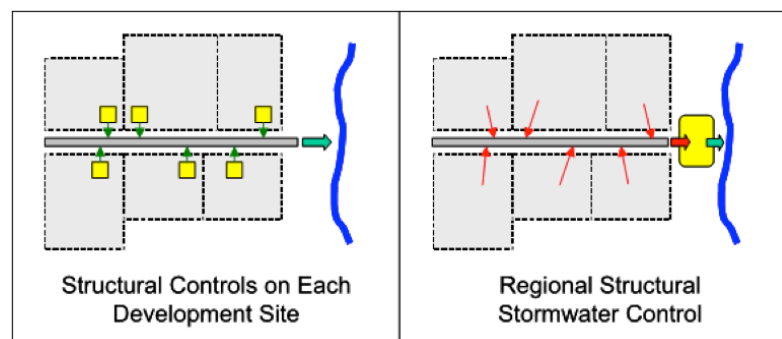

Figure 5.7-1 Difference between on-site and regional stormwater controls



## CASE STUDY

### Regional Stormwater Treatment in the St. Johns River

The St. Johns River watershed in north-east Florida has two regional stormwater treatment (RST) facilities, one in St. Johns County, and one in Putnam County. These RST facilities were funded by a cooperative effort, each costing approximately \$3.8 million to construct. The goal of these facilities is to reduce nitrogen, phosphorus, and total suspended solids in the runoff being discharged into the St. Johns River. The tri-county agricultural area, including St. Johns, Putnam, and Flagler counties, produces a great deal of very nutrient-rich runoff from cropland, which contributes to algal blooms that may severely impact wildlife balance.

The Deep Creek West Regional Stormwater Treatment Area in St. Johns County, online since 2006, has a 15-acre wet pond and 38-acre constructed wetland in series to treat agricultural runoff, primarily from the upstream farmland. The Edgefield Regional Stormwater Treatment Area in Putnam County, online since 2007, consists of a 25-acre wet pond and 56-acre constructed wetland in series.

Source: <http://floridaswater.com/lowerst-johnsriver/regionalstormwater.html>

### 5.7.4 Fee-In-Lieu

Fee-in-lieu is, as the name suggests, a program where an entity with the responsibility of managing stormwater runoff pays a fee in lieu of physically managing the runoff. Based on the municipal-level cost of treatment, either in larger facilities, retrofit efforts, or non-structural or programmatic efforts, a representative cost of treating stormwater can be established, and that money can go to larger scale and more efficient practices being implemented. For example, a municipal separate storm sewer system (MS4) may be investing money in stream restoration and street sweeping to achieve their intended water quality goals. The fees they charge in a fee-in-lieu program will fund those broader efforts, selected for their watershed benefits. See Chattanooga, Tennessee's system example in the next subsection.

The similarity between these fee-in-lieu payments and the stormwater utility fees many local governments are now collecting is that they fund the same types of programs and efforts. A major difference is that the stormwater utility fees are being collected from existing residential, commercial, and industrial property owners within an MS4 boundary regardless of when the construction occurred.

### 5.7.5 Offsets, Banking, and Trading

Allowing off-site mitigation and compliance opens up the possibility of establishing an offset trading system. In a stormwater offset and banking system, one entity funds or builds stormwater management practices for purposes other than, or in addition to, meeting their stormwater management requirements, and can transfer or sell the credits to another entity that has difficulty meeting their own requirements on-site. Stormwater banking offers opportunities to reduce the costs of stormwater permit compliance and facilitate local water quality improvements. When coupled with local incentives, such a system can open up an inventory of properties that would not have otherwise been targeted for redevelopment or restoration.

Larger-scale or overbuilt practices can earn credits for any treatment beyond what is necessary or required. These credits can be "banked" (saved) or sold in a managed marketplace. For sites where on-site mitigation is difficult or expensive, credits can be purchased, often for less money than an on-site structural practice would cost. If payment in lieu of direct (on-site) mitigation is an option, those fees will set a cap for the credits in a free marketplace. For example, Chattanooga, Tennessee has a fee-in-lieu option that is volume-based and set at 1.5 times the estimated on-site construction cost for BMPs. Boundaries for trading need to be set, and will likely be formed by local water resource regulations. Typically, these will be watershed or sub-watershed scale boundaries.



## CASE STUDY

### Chattanooga, TN Fee-in-lieu

Credits are available to anyone who manages more than the minimum required volume at a 1:1 ratio. If 1,000 cubic feet of retention is required on a site, and a BMP is installed that retains 1,500 cubic feet, that installer can receive credit "coupons" for 500 cubic feet, and sell those. The estimated construction cost, according to Chattanooga, is \$30 per cubic foot of retention. In addition, Chattanooga charges \$45 per cubic foot as a fee-in-lieu. Thus, the owner of the 500 cubic feet of credits could sell or transfer those credits, but would not be able to receive more than \$22,500 for them (\$45 x 500 cubic feet). Most likely, the cost on the marketplace would be somewhere between \$30 and \$45 per cubic foot.

For more on Chattanooga's stormwater ordinance, [visit their Credits and Incentives Manual](#).



## CASE STUDY

### Gwinnett County Wetland Mitigation Bank

For over 15 years, Gwinnett County has implemented a progressive watershed improvement program to evaluate and improve water quality in concert with a suite of other stormwater management practices. As part of this program, the county partnered with the Georgia Piedmont Land Trust to implement a stream and wetland restoration project downstream of Old Norcross Road on Sweetwater Creek in a highly urbanized area. The project included 2,000 feet of restored stream channel and restoration/creation of a total of 6 acres of wetlands.

Gwinnett County coordinated with the United States Army Corps of Engineers in order to use the restored segments of Sweetwater Creek and its tributaries and wetlands as a mitigation bank for use by Gwinnett County. The mitigation credits accrued from the project may be used by the county to offset unavoidable impacts to wetlands and waters of the United States. Revenue generated from the sale of credits will then be used to fund additional watershed improvements to improve and protect water quality conditions of streams throughout the County.

This unique urban mitigation banking model provides a true watershed approach by incorporating the Countywide Watershed Improvement Program to promote improvement of water quality and reduction of sediment/pollutant loads. Furthermore, development of a banking instrument for this project provides a strategy for addressing the needs of Gwinnett County by enhancing and protecting stream and wetland buffers, improving stormwater quality and volume control, stabilizing degraded stream channels and unstable stream banks, and acquiring land for preservation.

Source: Gwinnett County



## CASE STUDY

### Creedmoor, NC Stormwater Offset Mitigation

Creedmoor, North Carolina lies within the Falls Lake watershed of the Durham metropolitan area. In 2011, the North Carolina Department of Environment and Natural Resources (NCDENR) established new regulations for the Falls Lake watershed. Stormwater management is required for new development, with minimum on-site requirements of 30% for site areas less than one acre, and 50% site areas greater than one acre. The remainder of the stormwater management requirements may be met by either implementing or funding off-site offset measures. These off-site offsets must meet at least the baseline nutrient loading rate reductions that would otherwise be achieved on-site.

Mitigation or offset credits can be purchased from either the North Carolina Ecosystem Enhancement Program (NCEEP), or one of the Department of Water Quality (DWQ) approved mitigation banks. Mitigation must be provided and traded within the sub-watershed of interest; projects in the upper Falls Lake watershed must receive mitigation credits established within the upper Falls watershed, and not the lower Falls watershed, for example.

Sources: [http://portal.ncdenr.org/web/wq/home?p\\_p\\_id=20&p\\_p\\_lifecycle=1&p\\_p\\_state=exclusive&p\\_p\\_mode=view&\\_20\\_struts\\_action=%2Fdocument\\_library%2Fget\\_file&\\_20\\_folderId=5060450&\\_20\\_name=DLFE-43717.pdf](http://portal.ncdenr.org/web/wq/home?p_p_id=20&p_p_lifecycle=1&p_p_state=exclusive&p_p_mode=view&_20_struts_action=%2Fdocument_library%2Fget_file&_20_folderId=5060450&_20_name=DLFE-43717.pdf)

[http://www.durhamnc.gov/agendas\\_new/2011/cws20110815/289371\\_7934\\_403550.pdf](http://www.durhamnc.gov/agendas_new/2011/cws20110815/289371_7934_403550.pdf)



### 5.7.6 Conclusions

With several options and methods for managing stormwater, alternatives to on-site management are available and feasible. Off-site mitigation, mitigation fees, regional stormwater management practices, credit (or offset) banking and trading, or perhaps new and innovative programs are all options for managing stormwater runoff at the watershed scale. With big picture focus comes big opportunity; larger systems, despite their difficulties, can offer significant benefits when implemented properly. The information provided above is not intended to be an exhaustive review of all of the options or potential advantages and disadvantages for alternatives to on-site stormwater management. Communities should research the available options and select an approach that best meets their needs and goals.

In some states, a wastewater treatment plant (WWTP) that is not meeting its effluent water quality goals can purchase credits from another WWTP that is overachieving theirs. Similarly, most MS4s have limited public land on which to

implement stormwater controls, and consolidating monies and efforts incentivizes private land owners with viable green infrastructure opportunities to do more than required and profit by doing so. Also, practices that are very expensive, such as stream restoration, have been shown to be very cost effective when compared on a cost per pound of pollutant removed basis. The initial capital threshold can be overcome when fees are paid in by those private land owners and developers that either cannot meet their on-site requirements, or would rather eliminate the risk associated with uncertain site constraints and timelines.

## Savannah's Off-Site Credit Program

### Introduction

In April 2011 Georgia's Department of Natural Resources Board codified the Coastal Stormwater Supplement (CSS) to the Georgia Stormwater Management Manual. This occurred at about the same time as Georgia EPD issued new Phase I MS4 NPDES permits for coastal Georgia communities. Revised MS4 permits required stormwater management practices at least as stringent as the CSS. Consideration of the Runoff Reduction Volume (RRv) described in the CSS was a significant new requirement for land development in Georgia's coastal MS4s. As the RRv also applies to redevelopment, it is a challenge for site plan reviewers and developers on city historic district projects. The City of Savannah's experience presents a good case study on providing the RRv and allowing historic district redevelopment to continue.

### Description

Savannah's historic district is a defined area of downtown Savannah with specific zoning and development standards. This leads to several challenges with regard to stormwater management.

Zero setback zoning requirements in the Historic District impact the placement of buildings and parking lots. Zoning codes define the placement and extent of green space on parcels. Lot size and land cost further impact the availability of pervious surface to accommodate new green space and the RRv. Faced with redevelopment plans within

the Historic District whose only option was to seek a variance of the RRv requirement, the City of Savannah chose to use the off-site credit provision of the Stormwater Management Ordinance. Savannah's ordinance derives from the Coastal Supplement's model ordinance and states:

All stormwater management design plans shall include on-site stormwater management practices, unless arrangements are made with the Stormwater Management Director to manage post-construction stormwater runoff in an off-site or regional stormwater management practice. The off-site or regional stormwater management practice must be located on property legally dedicated to that purpose, be designed and sized to meet the post-construction stormwater management criteria presented in the City of Savannah Local Design Manual, provide a level of stormwater quality and quantity control that is equal to or greater than that which would be provided by on-site green infrastructure and stormwater management practices and have an associated inspection and maintenance agreement and plan (City of Savannah Municipal Code Div. II Sec. 4-11031).

To prepare to use the off-site credit provision of the Stormwater Management Ordinance, three steps were required:



Figure 5.7-2 Property Map of downtown Savannah.

1. Provide and designate off-site GI/LID practices in the City right-of-way that meet the RRv requirement;
2. Update the Local Engineering Design Manual to include an application procedure for use of off-site credit; and
3. Amend the City Revenue Ordinance to allow the City to provide for a Stormwater Management Credit fee and accepting payment for provision of the off-site credit.

In addition, Georgia EPD sought an update to the City Stormwater Management Plan that presented the credits program, described under what circumstances the City would allow this approach, and summarized the City's method of accounting for credits available and used.



## CASE STUDY - (CON'T)

### Off-site GI/LID Program

In order to collect a fee-in-lieu for stormwater detention, (the City attorney advised that) existing detention structures would need to be in place. A City Streets Department program of brick street replacement with permeable pavement and a City detail for permeable paver construction existed. Off-site management practices within the City right-of-way that were available were sections of brick streets that met the City's permeable pavement standard. At its initiation roughly 3000 square feet of streets were in the "bank".

The Local Design Manual was updated with the following standard:

When GI/LID is provided within the City ROW or property owned by the City in the same drainage basin as the redevelopment, equivalent runoff reduction volume (RRV) can be applied as credit to meet the redevelopment criteria.

At the same time the City prepared the following guidelines and criteria for off-site practices:

- They must provide a level of stormwater quality and quantity control that is equal to or greater than that which would be provided by on-site green infrastructure and stormwater management practices.
- The off-site areas must be in the same drainage basin as the redevelopment.

- The developer's stormwater management plan must demonstrate how it complies with the redevelopment criteria, the local design manual, the City Stormwater Ordinance, and the Coastal Stormwater Supplement.
- Off-site compliance credit is only available for Runoff Reduction Volume or pervious area offsets, and must be applied for through the Application for Off-Site Runoff Reduction Volume Credit in Appendix H of the local design manual.
- A fee-in-lieu contribution to fund the construction of pervious pavement systems or other GI/LID practices in the public right-of-way to benefit redevelopment must be paid to the City before a "certificate of occupancy" can be issued.

A copy of the credit application is provided as Figure 5.7-3 in this case study.

### Costs

The City's revenue ordinance was revised to establish the fee for purchasing credits to allow a developer to meet pervious surface requirements based on a square foot or cubic foot charge as follows:

- \$28.65 per square foot
- \$59.68 per cubic foot

The square foot charge allows a redevelopment to acquire square feet of pervious surface to meet the City's 20% pervious surface exemption from RRV for redevelopment. The cubic foot charge is for the RRV calculated for the project. Fees established by the City Revenue Ordinance included City permeable pavement installation cost and maintenance, to include resetting the pavers once and monthly street sweeping over a 20-year paver life.

### Maintenance

GI/LID maintenance is critical to its efficiency and success at mitigating urban runoff's environmental impact. For green infrastructure in the city right-of-way, maintenance includes inspection for structural integrity and proper function, and regular cleaning. As a GI/LID practice, the MS4 permit requires documentation of inspection and maintenance with each year's NPDES Annual Report. Each green infrastructure project is identified in the City stormwater GIS inventory and scheduled for inspection as required. Regular inspection by the Streets Department also ensures the pavement's structural integrity. Savannah sweeps its historic district streets weekly and uses brush/vacuum sweepers. Their long-term effectiveness will be determined by the Stormwater Department's annual inspections.



Applicant Information		
Name	Email:	
Primary contact:	Title:	
Mailing Address		
City:	State:	Zip code:
Telephone number:	Cell number:	
Project Site Information		
Location/Address:	Property size (acres)	
Project name:	Plan number in ETRACK: ____ - _____ - Plan	
Watershed/Downstream discharge point:		
Application is for off-site RRV _____ or impervious area off-set _____ (check one)		
<i>Credit for off-site stormwater management is only available within city right-of-way or city-owned property.</i>		
Eligibility of off-site Compliance: Documentation of Infeasibility of On-site Compliance		
Please check each eligibility criterion that applies to this site		
<input type="checkbox"/> Too small/no an area outside of the building foot print		
<input type="checkbox"/> Soil contamination or other subsurface or geologic condition that creates risks or hazards to infiltration of water into the ground		
<input type="checkbox"/> Site use that is inconsistent with capture and reuse of storm water (explain below)		
<input type="checkbox"/> A physical condition that prohibits use of storm water infiltration practice (like seawall, slip piles, walls)		
<input type="checkbox"/> Other significant site constraints (explain below):		
(explain)		
Water Volume Calculations		
Off-site RRV Calculation		Off-site Pervious Surface Calculation
Total off-site Runoff Reduction credit applied for: (cuft)		Total off-site pervious surface credit applied for: (sf)
$RRC(\text{off-site}) [sf] = RRC(\text{onsite}) / 0.42$		
Total off-site Runoff Reduction required:		Total off-site pervious surface required:
$RRC(\text{total}) = RRC(\text{off-site}) + 0.20(RRC(\text{off-site}))$		$RRC(\text{total}) = RRC(\text{off-site}) + 0.20(RRC(\text{off-site}))$
Total Cost of purchased Run-off Reduction Volume to be managed off-site = \$		

Figure 5.7-3 Application for Redevelopment Runoff Reduction Volume Credit

## References

- Bacon, Lisa. Derry, William E., Grits, Michelle. 2001. *Technical Memorandum Compensatory Mitigation for Stormwater: An Evaluation of On-Site Mitigation Advanced Mitigation (Banking) and Environmental Credit Trading Approaches*. Washington Departments of Transportation and Ecology.
- Bayon, R. Bloomgarden, E. Kaiser, C. Levine, L. Wachowicz, K. Valderrama, A. 2013. *Creating Clean Water Cash Flows: Developing Private Markets for Green Stormwater Infrastructure in Philadelphia*. Natural Resources Defense Council. Philadelphia, PA
- Beller-Simms, N., E. Brown, L. Fillmore, K. Metchis, K. Ozekin, C. Ternieden, and K. Lackey. 2014. *Water/Wastewater Utilities and Extreme Climate and Weather Events: Case Studies on Community Response, Lessons Learned, Adaptation, and Planning Needs for the Future*. Project No. CC7C11 by the Water Environment Research Foundation: Alexandria, VA.
- Berahzer, S.I. 2014. *Approaches to Stormwater Management: Stormwater Utilities and Green Infrastructure*. Environmental Finance Center, University of North Carolina at Chapel Hill.
- CDM Smith. 2015. *Utility Climate Resiliency Study. Metropolitan North Georgia Water Planning District*.
- Center for Watershed Protection (CWP). 2012. *Guidance for Developing an Off-Site Stormwater Compliance Program in West Virginia*. Center for Watershed Protection. Elliott City, MD.
- Center for Watershed Protection. 2012. *West Virginia Stormwater Management and Design Guidance Manual*. West Virginia Department of Environmental Protection and CWP, Charlottesville, VA.
- Chesapeake Bay Foundation. 2015. *The Economic Importance of the Bay*. Chesapeake Bay Foundation. Annapolis, MD.
- City of Chattanooga. 2014. *Water Quality Program Credits and Incentives Manual*. City of Chattanooga, TN.
- City of Chicago. 2010. *Chicago Climate Action Plan*. City of Chicago Climate Action Plan. Chicago, Illinois.
- City of Creedmoor. 2011. *Local Stormwater Program for New Development*. City of Creedmoor. Creedmoor, NC.
- City of Durham. 2011. *Falls Reservoir Water Supply Nutrient Strategy: Stormwater Management for New Development*. City of Durham. Durham. NC.
- City of Seattle. *"21.33.040 – Stormwater facility credit program."* Municode. n.d. Web 2015.
- Ellis, K., C. Berg, D. Caraco, S. Drescher, G. Hoffmann, B. Keppler, M. LaRocco, and A. Turner. 2014. *Low Impact Development in Coastal South Carolina: A Planning and Design Guide*. ACE Basin and North Inlet – Winyah Bay National Estuarine Research Reserves.
- Environmental Protection Division, *"Chattahoochee River Basin TMDL Reports."* Environmental Protection Division. n.d. Web. 2015.
- ESRI News for Water & Wastewater. 2014. *Double Time in Georgia: Coweta County Public Utility District Moves Twice as Fast with ArcGIS on iPad*.
- Hirschman, David J., John Kosco. 2008. *Managing Stormwater in Your Community: A Guide for Building an Effective Post-Construction Program*. Center for Watershed Protection, Ellicott City, MD.
- Keating, Larry and Dana Habeeb. 2012. *Tracking the Effects of Sea Level Rise in Georgia Coastal Communities*. Georgia Institute of Technology, School of City and Regional Planning.
- Kurz, J.S. 2013. Proceedings of the 2013 Georgia Water Resources Conference, held April 10–11, 2013. University of Georgia, Athens, Georgia.

## References (con't)

Melillo, Jerry M., Terese (T.C.) Richmond, and Gary W. Yohe, Eds., 2014: *Climate Change Impacts in the United States: The Third National Climate Assessment. U.S. Global Change Research Program*, 841 pp. doi:10.7930/J0Z31WJ2.

Miami-Dade County. 2010. *Climate Change Action Plan*. Miami-Dade County GreenPrint.

National Association of Flood and Stormwater Management Agencies. 2006. *Guidance for Municipal Stormwater Funding*.

National Society of Professional Engineers Code of Ethics. 2007. *NSPE Code of Ethics for Engineers*.

O'Neill II, James A. 2010. *Climate Change's Impact on the Design of Water, Wastewater, and Stormwater Infrastructure*. Hydrology Days 2010.

Seattle Office of Sustainability & Environment. 2013. *Seattle Climate Action Plan*.

Seattle Public Utilities. "*Stormwater Facility Credit Calculator*." 2011. PDF file.

Resilient Communities for America. 2013. *Local Governments, Extreme Weather, and Climate Change. Media Kit of the Resilient Communities for America Campaign*.

UNC Environmental Finance Center. "*GA Stormwater Utility Dashboard*." Environmental Finance Center. n.d. Web. 2013.

US EPA. 2013. *Climate Ready Water Utilities Adaptation Strategies Guide for Water Utilities*. U.S. Environmental Protection Agency, Washington, DC, EPA/817/K-13/001.



# Appendix A: Contact Agencies for Stormwater Management Regulations and Programs

# Contact Agencies for Stormwater Management Regulations and Programs

## National Flood Insurance Act/Flood Disaster Protection Act

Contact Agency	Phone	Address
Federal Emergency Management Agency	770-220-5200	3003 Chamblee Tucker Road Atlanta, GA 30341

Website: <https://www.fema.gov/region-iv-al-fl-ga-ky-ms-nc-sc-tn#RegionIVContactInformation>

Contact Agency	Phone	Address
Georgia EPD – Floodplain Management Office	404-651-8496	2 Martin Luther King, Jr. Blvd. East Tower, Suite 1152, Atlanta, GA 30334

Website: <https://epd.georgia.gov/>

## Georgia Safe Dams Act

Contact Agency	Phone	Address
Georgia EPD – Safe Dams Program	404-463-1511	2 Martin Luther King, Jr. Blvd. East Tower, Suite 1362, Atlanta, GA 30334

Website: <https://epd.georgia.gov/>

## Municipal NPDES Stormwater Permit Program (Phase I and II)

Contact Agency	Phone	Address
Georgia EPD – Nonpoint Source Program	404-463-1464	2 Martin Luther King Jr. Drive Suite 1462 East, Atlanta, GA 30334

Website: <https://epd.georgia.gov/>

## Industrial NPDES Stormwater Permit Program

Contact Agency	Phone	Address
Georgia EPD – Nonpoint Source Program	404-463-1464	2 Martin Luther King Jr. Drive Suite 1462 East Atlanta, GA 30334

Website: <https://epd.georgia.gov/>

# Contact Agencies for Stormwater Management Regulations and Programs

## NPDES Stormwater Permits for Construction Areas

Contact Agency	Phone	Address
Georgia EPD – Nonpoint Source Program	404-463-1464	2 Martin Luther King Jr. Drive, Suite 1462 East Atlanta, GA 30334

Website: <https://epd.georgia.gov/>

## NPDES Municipal Wastewater Discharge

Contact Agency	Phone	Address
Georgia EPD – Wastewater Regulatory	404-463-1511	2 Martin Luther King Jr. Drive, Suite 1152 East Atlanta, GA 30334

Website: <https://epd.georgia.gov/>

## Erosion and Sedimentation Act

Contact Agency	Phone	Address
1) Georgia Soil and Water Conservation Commission	706-552-4470	4310 Lexington Road (30605) P.O. Box 8024 (30603) , Athens, GA

Website: <https://gaswcc.georgia.gov/>

Contact Agency	Phone	Address
2) State Soil and Water Conservation Districts	(contact above for your district)	

Contact Agency	Phone	Address
3) Georgia EPD – Erosion and Sedimentation Control Unit	404-463-1464	2 Martin Luther King Jr. Drive Suite 1462 East, Atlanta, GA 30334

Website: <https://epd.georgia.gov/>

# Contact Agencies for Stormwater Management Regulations and Programs

## Total Maximum Daily Load (TMDL) Program

Contact Agency	Phone	Address
US EPA – Region 4	404-562-9900	Sam Nunn Atlanta Federal Center 61 Forsyth Street, SW , Atlanta, GA 30303-8960

Website: <http://www.epa.gov/tmdl/forms/contact-us-about-impaired-waters-and-tmdls#reg4>

Contact Agency	Phone	Address
Georgia EPD – TMDL Modeling & Developing Unit	404-463-1511	2 Martin Luther King Jr. Drive Suite 1152, East Tower, Atlanta, GA 30334

Website: <http://www2.epa.gov/aboutepa/about-epa-region-4-southeast>

## River Corridor Protection

Contact Agency	Phone	Address
Georgia DCA – Office of Coordinated Planning	404-679-4940	60 Executive Park, South, NE Atlanta, GA 30329

Website: <http://www.dca.ga.gov/>

## Metropolitan River Protection Act

Contact Agency	Phone	Address
Atlanta Regional Commission (ARC)	404-463-3100	40 Courtland Street, NE Atlanta, GA 30303

Website: [www.atlantaregional.com](http://www.atlantaregional.com)

## Georgia Planning Act (Water Supply Watersheds, Groundwater Recharge Areas)

Contact Agency	Phone	Address
Georgia EPD – Watershed Compliance	404-463-1511	2 Martin Luther King Jr. Drive Suite 1152 East, Atlanta, GA 30334

Website: <https://epd.georgia.gov/>

# Contact Agencies for Stormwater Management Regulations and Programs

## Groundwater Management / Wellhead Protection Program

Contact Agency	Phone	Address
Georgia EPD – Watershed Compliance	404-463-1511	2 Martin Luther King Jr. Drive Suite 1152 East, Atlanta, GA 30334

Website: <https://epd.georgia.gov/watershed-protection-branch-technical-guidance>

## Source Water Assessment Program

Contact Agency	Phone	Address
Georgia EPD – Source Water Protection Unit	404-656-2750	2 Martin Luther King Jr. Drive Suite 1362 East Atlanta, GA 30334

Website: <https://epd.georgia.gov/watershed-protection-branch-technical-guidance>

## Coastal Management Program and Coastal Marshlands Protection Act

Contact Agency	Phone	Address
Georgia DNR – Coastal Resources Division	912-264-7218	1 Conservation Way Brunswick, GA 31520

Website: <http://coastalgadnr.org/>

## Section 404 of Clean Water Act and Section 10 Rivers and Harbors Act

Contact Agency	Phone	Address
US Army Corps of Engineers, Savannah District (for Central and Coastal Areas of State)	912-652-5279	100 W Oglethorpe Avenue Savannah, GA 31401
US Army Corps of Engineers, Atlanta Office (for North Area of State – top half of state)	678-422-2720	1590 Adamson Parkway The Plaza, Suite 200, Morrow, GA 30260

Website: <http://www.usace.army.mil/Missions/CivilWorks/RegulatoryProgramandPermits.aspx>

## Georgia Land Conservation Program

Contact Agency	Phone	Address
Georgia Environmental Finance Authority	404-584-1000	233 Peachtree Street NE, Harris Tower, Suite 900 Atlanta, Georgia 30303

Website: <http://gefa.georgia.gov/georgia-land-conservation-program>

# Appendix B: Stormwater Management Site Plan Review Checklists



# Example Checklist for Preliminary Stormwater Management Site Plan Preparation and Review

1. Applicant information
  - Name, legal address, and telephone number
2. Common address and legal description of site
3. Vicinity map
4. Narrative describing proposed project and post-construction stormwater management measures.
5. Existing and proposed mapping and plans (recommended scale of 1" = 50' or greater detail) which illustrate at a minimum:
  - Existing and proposed topography (minimum of 2-foot contours recommended)
  - Perennial and intermittent streams
  - Mapping of soils from USDA soil surveys
  - Boundaries of existing vegetation and proposed limits of clearing and grading
  - Location and boundaries of natural feature protection and conservation areas such as wetlands, lakes, ponds, and other setbacks (e.g., stream buffers, drinking water well setbacks, septic setbacks, etc.)
  - Location of existing and proposed roads, buildings, parking lots and other impervious areas
  - Location of existing and proposed utilities (e.g., water, sewer, gas, electric) and easements
  - Preliminary estimates of unified stormwater sizing criteria requirements
  - Preliminary identification and calculation of stormwater site design credits
  - Preliminary selection and location of structural stormwater controls
    - Location of existing and proposed conveyance systems such as storm drains, inlets, catch basins, channels, swales, and areas of overland flow
    - Flow paths
    - Location of floodplain/floodway limits and relationship of site to upstream and downstream properties and drainages
    - Preliminary location and dimensions of proposed channel modifications, such as bridge or culvert crossings
6. Hydrologic and hydraulic analysis including:
  - Existing conditions hydrologic analysis for runoff rates, volumes, and velocities showing methodologies used and supporting calculations
  - Proposed (post-development) conditions hydrologic analysis for runoff rates, volumes, and velocities showing the methodologies used and supporting calculations
  - Hydrologic and hydraulic analysis of the stormwater management system for all applicable design storms
  - Preliminary sizing calculations for structural stormwater controls including contributing drainage area, storage, and outlet configuration
  - Preliminary analysis of potential downstream impact/effects of project, where necessary
7. Preliminary erosion and sediment control plan that at a minimum meets the requirements outlined in the Manual for Erosion and Sediment Control in Georgia
8. Preliminary landscaping plans for structural stormwater controls and any site reforestation or revegetation
9. Preliminary identification of waiver requests

# Example Checklist for Final Stormwater Management Site Plan Preparation and Review

1. Applicant information
  - Name, legal address, and telephone number
2. Common address and legal description of site
3. Signature and stamp of registered engineer/landscape architect and designer/owner certification
4. Vicinity map
5. Narrative describing proposed project and post-construction stormwater management measures.
6. Existing and proposed mapping and plans (recommended scale of 1" = 50' or greater detail) which illustrate at a minimum:
  - Existing and proposed topography (minimum of 2-foot contours recommended)
  - Perennial and intermittent streams
  - Mapping of soils from USDA soil surveys as well as the location of any site-specific borehole investigations that may have been performed
  - Boundaries of existing vegetation and proposed limits of clearing and grading
  - Location and boundaries of natural feature protection and conservation areas such as wetlands, lakes, ponds, and other setbacks (e.g., stream buffers, drinking water well setbacks, septic setbacks, etc.)
  - Location of existing and proposed roads, buildings, parking lots and other impervious areas
  - Location of existing and proposed utilities (e.g., water, sewer, gas, electric) and easements
  - Estimates of unified stormwater sizing criteria requirements
  - Identification and calculation of stormwater site design credits
7. Hydrologic and hydraulic analysis including:
  - Selection and location of structural stormwater controls
  - Location of existing and proposed conveyance systems such as storm drains, inlets, catch basins, channels, swales, and areas of overland flow
  - Flow paths
  - Location of floodplain/floodway limits and relationship of site to upstream and downstream properties and drainages
  - Location and dimensions of proposed channel modifications, such as bridge or culvert crossings
8. Representative cross-section and profile drawings and details of structural stormwater controls and conveyances which include:
  - Dam safety and breach analysis, where necessary
  - Existing and proposed structural elevations (e.g., invert of pipes, manholes, etc.)
  - Design water surface elevations
  - Structural details of structural control designs, outlet structures, embankments, spillways, grade control structures, conveyance channels, etc.
9. Applicable construction specifications
10. Erosion and sediment control plan that at a minimum meets the requirements outlined in the Manual for Erosion and Sediment Control in Georgia
11. Landscaping plans for structural stormwater controls and any site reforestation or revegetation
12. Operations and maintenance plan that includes:
  - Name, legal address and phone number of responsible parties for maintenance activities
  - Description and schedule of maintenance tasks
  - Description of applicable easements
  - Description of funding source
  - Access and safety issues
  - Procedures for testing, removal, and disposal of sediments, if required
13. Evidence of acquisition of all applicable local and non-local permits
14. Waiver requests
15. Evidence of acquisition of all necessary legal agreements (e.g., easements, covenants, land trusts, etc.)

# Appendix C: Stormwater Construction Inspection Checklists

# Stormwater Management Construction Inspection Report for:

**Bioretention Basin; Bioslopes; Dry Wells; Infiltration Trenches; Organic Filters; Regenerative Stormwater Conveyance; Sand Filters; and Stormwater Planters/Tree Boxes**

Project Name and Address: \_\_\_\_\_ Contractor: \_\_\_\_\_  
 \_\_\_\_\_ Telephone #: \_\_\_\_\_  
 Project/File Number: \_\_\_\_\_ Inspector(s): \_\_\_\_\_  
 Date of Submittal: \_\_\_\_\_ Date: \_\_\_\_\_ Time: \_\_\_\_\_  
 Designer: \_\_\_\_\_ BMP Type: \_\_\_\_\_  
 Telephone #: \_\_\_\_\_

Inspection Items	Yes	No	N/A	Remarks
<b>Site Preparation:</b> Have erosion and sediment controls been properly installed according to approved plans?				
Is stormwater runoff being diverted around the facility?				
Has the contributing drainage area been fully stabilized?				
Is the area free of heavy equipment or items that can cause compaction?				
<b>Subgrade Preparation:</b> Is subgrade suitable? (free of debris, standing water, properly graded)				
Has compaction of the soils been avoided (for infiltration-based practices)?				
<b>BMP Geometry:</b> Are the BMP footprint and depth correct as shown on the plans?				
<b>Filter Fabric:</b> If called for in the plans, has the filter fabric been installed on the sides of the BMP only according to the specifications?				
<b>Underdrain:</b> If called for in the plans, has the underdrain been installed at the proper location and elevation?				
Are clean-outs installed as called for in the plans?				

# Stormwater Management Construction Inspection Report for: (con't)

Bioretention Basin; Bioslopes; Dry Wells; Infiltration Trenches; Organic Filters; Regenerative Stormwater Conveyance; Sand Filters; and Stormwater Planters/Tree Boxes

Inspection Items	Yes	No	N/A	Remarks
Are perforated/non-perforated sections of underdrain installed correctly?				
Is the observation well/outflow drain built according to plans and clean?				
Have the necessary precautions been taken to minimize clogging potential during construction?				
<b>Media Layer(s):</b> Do the stone, sand, mulch, and/or other planting media meet specifications? (attach certification)				
Have the media layers been installed to the design depths?				
<b>Surface:</b> Is the surface free of sediment, fines, and areas of clogging?				
<b>Embankment:</b> Is suitable fill material used for construction of the embankment/berm?				
<b>Vegetation:</b> Does the vegetation meet the plan requirements (if called for), and is it in good health?				
Do the plants meet the planting plan?				
Is the proper mulch depth present?				
<b>Pretreatment:</b> Are the pretreatment facilities installed according to the approved plans?				
<b>Inlets and Overflow:</b> Are inlet and overflow diameters/measurements correct according to the plans?				
Are inlet and overflow inverts at the correct elevation?				
<b>Final Inspection:</b> Can water infiltrate/filter properly into the BMP?				
Is the BMP complete and fully functional?				

# Stormwater Management Construction Inspection Report for:

## Downspout Disconnects; Site Reforestation/Revegetation; Soil Restoration; and Vegetated Filter Strips

Project Name and Address: \_\_\_\_\_ Contractor: \_\_\_\_\_  
 \_\_\_\_\_ Telephone #: \_\_\_\_\_  
 Project/File Number: \_\_\_\_\_ Inspector(s): \_\_\_\_\_  
 Date of Submittal: \_\_\_\_\_ Date: \_\_\_\_\_ Time: \_\_\_\_\_  
 Designer: \_\_\_\_\_ BMP Type: \_\_\_\_\_  
 Telephone #: \_\_\_\_\_

Inspection Items	Yes	No	N/A	Remarks
<b>Site Preparation:</b> Have erosion and sediment controls been properly installed according to approved plans?				
Do site excavation and grading conform to the plans?				
<b>Contributing Drainage Area:</b> Does the impervious area draining to the receiving pervious area match the plans?				
<b>Site Geometry:</b> Does the pervious area match the dimensions and slopes shown on the plan?				
<b>Level Spreader:</b> If called for on the plans, is the level spreader constructed at the proper elevation?				
<b>Vegetation:</b> Does the pervious area vegetation comply with the approved planting plan and specifications?				
Do the topsoil mixture, soil amendments, and/or soil compaction comply with the plans (if required)?				
<b>Final Inspection:</b> Have the contributing impervious area and the receiving pervious area been stabilized?				
Can water flow properly into the receiving pervious area (if called for on the plans)?				
Is the BMP complete and fully functional?				



# Stormwater Management Construction Inspection Report for:

**Dry Detention Basins; Dry Extended Detention Basins; Multi-Purpose Detention Basins; Stormwater Ponds; Stormwater Wetlands Level 1; Stormwater Wetlands Level 2; and Gravel Wetlands**

Project Name and Address: \_\_\_\_\_ Contractor: \_\_\_\_\_  
 \_\_\_\_\_ Telephone #: \_\_\_\_\_  
 Project/File Number: \_\_\_\_\_ Inspector(s): \_\_\_\_\_  
 Date of Submittal: \_\_\_\_\_ Date: \_\_\_\_\_ Time: \_\_\_\_\_  
 Designer: \_\_\_\_\_ BMP Type: \_\_\_\_\_  
 Telephone #: \_\_\_\_\_

Inspection Items	Yes	No	N/A	Remarks
<b>Site Preparation:</b> Have erosion and sediment controls been properly installed according to approved plans?				
<b>Contributing Drainage Area:</b> Has the contributing drainage area been fully stabilized?				
Does the area draining to the practice match the plans?				
<b>BMP Geometry:</b> Are the BMP dimensions correct as shown on the plans?				
Are the BMP side slopes constructed as called for on the plans?				
Is a geotextile or clay lining provided (where called for on the plans)?				
Is the BMP installed to the proper depth as shown on the plans?				
Are all internal features constructed as called for on the plans?				
Does the site have proper maintenance and inspection access?				
<b>Embankment:</b> Is suitable fill material used for construction of the embankment/berm?				
Is embankment properly compacted and at the proper elevation and slope?				
<b>Pretreatment:</b> Has the forebay or other pretreatment facility been installed according to the plans?				
<b>Inlets and Conveyance:</b> Have all inlets, flow paths, and underdrains (if called for) been properly installed and at the correct elevations?				

# Stormwater Management Construction Inspection Report for: (con't)

Dry Detention Basins; Dry Extended Detention Basins; Multi-Purpose Detention Basins; Stormwater Ponds; Stormwater Wetlands Level 1; Stormwater Wetlands Level 2; and Gravel Wetlands

Inspection Items	Yes	No	N/A	Remarks
<b>Outfall:</b> Has the outfall been constructed with adequate erosion protection as specified on the plans?				
Is an emergency spillway provided?				
<b>Overflow:</b> Has the riser or outflow structure been properly installed and at the correct elevations?				
<b>Pond Buffer/Vegetation (where applicable):</b> Do the buffer dimensions match the plans?				
Does the vegetation meet the plan requirements, and is it in good health?				
<b>Final Inspection:</b> Is the BMP complete and fully functional?				

# Stormwater Management Construction Inspection Report for:

## Enhanced Dry Swales; Enhanced Wet Swales; and Grass Channels

Project Name and Address: \_\_\_\_\_ Contractor: \_\_\_\_\_  
 \_\_\_\_\_ Telephone #: \_\_\_\_\_  
 Project/File Number: \_\_\_\_\_ Inspector(s): \_\_\_\_\_  
 Date of Submittal: \_\_\_\_\_ Date: \_\_\_\_\_ Time: \_\_\_\_\_  
 Designer: \_\_\_\_\_ BMP Type: \_\_\_\_\_  
 Telephone #: \_\_\_\_\_

Inspection Items	Yes	No	N/A	Remarks
<b>Site Preparation:</b> Have erosion and sediment controls been properly installed according to approved plans?				
Is stormwater runoff being diverted around the facility?				
Has the contributing drainage area been fully stabilized?				
<b>BMP Geometry:</b> Are the BMP dimensions and longitudinal slope correct as shown on the plans?				
Are the channel side slopes constructed as called for on the plans?				
Have the check dams been properly installed and to the correct elevations (where applicable)?				
<b>Filter Fabric:</b> If called for in the plans, has the filter fabric been installed on the sides of the BMP only according to the specifications?				
<b>Underdrain:</b> If called for in the plans, has the underdrain been installed at the proper location and elevation?				
Are clean-outs installed as called for in the plans?				
Are perforated/non-perforated sections of underdrain installed correctly?				
<b>Media Layer(s):</b> Do the stone, sand, mulch, and/or other media meet specifications? (attach certification)				

# Stormwater Management Construction Inspection Report for: (con't)

## Enhanced Dry Swales; Enhanced Wet Swales; and Grass Channels

Inspection Items	Yes	No	N/A	Remarks
Have the media layers been installed to the design depths?				
<b>Vegetation:</b> Does the pervious area vegetation comply with the approved planting plan and specifications?				
Do the topsoil mixture, soil amendments, and/or soil compaction comply with the plans (if required)?				
<b>Pretreatment:</b> Are the pretreatment facilities installed according to the approved plans?				
<b>Inlets and Overflow:</b> Are inlet and overflow inverts at the correct elevation?				
<b>Final Inspection:</b> Can water properly flow through/into the BMP?				
Is the BMP complete and fully functional?				

# Stormwater Management Construction Inspection Report for:

## Gravity Separators; Proprietary Systems; and Underground Detention

Project Name and Address: \_\_\_\_\_ Contractor: \_\_\_\_\_  
 \_\_\_\_\_ Telephone #: \_\_\_\_\_  
 Project/File Number: \_\_\_\_\_ Inspector(s): \_\_\_\_\_  
 Date of Submittal: \_\_\_\_\_ Date: \_\_\_\_\_ Time: \_\_\_\_\_  
 Designer: \_\_\_\_\_ BMP Type: \_\_\_\_\_  
 Telephone #: \_\_\_\_\_

Inspection Items	Yes	No	N/A	Remarks
<b>Site Preparation:</b> Have erosion and sediment controls been properly installed according to approved plans?				
<b>Subgrade Preparation:</b> Is subgrade suitable? (free of debris, standing water, properly graded)				
<b>Prefabricated Structure:</b> Does BMP conform to shop drawings? Do type and locations of openings meet the plan requirements?				
<b>Cast-In-Place Structure:</b> Does BMP conform to structural drawings? Does concrete meet strength and mix requirements? (attach certification)				
<b>Access:</b> Is access for each chamber provided as called for on the plans?				
<b>Inlet:</b> Is the inlet the correct size and elevation?				
<b>Internal Conveyance:</b> Are internal conveyance paths (underdrains, filter media, bypass) constructed as called for on the plans?				
<b>Overflow/Bypass:</b> Is the overflow or bypass constructed as called for in the plans?				
<b>Backfill:</b> Does the backfill soil meet the plans and specifications?				
<b>Final Inspection:</b> Is the BMP complete and fully functional?				

# Stormwater Management Construction Inspection Report for:

## Green Roofs

Project Name and Address: \_\_\_\_\_ Contractor: \_\_\_\_\_  
 \_\_\_\_\_ Telephone #: \_\_\_\_\_  
 Project/File Number: \_\_\_\_\_ Inspector(s): \_\_\_\_\_  
 Date of Submittal: \_\_\_\_\_ Date: \_\_\_\_\_ Time: \_\_\_\_\_  
 Designer: \_\_\_\_\_ BMP Type: \_\_\_\_\_  
 Telephone #: \_\_\_\_\_

Inspection Items	Yes	No	N/A	Remarks
<b>Deck Preparation:</b> Is the deck free of all trash, debris, grease, oil, water, and moisture?				
Are all concrete surfaces properly cured, dry, and free of voids, cracks, or holes?				
Is a leak detection device installed as called for on the plans?				
<b>Water Proofing:</b> Is the water proofing layer installed as called for on the plans?				
Has a water test or leak detection test been conducted?				
<b>Overflow Drains:</b> Are the overflow drains installed as called for on the plans?				
<b>Root Barrier:</b> Is the root barrier installed as called for on the plans?				
<b>Drainage Layer:</b> Is the drainage layer installed as called for on the plans?				
<b>Media:</b> Does the planting media meet the material and depth requirements on the plans?				
<b>Vegetation:</b> Does the vegetation meet the plan requirements, and is it in good health?				
<b>Irrigation:</b> Does the irrigation system meet plan specifications?				
<b>Final Inspection:</b> Is the BMP complete and fully functional?				



# Stormwater Management Construction Inspection Report for:

## Permeable Paver System; Pervious Concrete; and Porous Asphalt

Project Name and Address: \_\_\_\_\_ Contractor: \_\_\_\_\_  
 \_\_\_\_\_ Telephone #: \_\_\_\_\_  
 Project/File Number: \_\_\_\_\_ Inspector(s): \_\_\_\_\_  
 Date of Submittal: \_\_\_\_\_ Date: \_\_\_\_\_ Time: \_\_\_\_\_  
 Designer: \_\_\_\_\_ BMP Type: \_\_\_\_\_  
 Telephone #: \_\_\_\_\_

Inspection Items	Yes	No	N/A	Remarks
<b>Site Preparation:</b> Have erosion and sediment controls been properly installed according to approved plans?				
Is stormwater runoff being diverted around the facility?				
Has the contributing drainage area been fully stabilized?				
<b>Subgrade Preparation:</b> Is subgrade suitable? (free of debris, standing water, properly graded)				
Has subgrade been compacted as specified in the plans?				
<b>BMP Geometry:</b> Are the BMP dimensions correct as shown on the plans?				
<b>Filter Fabric:</b> If called for in the plans, has the filter fabric been installed on the sides of the BMP only according to the specifications?				
<b>Underdrain and Reservoir Layer:</b> If called for in the plans, does the underdrain meet the plan requirements with correct hole pattern, elevation, and slope?				
Does the stone reservoir meet the plan requirements (clean, washed, free of fines) and is it installed to design depth?				
<b>Surface Material:</b> Does the surface material meet the plan requirements and has it been properly installed?				
Is the surface even and can runoff spread evenly across it?				
Has the surface material had adequate curing time (for Porous Asphalt and Pervious Concrete)?				

# Stormwater Management Construction Inspection Report for: (con't)

Permeable Paver System; Pervious Concrete; and Porous Asphalt

Inspection Items	Yes	No	N/A	Remarks
Is the surface free of fines and areas of clogging?				
<b>Over Flow:</b> Have the overflow devices (where applicable) been installed at the correct elevation?				
<b>Final Inspection:</b> Can water infiltrate properly into the BMP?				
Does the reservoir storage layer drain within 48 hours?				
Is the BMP complete and fully functional?				

# Stormwater Management Construction Inspection Report for:

## Rainwater Harvesting

Project Name and Address: \_\_\_\_\_ Contractor: \_\_\_\_\_  
 \_\_\_\_\_ Telephone #: \_\_\_\_\_  
 Project/File Number: \_\_\_\_\_ Inspector(s): \_\_\_\_\_  
 Date of Submittal: \_\_\_\_\_ Date: \_\_\_\_\_ Time: \_\_\_\_\_  
 Designer: \_\_\_\_\_ BMP Type: \_\_\_\_\_  
 Telephone #: \_\_\_\_\_

Inspection Items	Yes	No	N/A	Remarks
<b>General:</b> Has the collection, treatment, and distribution system been designed and installed in accordance with the Georgia Rainwater Harvesting Guidelines?				
<b>Subgrade Preparation:</b> Has the subgrade been properly prepared and tank foundation installed as shown on plans?				
<b>Contributing Drainage Area:</b> Does the rooftop area draining to the tank match the plans?				
<b>Conveyance and Pretreatment:</b> Do the gutters match the plans with the correct sizing, elevation, and slope?				
Is the pretreatment or first flush diversion system properly sized and installed?				
Are mosquito screens properly installed on all tank openings?				
<b>Indoor Use:</b> If the collected water is to be used inside for toilet flushing or evaporative cooling, does the local building code allow that?				
Does the proposed treatment system meet the requirements of the Georgia Rainwater Harvesting Guidelines?				
Has the system been designed and installed in accordance with the Georgia State Amendments to the International Plumbing Code?				
<b>Pump System:</b> Have the pump (if applicable) and piping to end-uses (been properly installed?				

# Stormwater Management Construction Inspection Report for: (con't)

## Rainwater Harvesting

Inspection Items	Yes	No	N/A	Remarks
<b>Overflow:</b> Is the overflow device installed properly and at the correct elevation?				
<b>Final Inspection:</b> Is water conveyed into tank and to end-uses appropriately?				
Is the BMP complete and fully functional?				

# Appendix D: Example Stormwater Facility Maintenance Agreement

# Example Stormwater Facility Maintenance Agreement

STATE OF GEORGIA

[ENTER CITY OR COUNTY NAME]

AGREEMENT OF STORMWATER MANAGEMENT  
STORMWATER FACILITY AND  
GREEN INFRASTRUCTURE/LOW IMPACT DEVELOPMENT INTEGRATED MANAGEMENT PRACTICES (GI/LID IMPs)  
INSPECTION AND MAINTENANCE

WHEREAS, the property owner, \_\_\_\_\_ recognizes that the storm drain structures, pipes,  
*(Development Entity or Owner Name)*

water quality integrated management practices and all aspects of a stormwater management facility (hereinafter "stormwater management measures") must be maintained for the development called \_\_\_\_\_ of [CITY NAME], Georgia,  
*(Development Name)*

[COUNTY NAME] County, Georgia, being more particularly described by the legal description in Exhibit "A" attached hereto and made a part hereof; and,

WHEREAS, the property owner, \_\_\_\_\_, is the owner of the real property more particularly described  
*(Development Entity or Owner Name)*

on the attached Exhibit "B" - Development Plan (hereinafter referred to as "the property"), and,

WHEREAS, \_\_\_\_\_, whose title is \_\_\_\_\_, is the person responsible for  
*(Authorized Representative Name)*

carrying out all requirements of this Declaration and of the [CITY OR COUNTY NAME], Georgia Code and Area-wide MS4 stormwater management plan for the inspection and maintenance of the stormwater management measures on the property identified in Exhibit "B", and,

WHEREAS, the property owner, its administrators, executors, successors, heirs and assigns, agree that the health, safety and welfare of the citizens of the city require that stormwater management measures be constructed and maintained on the property to function as designed, and,

WHEREAS, the Stormwater Facility and GI/LID IMPs Inspection and Maintenance agreement(s) for the development called be recorded with \_\_\_\_\_ of [CITY NAME], Georgia, [COUNTYNAME] County, Georgia, shall  
*(Development Name)*

the [COUNTY NAME] County Clerk of Court and a copy of recorded agreement(s) provided to [CITY OF COUNTY DEPARTMENT NAME] prior to the release of a Certificate of Occupancy, and



## Example Stormwater Facility Maintenance Agreement: (con't)

WHEREAS, the [CITY OR COUNTY NAME], Georgia Code and Area-wide MS4 permit require that the stormwater management measures, as shown on the approved development plans and specifications, be constructed and maintained by the property owner, its administrators, executors, successors, heirs and assigns.

NOW, THEREFORE, in consideration of the foregoing premises and following terms and conditions, the undersigned agrees as follows:

### SECTION 1.

The stormwater management measures including GI/LID IMPs shall be constructed by the property owner in accordance with the plans and specifications for the development as submitted to and approved by the [ENTER CITY OF COUNTY NAME], Georgia (hereinafter "City OR County").

### SECTION 2.

The property owner, its administrators, executors, successors, heirs and assigns shall maintain all aspects of the stormwater management measures including GI/LID IMPs in good working condition acceptable to the City and in accordance with the development specific Inspection and Maintenance Procedures (as defined below) to ensure the control measures functioning as designed. A schedule of long term maintenance activities, including how often routine inspection and maintenance will occur, shall be in accordance with the attached Exhibit "C" (collectively, the "Inspection and Maintenance Procedures"). Such Schedule shall also include plans for annual inspections by a qualified inspector, as determined by the [CITY OR COUNTY DEPARTMENT NAME], to ensure proper performance of the facility between scheduled maintenance and remedies for the default thereof.

### SECTION 3.

The property owner shall establish a dedicated source of funding that will allow for a budget capable of covering the costs associated with maintenance, staff, equipment, and the repair and replacement of stormwater management measures including GI/LID IMPs components as necessary, and helps to ensure the continued functioning of IMPs as designed. The Property owner shall submit a copy of financial documentation (in form and substance as mutually agreed upon by the Property owner and the City OR County) confirming established dedicated source of funding to [CITY OF COUNTY DEPARTMENT NAME], if requested or prior to the release of a Certificate of Occupancy.

### SECTION 4.

The property owner, its administrators, executors, successors, heirs and assigns shall provide records of all inspections, maintenance and repairs of the stormwater management measures to the [CITY OF COUNTY DEPARTMENT NAME] on an annual basis, if requested. Such records include items inspected and details of maintenance and repairs performed.

## Example Stormwater Facility Maintenance Agreement: (con't)

### SECTION 5.

The property owner, its administrators, executors, successors, heirs and assigns hereby grants permission to the City OR County, its authorized agents and employees, to enter upon the property for regular inspections, periodic investigations, observation, measurement, enforcement, and sampling and testing of the stormwater management measures whenever the City deems necessary. Inspections may include, but are not limited to: reviewing maintenance and repair records; sampling discharges, surface water, groundwater, and material or water in stormwater management measures; and evaluating the condition of the stormwater management measures and practices. The City OR County, its authorized agents and employees, shall duly notify the owner of the property or the representative on site prior to such entry, except in the case of an emergency.

### SECTION 6.

In the event the property owner, its administrators, executors, successors, heirs and assigns fail to maintain the stormwater management measures according to the approved plans and the Maintenance and Inspection Schedule, the City OR County shall notify by certified mail the person specified herein as the person responsible for carrying out the maintenance plan. Such notice shall specify the measures necessary to comply with the site plans and the maintenance schedule and shall specify the amount of time (but in event less than thirty (30) days) within which such measures shall be completed. If the responsible person fails or refuses to meet the requirements of this Declaration, the City OR County, thirty (30) days (or the time set forth in the violation notice, whichever is greater) after the written notice is sent (except, that in the event the violation constitutes an immediate danger to public health or public safety, 24 hours notice shall be sufficient), may enter the property to correct a violation of the design standards or maintenance requirements by performing necessary work to place the facility or practice in proper working condition. The City OR County will assess the property owner or grantor for the cost of repair work. It is expressly understood that the City OR County is under no obligation to maintain or repair the stormwater management measures and in no event shall this Declaration be construed to impose any such obligation on the City OR County.

### SECTION 7.

It is the intent of this Declaration to ensure the proper maintenance of the stormwater management measures including GI/LID IMPs by the property owner; provided, however, that this Declaration shall not be deemed to create or affect any additional liability on the property owner for damage alleged to result from or caused by storm water runoff in addition to any such liability otherwise existing under applicable law.

### SECTION 8.

Sediment accumulation and other waste materials resulting from the operation of the stormwater management measures including IMPs shall be removed by the property owner. The property owner shall make arrangements at the property owner's expense for the removal and off-site disposal of all accumulated sediments and other waste materials.

## Example Stormwater Facility Maintenance Agreement: (con't)

### SECTION 9.

In the event the property owner sells or transfers the property, the transferring property owner shall provide to the [CITY OF COUNTY DEPARTMENT NAME], a Declaration of Transfer of Inspection and Maintenance Responsibilities of stormwater management measures including GI/LID IMPs signed by the transferring property owner and the transferee and witnessed by a public notary to document that all inspections and maintenance, and related financial responsibilities have been transferred and communicated to such transferee. Upon such transfer or conveyance of the property by the transferring property owner, all obligations of the transferring property owner hereunder shall automatically be transferred and assigned to, and assumed by transferee and such transferee shall and become the property owner under this Agreement.

### SECTION 10.

The property owner, its administrators, executors, successors, heirs and assigns hereby indemnifies and holds harmless the City OR County and its authorized agents and employees for any and all damages, accidents, casualties, occurrences or claims which may arise or be asserted against the City from the construction, presence, existence or maintenance of the stormwater management measures by the property owner or the City OR County, except to the extent caused by the gross negligence or willful misconduct of the City OR County or its authorized agents and employees. In the event a claim is asserted against the City OR County, its authorized agents or employees, the City OR County shall promptly notify the property owner and the property owner shall defend at its own expense any suit based on such claim, except as set forth in the foregoing sentence.

### SECTION 11.

This Agreement shall be recorded among the deed records of [COUNTY NAME] County and shall constitute a covenant running with the land shall be binding on the property owner. The City OR County will not release the Certificate of Occupancy for the property until such time that this agreement has been recorded with the [COUNTY NAME] County Clerk of Court.

### SECTION 12.

This Agreement may be enforced by proceedings at law or in equity by or against the undersigned and their respective successors in interest.

### SECTION 13.

Invalidation of anyone of the provisions of this Agreement shall in no way effect any other provision and all other provisions shall remain in full force and effect.

## Example Stormwater Facility Maintenance Agreement: (con't)

### SECTION 14.

This Agreement complies with the provisions of the City OR COUNTY of [City OR County Name] Code of Ordinances, Article [Article NUMBER AND TITLE] and [City OR County Name] MS4 Permit, Part 3, 3.3.10, and the property owner, its administrators, executors, successors, heirs and assigns acknowledge that it must obtain all required permits, submit all required plans and follow all provisions of Article [Article NUMBER AND TITLE]. Since under Article [Article NUMBER AND TITLE] the responsibility for the operation and maintenance of the stormwater management measures passes to any successor owner, this Declaration shall be binding on all subsequent owners of the property.

### SECTION 15.

Additional provisions that relate directly to the individual needs and requirements of this specific site plan as identified in Exhibit "A" and Exhibit "B" are attached hereto and made a part hereof. Such additional provisions have been discussed with and presented to the Augusta Engineering Department Director.

IN WITNESS WHEREOF, the Declarant has executed this Declaration on the \_\_\_\_\_ day of \_\_\_\_\_, 20\_\_\_\_.

Declarant:

Property Owner: \_\_\_\_\_  
(Development Entity or Owner Name)

Signed and Sealed

\_\_\_\_\_  
By: \_\_\_\_\_ (Seal)

Witness

\_\_\_\_\_  
Title: \_\_\_\_\_

Corporate Seal

\_\_\_\_\_  
Notary Public

EXHIBIT "A"	Property legal description
EXHIBIT "B"	Approved Development Plan
EXHIBIT "C"	Stormwater Management Measures Inspection and Maintenance Schedule

